



SAN FRANCISCO PLANNING DEPARTMENT

Executive Summary

Conditional Use

HEARING DATE: JANUARY 28, 2010
CONSENT CALENDAR

1650 Mission St.
Suite 400
San Francisco,
CA 94103-2479

Reception:
415.558.6378

Fax:
415.558.6409

Planning
Information:
415.558.6377

Date: January 21, 2010
Case No.: **2009.0251C**
Project Address: **1910 FILLMORE STREET**
Zoning: Upper Fillmore Street Neighborhood Commercial District (NCD)
40-X Height and Bulk District
Block/Lot: 0660/020
Project Sponsor: Jeremy Paul for Patama Roj and Jessica Gilmartin
Quickdraw Permit Consulting
60 Otis Street
San Francisco, CA 94103
Staff Contact: Sharon M. Young – (415) 558-6346
sharon.m.young@sfgov.org
Recommendation: **Approval with Conditions**

PROJECT DESCRIPTION

The proposal is a request for Conditional Use authorization under Sections 718.44, 186.1(c)(3)(A), and 303 of the Planning Code to allow the change of use of a full-service restaurant to a small self-service restaurant (dba Fraiche Yogurt Café) within the Upper Fillmore Street NCD and a 40-X Height and Bulk District.

From the 1980s until 2008, a full-service restaurant dba the Toraya Sushi Bar and Grill occupied the ground floor commercial space at 1910 - 1914 Fillmore Street. After that restaurant closed, the space was split into two spaces, with the northern space at 1914 Fillmore Street being occupied by a full-service restaurant dba the Woodhouse Fish Company. In mid-2008, the adjacent approximately 800 square-foot subject space at 1910 Fillmore Street was leased by Fraiche Yogurt which undertook tenant improvements and established its frozen yogurt business as a full-service restaurant with seating for up to 20 persons. Since the yogurt shop is more appropriately defined as a small self-service restaurant in Planning Code Section 790.91, the subject Conditional Use application was filed as required pursuant to Planning Code Section 186.1(c)(3)(A) to allow the change of use of a nonconforming full-service restaurant (all restaurants in the Upper Fillmore Street NCD are nonconforming uses) to another nonconforming restaurant category (in this case, a small self-service restaurant).

The hours of operation of the restaurant are 8 a.m. to 11 p.m. weekdays and 8 a.m. to midnight on weekends. The restaurant currently employs approximately 15 persons.

SITE DESCRIPTION AND PRESENT USE

The Project Site at 1910 Fillmore Street is located on the southeast corner of Fillmore and Wilmot Streets; Assessor's Block 0660; Lot 020. It is located within the Upper Fillmore Street Neighborhood Commercial Zoning District and a 40-X Height and Bulk District. The subject lot is 4,059 square-feet (50 feet wide by 81.25 feet deep) in size and is occupied by a three-story commercial and residential building. The proposed small self-service restaurant occupies one of three ground floor commercial spaces in the building. The other tenant commercial spaces are occupied by a full-service restaurant dba Woodhouse Fish Company at 1914 Fillmore Street and a jewelry company dba Linco & Co. at 1908 Fillmore Street.

SURROUNDING PROPERTIES & NEIGHBORHOOD

The surrounding development consists of a variety of commercial and mixed-use buildings mostly featuring residential uses above ground-floor commercial establishments. The scale of development in the area consists of a mix of low-and mid-rise buildings (one- to three-story structures), some of which were built in the early 1900s. Generally, the commercial establishments characterizing this portion of Fillmore Street include a mixture of restaurants, apparel/accessory stores and specialty shops, and medical and personal service establishments. Some of the existing commercial establishments on the subject and opposite blocks include Johnny Rockets, Caltrin Tran Boutique, a psychotherapy office, Fillmore Hardward, Woodhouse Fish Co, Linco & Co, New Asian Style contemporary collection specialty store, Makuya Sushi restaurant, a nail salon, Bead & Shells, Sterling Bank & Trust, Crossroads Trading Co., Zinc Details Design store, DZ specialty store, Invision Optometry, Perfect Cleaners, SPQR restaurant, Design Within Reach, Florio Café restaurant, Ruby Living Design, Osaka restaurant, Paper Source, and Shu Yemura cosmetic store. The surrounding zoning is primarily Upper Fillmore Street NCD, RH-2 (Residential, House, Two-Family) District, NC-3 (Moderate-Scale Neighborhood Commercial) District, and RM-1 (Residential, Mixed, Low-Density) District zoning.

ENVIRONMENTAL REVIEW

The proposed project was determined by the San Francisco Planning Department to be categorically exempt from environmental review, under Class 1(a) of the State CEQA Guidelines, Section 15301, pursuant to Title 14 of the California Administrative Code.

HEARING NOTIFICATION

TYPE	REQUIRED PERIOD	REQUIRED NOTICE DATE	ACTUAL NOTICE DATE	ACTUAL PERIOD
Classified News Ad	20 days	January 8, 2010	January 8, 2010	20 days
Posted Notice	20 days	January 8, 2010	January 8, 2010	20 days
Mailed Notice	20 days	January 8, 2010	January 6, 2010	22 days

PUBLIC COMMENT

- As of January 21, 2010, the Department has not received any letters or phone calls in opposition to the project. The agent has contacted the Pacific Heights Residents Association and Fillmore Street Merchants Association and indicated that they have received positive feedback in regards to their proposed project.

ISSUES AND OTHER CONSIDERATIONS

- The restaurant dba Fraiche Yogurt Café is independently owned and is not considered a formula retail use under Section 703.3 of the Planning Code. Fraiche is a homemade, organic fresh yogurt and frozen yogurt café. According to the project sponsor, all of their European-style yogurts are made from scratch, in-house using local Clover organic milk and a special probiotic-focused culture. In addition to yogurt, Fraiche Yogurt Cafe also serves oatmeal, baked goods, and coffee products. There are two other Fraiche Yogurt Cafe restaurants located in the San Francisco Bay Area (both in Palo Alto).
- The proposal will not involve tenant improvements to the existing ground floor commercial space or any expansion of the existing building envelope associated with this Conditional Use Application. The storefront and tenant improvements were issued for the frozen yogurt business as a full-service restaurant use under Building Permit Application Nos. 2009.07.02.1900, 2009.07.30.3794, and 2009.08.19.5186.
- Public transit that is in close proximity to the proposed small self-service restaurant includes Muni Lines 3 and 22 on the corner of Fillmore and Pine Streets. There is on-street parking in front of the subject property and in the surrounding neighborhood.

REQUIRED COMMISSION ACTION

This proposal requires **Conditional Use** authorization pursuant Sections 718.44, 186.1(c)(3)(A), and 303 of the Planning Code. This Conditional Use authorization is to allow the change of use of a full-service restaurant to a small self-service restaurant (dba Fraiche Yogurt Café) within the Upper Fillmore Street NCD and a 40-X Height and Bulk District.

BASIS FOR RECOMMENDATION

- The proposed project will allow the change of use of a yogurt shop which was first established as a full-service restaurant to the more appropriate small self-service restaurant category. The proposed project will continue to occupy a previously vacant commercial tenant space on the subject block which is complimentary to the mix of existing neighborhood-serving uses within the neighborhood. It will also allow for the retention of new job opportunities to the City.
- The proposed project meets all applicable requirements of the Planning Code.
- The Department believes that this project is necessary and/or desirable for the following reasons:
 - a) The proposed project will enhance the economic diversity of the neighborhood by allowing the retention of a new business in the area.
 - b) The proposed project is a neighborhood-serving use which local residents can access by walking or taking public transit.
 - c) The proposed project is consistent with the mixed commercial-residential character of the Upper Fillmore Street NCD.

RECOMMENDATION: Approval with Conditions
--

Attachment Checklist

- | | |
|---|---|
| <input checked="" type="checkbox"/> Executive Summary | <input checked="" type="checkbox"/> Project sponsor submittal |
| <input checked="" type="checkbox"/> Draft Motion | Drawings: <u>Existing Conditions</u> |
| <input type="checkbox"/> Environmental Determination | <input checked="" type="checkbox"/> Check for legibility |
| <input checked="" type="checkbox"/> Zoning District Map | Drawings: <u>Proposed Project</u> |
| <input type="checkbox"/> Height & Bulk Map | <input checked="" type="checkbox"/> Check for legibility |
| <input checked="" type="checkbox"/> Parcel Map | <input type="checkbox"/> |
| <input checked="" type="checkbox"/> Sanborn Map | <input type="checkbox"/> |
| <input checked="" type="checkbox"/> Aerial Photo | <input type="checkbox"/> |
| <input checked="" type="checkbox"/> Context Photos | <input type="checkbox"/> |
| <input checked="" type="checkbox"/> Site Photos | <input type="checkbox"/> |

Exhibits above marked with an "X" are included in this packet

SMY
Planner's Initials

SMY: C:\1910 Fillmore Street - summary-smy.doc



SAN FRANCISCO PLANNING DEPARTMENT

Subject to: (Select only if applicable)

- Inclusionary Housing (Sec. 315)
- Jobs Housing Linkage Program (Sec. 313)
- Downtown Park Fee (Sec. 139)
- First Source Hiring (Admin. Code)
- Child Care Requirement (Sec. 314)
- Other

1650 Mission St.
Suite 400
San Francisco,
CA 94103-2479

Reception:
415.558.6378

Fax:
415.558.6409

Planning
Information:
415.558.6377

Planning Commission Motion No.

HEARING DATE: JANUARY 28, 2010

Date: January 21, 2010
Case No.: **2009.0251C**
Project Address: **1910 FILLMORE STREET**
Zoning: Upper Fillmore Street Neighborhood Commercial District (NCD)
 40-X Height and Bulk District
Block/Lot: 0660/020
Project Sponsor: Jeremy Paul for Patama Roj and Jessica Gilmartin
 Quickdraw Permit Consulting
 60 Otis Street
 San Francisco, CA 94103
Staff Contact: Sharon M. Young – (415) 558-6346
sharon.m.young@sfgov.org

ADOPTING FINDINGS RELATED TO THE APPROVAL OF A CONDITIONAL USE AUTHORIZATION UNDER PLANNING CODE SECTIONS 718.44, 186.1(c)(3)(A), AND 303 OF THE PLANNING CODE TO ALLOW THE CHANGE OF USE OF A FULL-SERVICE RESTAURANT TO A SMALL SELF-SERVICE RESTAURANT (DBA FRAICHE YOGURT CAFÉ) AT 1910 FILLMORE STREET ON ASSESSOR’S BLOCK 0660, LOT 020 WITHIN THE UPPER FILLMORE STREET NEIGHBORHOOD COMMERCIAL ZONING DISTRICT AND A 40-X HEIGHT AND BULK DISTRICT.

PREAMBLE

On March 31, 2009, Jeremy Paul acting agent on behalf of Patama Roj and Jessica Gilmartin (hereinafter “Project Sponsor”) made an application for Conditional Use authorization for the property at **1910 Fillmore Street, Lot 020 in Assessor’s Block 0660** (hereinafter “Subject Property”), to allow the change of use of an approximately 800 square-foot full-service restaurant to a small self-service restaurant (dba Fraiche Yogurt Café) on the ground floor of the three-story commercial and residential building within the Upper Fillmore Street NCD and a 40-X Height and Bulk District, in general conformity with plans dated September 9, 2009 and labeled “Exhibit B” (hereinafter “Project”).

On **January 28, 2010**, the San Francisco Planning Commission (hereinafter “Commission”) conducted a duly noticed public hearing at a regularly scheduled meeting on **Conditional Use Application No. 2009.0251C**. Under Sections 718.44, 186.1(c)(3)(A), and 303 of the Planning Code, Conditional Use authorization is required to allow the change of use of a nonconforming full-service restaurant (all

restaurants in the Upper Fillmore Street NCD are nonconforming uses) to another nonconforming restaurant category (in this case, a small self-service restaurant).

Pursuant to the Guidelines of the State Secretary of Resources for the implementation of the California Environmental Quality Act (hereinafter "CEQA"), the Planning Department of the City and County of San Francisco (hereinafter "Department") determined that the proposed Conditional Use Application was categorically exempt from the environmental review process under Class 1(a) of the State CEQA Guidelines, Section 15301, pursuant to Title 14 of the California Administrative Code. The Commission has reviewed and concurs with said determination.

The Commission has heard and considered the testimony presented to it at the public hearing and has further considered written materials and oral testimony presented on behalf of the applicant, Department staff, and other interested parties.

MOVED, that the Commission hereby authorizes the Conditional Use requested in Application No. 2009.0251C, subject to the conditions contained in "EXHIBIT A" of this motion, based on the following findings:

FINDINGS

Having reviewed the materials identified in the recitals above, and having heard all testimony and arguments, this Commission finds, concludes, and determines as follows:

1. The above recitals are accurate and constitute findings of this Commission.
2. **Site Description and Present Use.** The Project Site at 1910 Fillmore Street is located on the southeast corner of Fillmore and Wilmot Streets; Assessor's Block 0660; Lot 020. It is located within the Upper Fillmore Street NCD and a 40-X Height and Bulk District. The subject lot is 4,059 square-feet (50 feet wide by 81.25 feet deep) in size and is occupied by a three-story commercial and residential building. The proposed small self-service restaurant occupies one of three ground floor commercial spaces in the building. The other tenant commercial spaces are occupied by a full-service restaurant dba Woodhouse Fish Company at 1914 Fillmore Street and a jewelry company dba Linco & Co. at 1908 Fillmore Street.
3. **Surrounding Properties and Neighborhood.** The surrounding development consists of a variety of commercial and mixed-use buildings mostly featuring residential uses above ground-floor commercial establishments. The scale of development in the area consists of a mix of low-and mid-rise buildings (one- to three-story structures), some of which were built in the early 1900s. Generally, the commercial establishments characterizing this portion of Fillmore Street include a mixture of restaurants, apparel/accessory stores and specialty shops, and medical and personal service establishments. Some of the existing commercial establishments on the subject and opposite blocks include Johnny Rockets, Caltrin Tran Boutique, a psychotherapy office, Fillmore Hardward, Woodhouse Fish Co, Linco & Co, New Asian Style contemporary collection specialty store, Makuya Sushi restaurant, a nail salon, Bead & Shells, Sterling Bank & Trust, Crossroads

Trading Co., Zinc Details Design store, DZ specialty store, Invision Optometry, Perfect Cleaners, SPQR restaurant, Design Within Reach, Florio Café restaurant, Ruby Living Design, Osaka restaurant, Paper Source, and Shu Yemura cosmetic store. The surrounding zoning is primarily Upper Fillmore Street NCD, RH-2 (Residential, House, Two-Family) District, NC-3 (Moderate-Scale Neighborhood Commercial) District, and RM-1 (Residential, Mixed, Low-Density) District zoning.

4. **Project Description.** The proposal is a request for Conditional Use authorization under Sections 718.44, 186.1(c)(3)(A), and 303 of the Planning Code to allow the change of use of a full-service restaurant to a small self-service restaurant (dba Fraiche Yogurt Café) within the Upper Fillmore Street NCD and a 40-X Height and Bulk District.

From the 1980s until 2008, a full-service restaurant dba the Toraya Sushi Bar and Grill occupied the ground floor commercial space at 1910 - 1914 Fillmore Street. After that restaurant closed, the space was split into two spaces, with the northern space at 1914 Fillmore Street being occupied by a full-service restaurant dba the Woodhouse Fish Company. In mid-2008, the adjacent approximately 800 square-foot subject space at 1910 Fillmore Street was leased by Fraiche Yogurt which undertook tenant improvements and established its frozen yogurt business as a full-service restaurant with seating for up to 20 persons. Since the yogurt shop is more appropriately defined as a small self-service restaurant in Planning Code Section 790.91, the subject Conditional Use application was filed as required pursuant to Planning Code Section 186.1(c)(3)(A) to allow the change of use of a nonconforming full-service restaurant (all restaurants in the Upper Fillmore Street NCD are nonconforming uses) to another nonconforming restaurant category (in this case, a small self-service restaurant). The proposal will not involve tenant improvements to the ground floor commercial space, with no expansion of the existing building envelope.

5. **Issues and Other Considerations.**

- The restaurant dba Fraiche Yogurt Café is independently owned and is not considered a formula retail use under Section 703.3 of the Planning Code. Fraiche is a homemade, organic fresh yogurt and frozen yogurt café. According to the project sponsor, all of their European-style yogurts are made from scratch, in-house using local Clover organic milk and a special probiotic-focused culture. In addition to yogurt, Fraiche Yogurt Cafe also serves oatmeal, baked goods, and coffee products. There are two other Fraiche Yogurt Cafe restaurants located in the San Francisco Bay Area (both in Palo Alto).
- The proposal will not involve tenant improvements to the existing ground floor commercial space or any expansion of the existing building envelope associated with this Conditional Use Application. The storefront and tenant improvements were issued for the frozen yogurt business as a full-service restaurant use under Building Permit Application Nos. 2009.07.02.1900, 2009.07.30.3794, and 2009.08.19.5186.
- Public transit that is in close proximity to the proposed small self-service restaurant includes Muni Lines 3 and 22 on the corner of Fillmore and Pine Streets. There is on-

street parking in front of the subject property and in the surrounding neighborhood. There is on-street parking in front of the subject property and in the surrounding neighborhood.

6. **Public Comment.** As of January 21, 2010, the Department has not received any letters or phone calls in opposition to the project. The agent has contacted the Pacific Heights Residents Association and Fillmore Street Merchants Association and indicated that they have received positive feedback in regards to their proposed project.
7. **Use District.** For the purposes of this action, the project site is within the Upper Fillmore Street Neighborhood Commercial District (NCD). The Upper Fillmore Street NCD is situated in the south-central portion of Pacific Heights. It runs north-south along Fillmore Street from Jackson to Bush and extends west one block along California and Pine Streets. This medium-scaled, multi-purpose commercial district provides convenience goods to its immediate neighborhood as well as comparison shopping goods and services on a specialized basis to a wider trade area. Commercial businesses are active during both day and evening and include a number of bars, restaurants, specialty groceries, and specialty clothing stores.
8. **Planning Code Compliance:** The Commission finds that the Project is consistent with the relevant provisions of the Planning Code in the following manner:
 - A. **Section 101.1(b)** establishes eight priority planning policies and requires the review of permits that authorize changes of use for consistency with said policies:
 - (1) That existing neighborhood-serving retail uses be preserved and enhanced and future opportunities for resident employment in and ownership of such businesses enhanced.

The proposed Project will continue to preserve and enhance the District's existing commercial uses by providing a small self-service restaurant use which is complimentary to the existing commercial establishments within the immediate neighborhood. The proposed Project currently provides job opportunities to the City by employing approximately 15 people and will continue to do so as a small self-service restaurant.
 - (2) That existing housing and neighborhood character be conserved and protected in order to preserve the cultural and economic diversity of our neighborhoods.

The proposed Project will preserve and enhance the cultural and economic diversity of the neighborhood by retaining a new business in the area. Existing housing will not be affected by the proposed Project.
 - (3) That the City's supply of affordable housing be preserved and enhanced.

The proposed Project will not displace any affordable housing.
 - (4) That commuter traffic not impede MUNI transit service or overburden our streets or neighborhood parking.

The proposed Project would not significantly increase the automobile traffic congestion and parking problems in the neighborhood. The proposal is a neighborhood-serving use which residents can access by walking or taking public transit.

- (5) That a diverse economic base be maintained by protecting our industrial and service sectors from displacement due to commercial office development, and that future opportunities for resident employment and ownership in these sectors be enhanced.

There is no commercial office development associated with the proposed Project and there would be no displacement of any existing industrial or service businesses in the area.

- (6) That the City achieves the greatest possible preparedness to protect against injury and loss of life in an earthquake.

The proposed Project will comply with all applicable earthquake safety standards and built to the current standards of the California Building Code.

- (7) That landmark and historic buildings be preserved.

The proposed Project will not affect any landmarks or historic buildings.

- (8) That our parks and open space and their access to sunlight and vistas be protected from development.

The proposed Project will not affect any city-owned park or open space.

- B. **Section 186.1(c)(3)(A)** allows a nonconforming use to be changed to another use which is non-permitted in that Neighborhood Commercial District only upon approval of a conditional use application.

The proposed Project requires Conditional Use authorization to allow the change of use of a nonconforming full-service restaurant (all restaurants in the Upper Fillmore Street NCD are nonconforming uses) to another nonconforming restaurant category (in this case, a small self-service restaurant).

- C. **Section 303(c)** establishes criteria for the Planning Commission to consider when reviewing applications for Conditional Use approval. On balance, the project does comply with said criteria in that:

- (1) The proposed new uses and building, at the size and intensity contemplated and at the proposed location, will provide a development that is necessary or desirable, and compatible with, the neighborhood or the community.

The proposed Project will allow for the change of use of a full-service restaurant use to a small self-service restaurant use at the Project Site. The proposed Project is necessary and desirable because it currently occupies what would otherwise be a vacant commercial space on the subject block. There will be no additional tenant improvements made to the existing commercial tenant space or changes made to the existing building envelope.

- (2) The proposed project will not be detrimental to the health, safety, convenience or general welfare of persons residing or working in the vicinity. There are no features of the project that could be detrimental to the health, safety or convenience of those residing or working the area, in that:

- (A) Nature of proposed site, including its size and shape, and the proposed size, shape and arrangement of structures;

The size and shape of the site and the size, and the arrangement of the structures on the site are adequate for the proposed Project. There will be no physical expansion of the existing building.

- (B) The accessibility and traffic patterns for persons and vehicles, the type and volume of such traffic, and the adequacy of proposed off-street parking and loading;

Existing traffic patterns will not be significantly affected by the proposed Project. Public transit that is in close proximity to the restaurant includes Muni Line 3 and 22 within walking distance of the Project Site. There is on-street parking in front of the subject property and in the surrounding neighborhood.

- (C) The safeguards afforded to prevent noxious or offensive emissions such as noise, glare, dust and odor;

No noxious or offensive emissions such as glare, dust, or odor are expected to be produced by the proposed Project.

- (D) Treatment given, as appropriate, to such aspects as landscaping, screening, open spaces, parking and loading areas, service areas, lighting and signs;

The existing building, like many other commercial buildings on the block, occupies a majority of the site; no landscaping is provided on site. There will be no addition of parking spaces, loading facilities, open space or service areas. All Project signage and projections will be consistent with the controls of the Planning Code.

- (3) That the use as proposed will comply with the applicable provisions of the Planning Code and will not adversely affect the General Plan.

The proposed Project complies with all relevant requirements and standards of the Planning Code and is consistent with objectives and policies of the General Plan as detailed below.

- (4) That the use as proposed would provide development that is in conformity with the purpose of the applicable Neighborhood Commercial District.

The proposed Project is consistent with the stated purpose of the Upper Fillmore Street NCD in that the intended use is a neighborhood-serving business.

D. **Section 718.1** sets forth provisions applicable in the Upper Fillmore Street Neighborhood Commercial Zoning District. The Upper Fillmore Street District controls are designed to protect the existing building scale and promote new mixed-use development which is in character with adjacent buildings. Building standards regulate large lot and use development and protect rear yards above the ground story and at residential levels. Most commercial uses are permitted at the first two stories of new buildings. Special controls are designed to preserve the existing equilibrium of neighborhood-serving convenience and specialty commercial uses. In order to maintain convenience stores and protect adjacent livability, additional eating and drinking establishments are prohibited and ground-story entertainment and financial service uses are limited. In order to promote continuous retail frontage, drive-up and most automobile uses are prohibited. Housing development in new buildings is encouraged above the second story. Existing residential units are protected by limitations on demolitions and upper-story conversions.

E. **Section 718.27** allows hours of operation from 6 a.m. until 2 a.m. as of right and requires Conditional Use authorization to operate between the hours of 2 a.m. and 6 a.m.

The hours of operation of the restaurant are 8 a.m. to 11 p.m. weekdays and 8 a.m. to midnight on weekends.

F. **Section 718.44** allows a small self-service restaurant use in the Upper Fillmore Street NCD with Conditional Use authorization as described in Section 186.1(c)(3)(A).

The proposal is to allow the change of use of a nonconforming full-service restaurant to a non-conforming small self-service restaurant use on the Project Site.

9. **General Plan Compliance.** The Project is consistent with the Objectives and Policies of the General Plan in that:

COMMERCE AND INDUSTRY ELEMENT

GENERAL/CITYWIDE

OBJECTIVE 1:

MANAGE ECONOMIC GROWTH AND CHANGE TO ENSURE ENHANCEMENT OF THE TOTAL CITY LIVING AND WORKING ENVIRONMENT.

Policy 1:

Encourage development which provides substantial net benefits and minimizes undesirable consequences. Discourage development, which has substantial undesirable consequences that cannot be mitigated.

The proposed small self-service restaurant use would be compatible with and complimentary to the types of uses characterizing this portion of the Upper Fillmore Street NCD, which include a mixture of restaurants, apparel/accessory stores and specialty shops, and medical and personal service establishments.

Policy 3:

Preserve and promote the mixed commercial-residential character in neighborhood commercial districts. Strike a balance between the preservation of affordable housing and the needed expansion of commercial activity.

Approval of the proposed Project would be consistent with the mixed commercial-residential character of the Upper Fillmore Street NCD. The proposed Project would not adversely impact any affordable housing resources in the neighborhood.

OBJECTIVE 3:

PROVIDE EXPANDED EMPLOYMENT OPPORTNITIES FOR CITY RESIDENTS, PARTICULARLY THE UNEMPLOYED AND ECONOMICALLY DISADVANTAGED.

Policy 1:

Promote measures designed to increase the number of San Francisco jobs held by San Francisco residents.

The proposed Project will continue to provide enhanced opportunities for employment of neighborhood residents.

NEIGHBORHOOD COMMERCE

Objectives and Policies

OBJECTIVE 6:

MAINTAIN AND STRENGTHEN VIABLE NEIGHBORHOOD COMMERCIAL AREAS EASILY ACCESSIBLE TO CITY RESIDENTS.

Policy 4:

Encourage the location of neighborhood shopping areas throughout the city so that essential retail goods and personal services are accessible to all residents.

The proposed Project will provide a small-self service restaurant use which is accessible to all residents in this portion of the Upper Fillmore Street NCD.

Policy 9:

Regulate uses so that traffic impacts and parking problems are minimized.

The proposed Project does not adversely impact public transit or place a burden on the existing supply of parking in the neighborhood. Many patrons are able to walk from their residences or places of employment, and the project is well served by public transportation. There is on-street parking in front of the subject property and in the surrounding neighborhood.

URBAN DESIGN ELEMENT

CITY PATTERN

Objectives and Policies

OBJECTIVE 1:

EMPHASIS OF THE CHARACTERISTIC PATTERN WHICH GIVES TO THE CITY AND ITS NEIGHBORHOODS AN IMAGE, A SENSE OF PURPOSE AND A MEANS OF ORIENTATION.

Policy 3:

Recognize that buildings, when seen together, produce a total effect that characterizes the City and its districts.

The Project's design would preserve the existing neighborhood character since the proposal does not include any major facade and exterior changes.

NEIGHBORHOOD ENVIRONMENT

Objectives and Policies

OBJECTIVE 4:

IMPROVEMENT OF THE NEIGHBORHOOD ENVIRONMENT TO INCREASE PERSONAL SAFETY, COMFORT, PRIDE AND OPPORTUNITY.

Policy 15:

Protect the livability and character of residential properties from the intrusion of incompatible new buildings.

The proposed Project would improve the neighborhood environment by increasing safety during the daytime through the continued occupancy of a previously vacant commercial tenant space.

10. The Project is consistent with and would promote the general and specific purposes of the Code provided under Section 101.1(b) in that, as designed, the Project would contribute to the character and stability of the neighborhood and would constitute a beneficial development.
11. The Commission hereby finds that approval of the Conditional Use authorization would promote the health, safety and welfare of the City.

DECISION

That based upon the Record, the submissions by the Applicant, the staff of the Department and other interested parties, the oral testimony presented to this Commission at the public hearings, and all other written materials submitted by all parties, the Commission hereby **APPROVES Conditional Use Application No. 2009.0251C** subject to the following conditions attached hereto as "EXHIBIT A" which is incorporated herein by reference as though fully set forth.

APPEAL AND EFFECTIVE DATE OF MOTION: Any aggrieved person may appeal this Conditional Use Authorization to the Board of Supervisors within thirty (30) days after the date of this Motion. The effective date of this Motion shall be the date of this Motion if not appealed (After the 30-day period has expired) OR the date of the decision of the Board of Supervisors if appealed to the Board of Supervisors. For further information, please contact the Board of Supervisors at (415) 554-5184, City Hall, Room 244, 1 Dr. Carlton B. Goodlett Place, San Francisco, CA 94102.

I hereby certify that the Planning Commission ADOPTED the foregoing Motion on January 28, 2010.

Linda Avery
Commission Secretary

AYES:

NAYS:

ABSENT:

ADOPTED:

Exhibit A

Conditions of Approval

APPROVED USE CONDITIONS

1. Pursuant to Sections 718.44, 186.1(c)(3)(A), and 303 of the Planning Code, this Conditional Use approval is to allow the change of use of an approximately 800 square-foot full-service restaurant to a small self-service restaurant (dba Fraiche Yogurt Café) within the Upper Fillmore Street Neighborhood Commercial Zoning District and a 40-X Height and Bulk District, in general conformity with Plans on file with the Department in the docket for **Case No. 2009.0251C** (labeled EXHIBIT B), reviewed and approved by the Commission on January 28, 2010 under Motion No. _____.
2. From the 1980s until 2008, a full-service restaurant dba the Toraya Sushi Bar and Grill occupied the ground floor commercial space at 1910 - 1914 Fillmore Street. After that restaurant closed, the space was split into two spaces, with the northern space at 1914 Fillmore Street being occupied by a full-service restaurant dba the Woodhouse Fish Company. In mid-2008, the adjacent approximately 800 square-foot subject space at 1910 Fillmore Street was leased by Fraiche Yogurt which undertook tenant improvements and established its frozen yogurt business as a full-service restaurant with seating for up to 20 persons. Since the yogurt shop is more appropriately defined as a small self-service restaurant in Planning Code Section 790.91, the subject Conditional Use application was filed as required pursuant to Planning Code Section 186.1(c)(3)(A) to allow the change of use of a nonconforming full-service restaurant (all restaurants in the Upper Fillmore Street NCD are nonconforming uses) to another nonconforming restaurant category (in this case, a small self-service restaurant). The proposal will not involve tenant improvements to the ground floor commercial space, with no expansion of the existing building envelope.
3. The proposed hours of operation of the small self-service restaurant are 8 a.m. to 11 p.m. Monday through Friday, and 8 a.m. to midnight on Saturday and Sunday.
4. The property owner shall maintain the main entrance to the building and all sidewalks abutting the Subject Property in a clean condition. Such maintenance shall include, at a minimum, daily litter pickup and disposal, and washing or steam cleaning of the main entrance and abutting sidewalks at least once each week.
5. Noise and odors shall be contained within the proposed small self-service restaurant premises so as not to be a nuisance to nearby residences and businesses.
6. Signs and exterior lighting for the business shall be reviewed and approved by the Planning Department before they are installed.

STANDARD CONDITIONS

7. VALIDITY, EXPIRATION, AND EXTENSION

This Conditional Use approval is **valid for three years** from the effective date of the Motion No. _____ authorizing the proposed small self-service restaurant use and shall automatically

expire on _____. This authorization is just an approval of the proposed use and is NOT a permit to implement the approved use. This authorization and right vested by virtue of this action shall be deemed void and cancelled if a Building Permit from the Department of Building Inspection to implement the approved use has not been obtained prior to the expiration of this Conditional Use approval. The validity of this Conditional Use approval may be extended at the discretion of the Zoning Administrator only if the failure to issue a Building Permit by the Department of Building Inspection is delayed by the city, state, or federal agency or by appeal of the issuance of such Building Permit. However, the extension must be requested prior to the expiration of this Conditional Use approval.

8. MAJOR AND MINOR CHANGES AND MODIFICATIONS OF CONDITIONS

Minor changes to the approved plans may be approved administratively by the Zoning Administrator. Major changes and modifications of conditions shall be subject to review and approval by the Planning Commission requiring a new Conditional Use approval or amendment to this Conditional Use approval as determined by the Zoning Administrator. Such changes must be requested prior to the expiration of this Conditional Use approval.

9. RECORDING OF CONDITIONS OF APPROVAL

Prior to the issuance of a Building Permit Application for the proposed small self-service restaurant use, the project sponsor or the responsible party shall record a Notice of Special Restrictions as approved by the Zoning Administrator in the Official Records of the Recorder of City and County of San Francisco for the premises (Assessor's 0660, Lot 020), which notice shall state that the proposed use has been authorized by Motion No. _____ and is subject to the conditions of approval of this Motion.

10. BUILDING PERMIT TO IMPLEMENT THE APPROVED PROJECT

A Building Permit from the Department of Building Inspection must be obtained to implement the approved use within three years from the effective date of Motion No. _____ approving the proposed small self-service restaurant use. The Building Permit Application shall include plans in conformance with the plans on file with the Department in the docket for **2009.0251C** (labeled EXHIBIT B), reviewed and approved by the Planning Commission on January 28, 2010 under the **Motion No. _____**. The plans are required to record the approved use of the premises even if there is no new construction or minor interior changes. The conditions of approval shall be reproduced on the Index Sheet of the plans submitted with the Building Permit Application. The Index Sheet of the plans shall reference to this Conditional Use Authorization and any subsequent amendments or modifications.

The project shall also comply with all other applicable city codes as required by other city departments. Additionally, no change in the character of occupancy or change to a different group of occupancy as described under the Building Code shall be made without first obtaining a Certificate of Occupancy from the Department of Building Inspection and approval from Planning and other city departments as necessary.

11. COMPLETION OF BUILDING PERMIT

The completion of Building Permit with a final inspection and/or issuance of a Certificate of Final Completion and Certificate of Occupancy from the Department of Building Inspection for the approved use under this project shall be deemed acceptance and agreement to fully comply with all of the conditions of approval of this Conditional Use approval. The project sponsor or the responsible party must ensure that the Building Permit Application has attained a 'complete' stage within the time frame required by the Department of Building Inspection. If the Building Permit is allowed to expire for more than one year, the renewal of such Building Permit thereafter will be subject to review by the Planning Department. Prior to filing of a renewal of the expired permit, the project sponsor or the responsible party shall notify the Planning Department.

12. REPORTING

The Project Sponsor or the subsequent responsible party for the project shall submit to the Zoning Administrator two copies of a written report describing the status of compliance with the conditions of approval contained within the Motion No. _____ within six months from the date of implementation of the proposed use. Thereafter, the submittal of the report shall be on an annual basis. This requirement shall lapse when the Zoning Administrator determines that all the conditions of approval have been satisfied or that the report is no longer required for other reasons.

13. REVOCATION

During the Building Permit Application process phase of the project, the Zoning Administrator may place an order to stop work, suspend, or revoke a Building Permit if the proposal carried out on the site is not in conformance with the plans approved under this Conditional Use approval and subsequent Building Permit. The Zoning Administrator may also recommend the Planning Commission to consider revocation of this Conditional Use approval in a public hearing for non-compliance with any of the conditions of approval.

14. ENFORCEMENT

After commencement of the approved use, violation of any of the planning conditions of approval contained in the Motion No. _____ or of any other provisions of Planning Code applicable to this project shall be subject to the enforcement procedures and administrative penalties set forth under Planning Code Section 176 or Section 176.1, whichever applicable for each day a violation continues or is allowed to continue. The Planning Department may also refer the violation complaints to other city departments and agencies for appropriate enforcement action under their jurisdiction.

15. MONITORING

If the project requires monitoring of the conditions of approval contained in Exhibit A of Motion No. _____, the project sponsor or the subsequent responsible parties for the project shall

pay fees as established under Planning Code Section 351(e)(1) and work with the Planning Department to ensure compliance.

16. NEIGHBORHOOD CONCERNS

The Project Sponsor shall appoint a Community Liaison Officer to address issues of concern to neighbors related to the operation of this Project. The Project Sponsor shall report the name and telephone number of this Officer to the Zoning Administrator and the neighborhood for reference. The Project Sponsor shall keep the above parties apprised should a different staff liaison be designated.

17. SEVERABILITY

If any clause, sentence, section, or any part of these conditions of approval is for any reason held to be invalid, such invalidity shall not affect or impair other of the remaining provisions, clauses, sentences, or sections of these conditions. It is hereby declared to be the intent of the Planning Commission that these conditions of approval would have been adopted had such invalid sentence, clause, or section or part thereof not been included herein.

Zoning Map

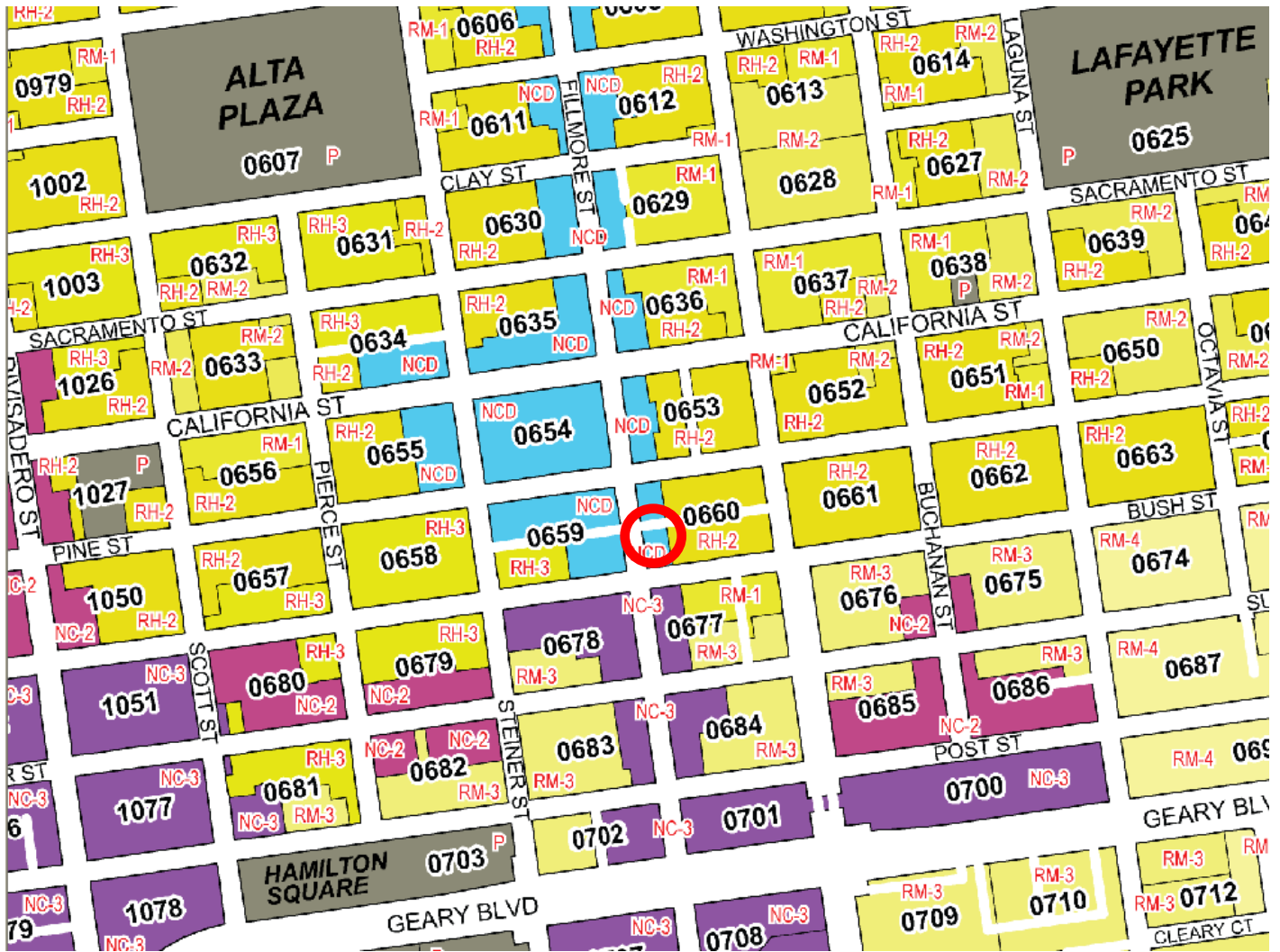

Conditional Use Hearing
Case Number 2009.0251C
1910 Fillmore Street
DBA Fraiche Yogurt Café

Parcel Map

CRS
 DD COMMERCIAL
 NG STUDY
 ISETZ, Dates 1/14/85-3/2/87
 ZM; Ord. 89-87, Date 4/12/87
 Ord. 444-87, Date 12/12/87

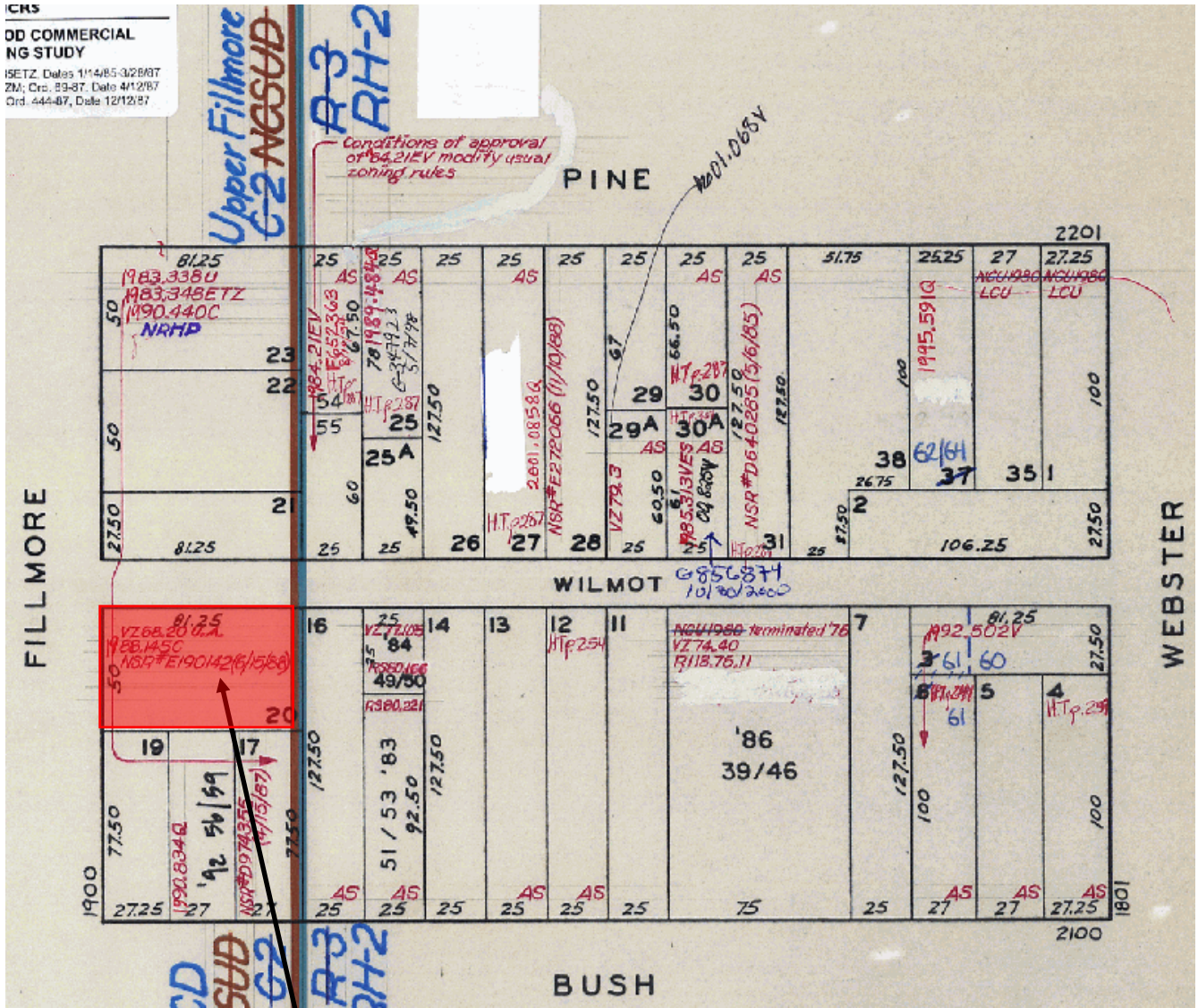

SUBJECT PROPERTY



Conditional Use Hearing
 Case Number 2009.0251C
 1910 Fillmore Street
 DBA Fraiche Yogurt Café

Sanborn Map*

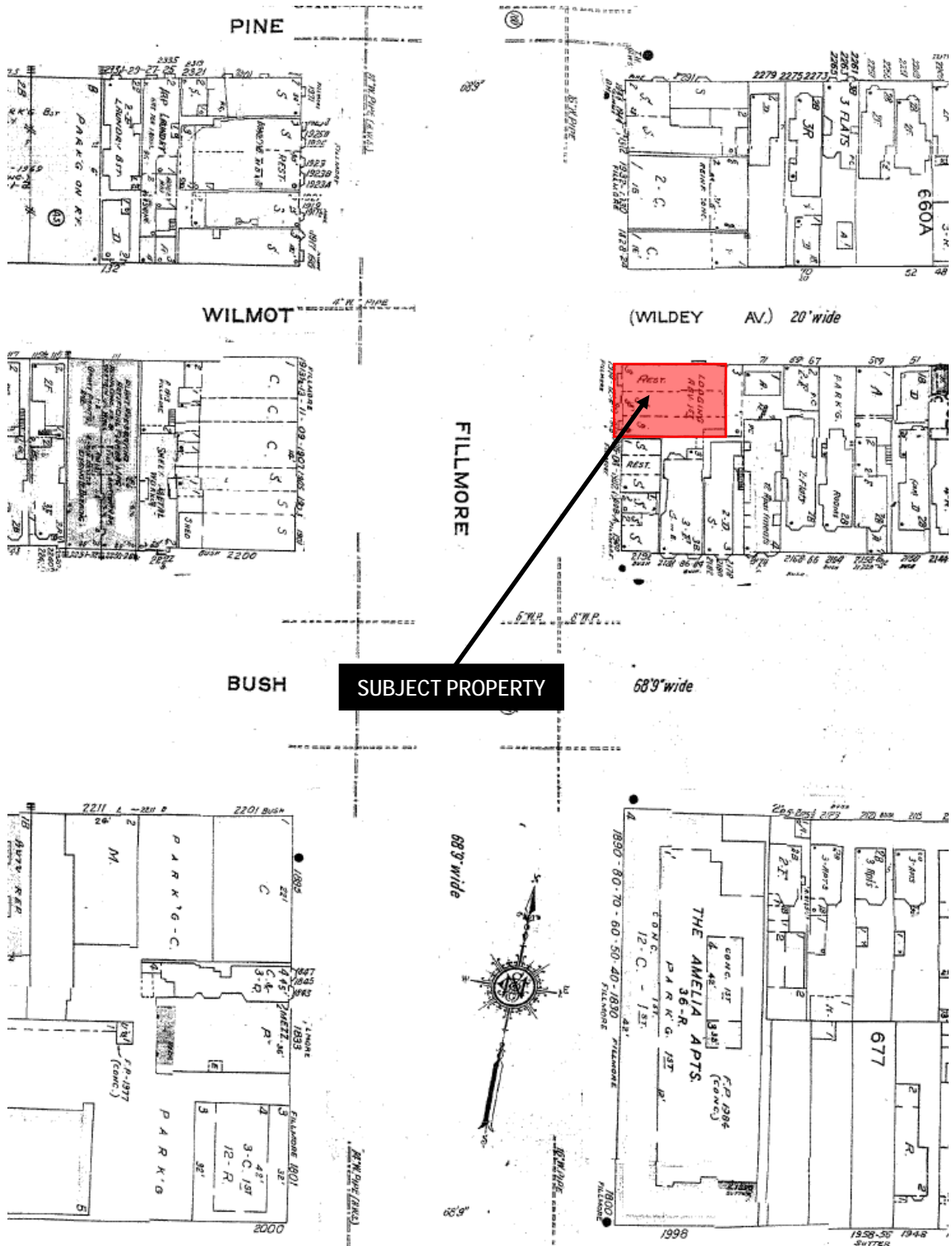

*The Sanborn Maps in San Francisco have not been updated since 1998, and this map may not accurately reflect existing conditions.



Conditional Use Hearing
 Case Number 2009.0251C
 1910 Fillmore Street
 DBA Fraiche Yogurt Café

Aerial Photo*



SUBJECT PROPERTY

**The Aerial Maps reflect existing conditions in March 2009.*



Conditional Use Hearing
Case Number 2009.0251C
1910 Fillmore Street
DBA Fraiche Yogurt Café

Aerial Photo*



SUBJECT PROPERTY

**The Aerial Maps reflect existing conditions in March 2009.*



Site Photo

SUBJECT PROPERTY ON FILLMORE STREET



SUBJECT PROPERTY

Conditional Use Hearing
Case Number 2009.0251C
1910 Fillmore Street
DBA Fraiche Yogurt Café

Site Photo

SUBJECT PROPERTY ON FILLMORE STREET



SUBJECT PROPERTY

Conditional Use Hearing
Case Number 2009.0251C
1910 Fillmore Street
DBA Fraiche Yogurt Café

Site Photo

SUBJECT BLOCK



Conditional Use Hearing
Case Number 2009.0251C
1910 Fillmore Street
DBA Fraiche Yogurt Café

Site Photo

SUBJECT BLOCK



Conditional Use Hearing
Case Number 2009.0251C
1910 Fillmore Street
DBA Fraiche Yogurt Café

Site Photo

OPPOSITE BLOCK



Conditional Use Hearing
Case Number 2009.0251C
1910 Fillmore Street
DBA Fraiche Yogurt Café

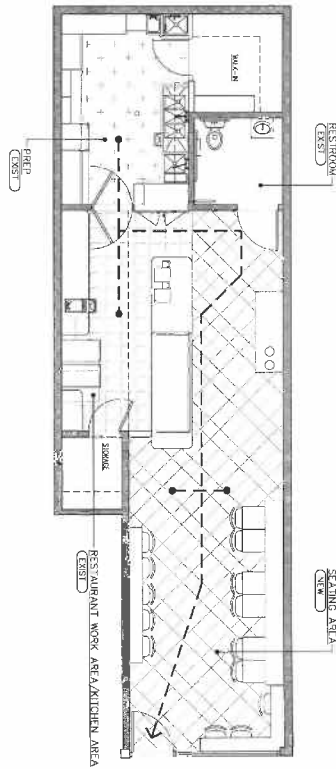

OCCUPANCY LEGEND			
	PREP AREA	OCCUPANCY FACTOR: 200	
	RESTAURANT WORK AREA	OCCUPANCY FACTOR: 200	
	SEATING AREA	OCCUPANCY FACTOR: 15	
	STORAGE	OCCUPANCY FACTOR: 300	
	ACCESSORY USE SPACE	OCCUPANCY FACTOR: NONE	
	→ PATH OF EGRESS		
OCCUPANCY LOADS			
AREA NAME	SQUARE FOOTAGE	OCCUPANT LOAD FACTOR	OCCUPANT LOAD
PREP AREA	190 SF	200	1
SEATING AREA	322 SF	15	77
WORK AREA	91 SF	200	1
RESTROOM	42	N/A	0
	635 SF		79

SHEET
A.004

SHEET DESCRIPTION
GROUND LEVEL
OCCUPANCY PLAN

SCALE
NTS
REF. NORTH



All drawings are to be made according to the standards of the International Building Code and the International Mechanical Code. The contractor shall be responsible for obtaining all necessary permits and for complying with all applicable laws and regulations.

DATE	DESCRIPTION	BY	CHK
08/08/20	ISSUED FOR PERMITS	CHS	CHS
08/08/20	ISSUED FOR PERMITS	CHS	CHS

PROJECT DATA
FRAICHE YOGURT
1810 FILLMORE STREET
SAN FRANCISCO, CA 94114

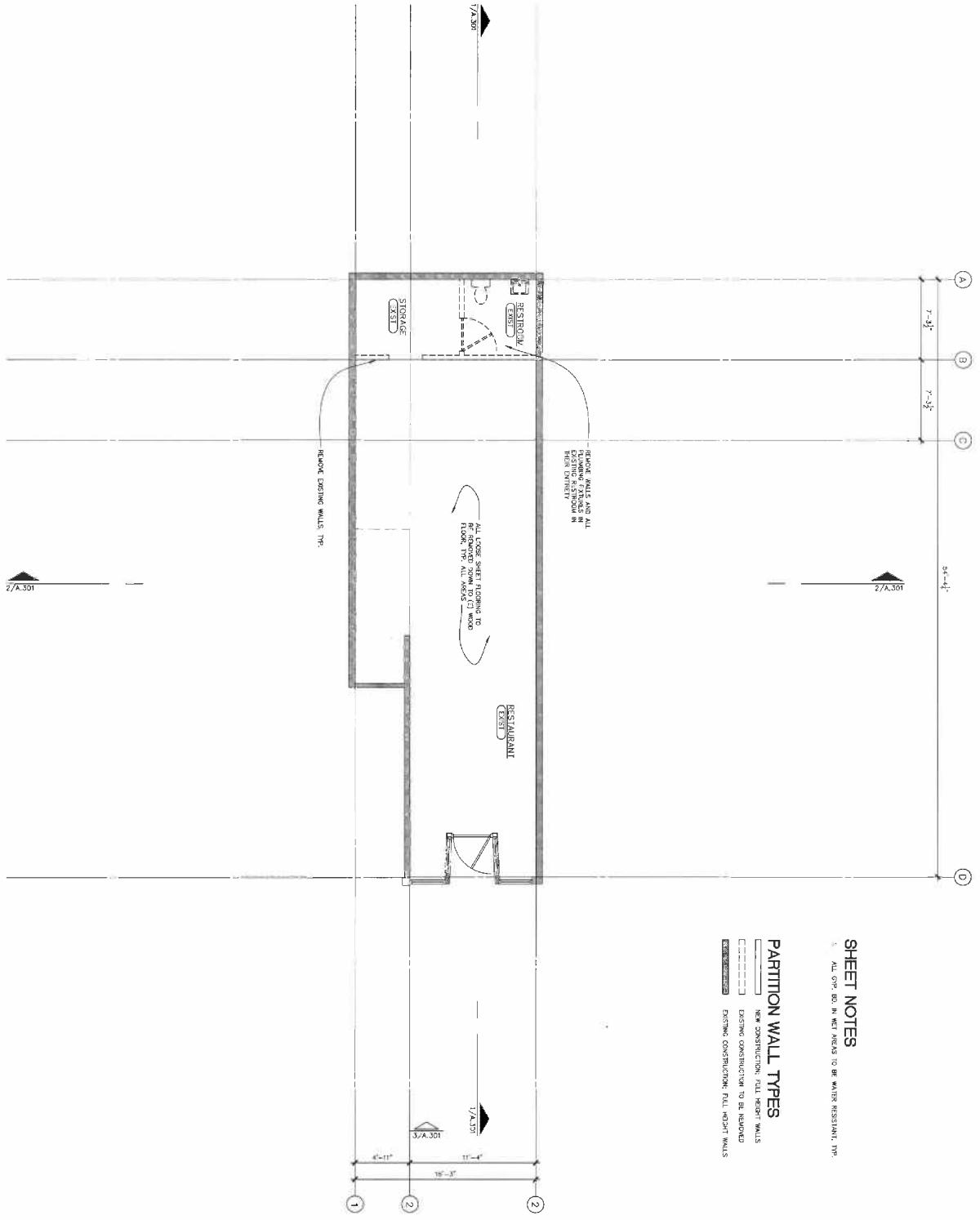

SEVENFOURSEVEN
747 EDDY STREET, #7
SAN FRANCISCO, CA
CA 94109
CHRIS STOKES
TEL. 415 518-4613



SHEET NOTES

1. ALL O.P., D.O. IN NET AREAS TO BE WATER RESISTANT, 1/2\"/>

PARTITION WALL TYPES

-  NEW CONSTRUCTION: FULL HEIGHT WALLS
-  EXISTING CONSTRUCTION: FULL HEIGHT WALLS
-  EXISTING CONSTRUCTION: FULL HEIGHT WALLS

SHEET
A.101
SHEET DESCRIPTION:
GROUND LEVEL DEMO
PLAN

SCALE
1/4"=1'-0"
REF. NORTH



1/4"=1'-0"
1/4"=1'-0"
1/4"=1'-0"

NO.	DATE	REVISION	BY	CHKD.

PROJECT DATA
FRAICHE YOGURT
1310 FILLMORE STREET
SAN FRANCISCO, CA 94114

SEVENFOURSEVEN
747 EDDY STREET, #7
SAN FRANCISCO, CA
CA 94109
CHRIS STOKES
TEL. 415 518-4613

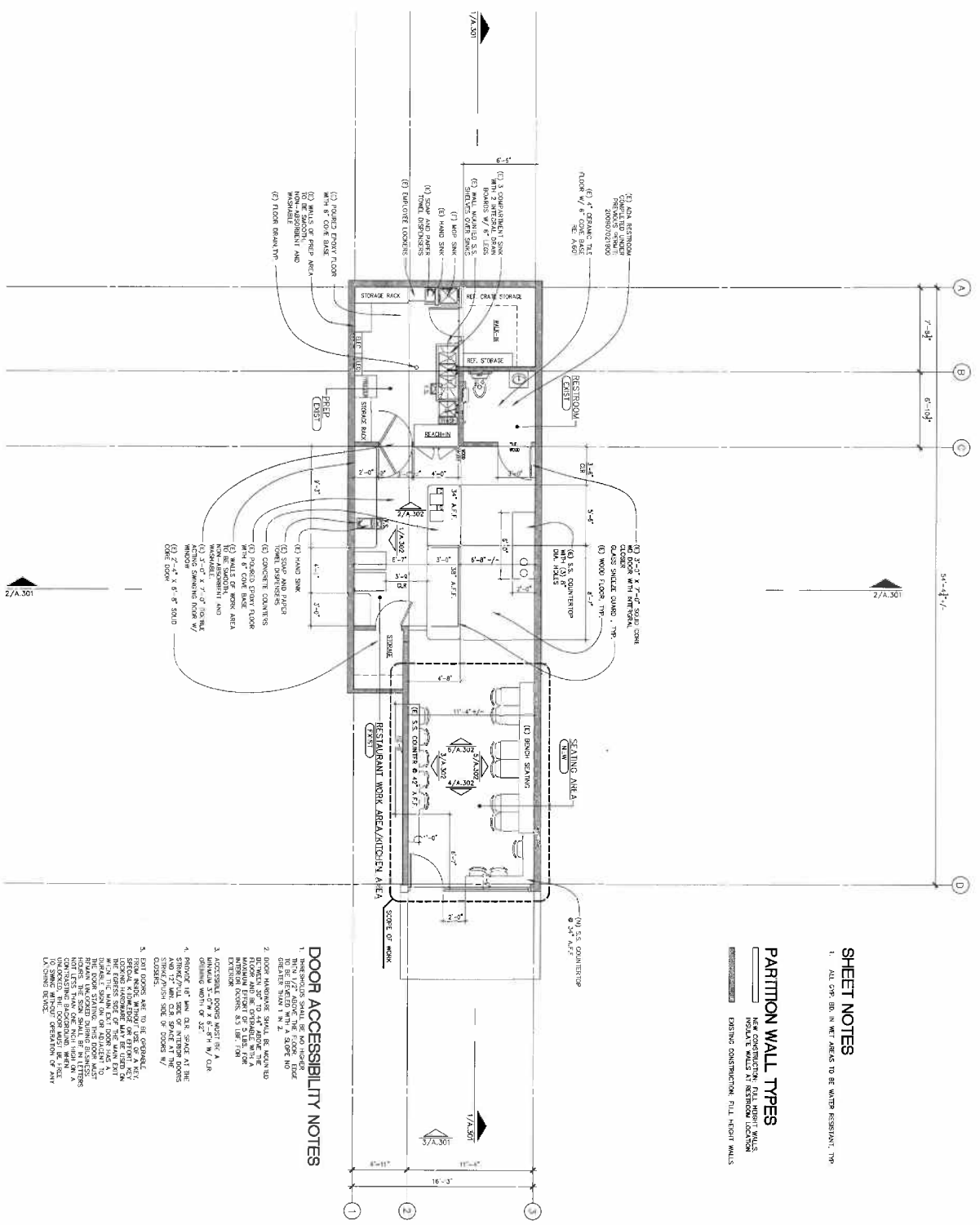

SHEET NOTES

1. ALL OPEN, BAY, OR NET AREAS TO BE WATER RESISTANT. TYP.

PARTITION WALL TYPES

- NEW CONSTRUCTION: FULL HEIGHT WALLS
- EXISTING CONSTRUCTION: FULL HEIGHT WALLS

DOOR ACCESSIBILITY NOTES

1. HESITATIONS SHALL BE NO HIGHER THAN 1/4\"/>
2. DOOR HINGERS SHALL BE LOCATED ON THE INSIDE OF THE DOOR AND SHALL BE TO THE LEFT OF THE DOOR.
3. DOOR HINGERS SHALL BE LOCATED ON THE INSIDE OF THE DOOR AND SHALL BE TO THE LEFT OF THE DOOR.
4. PROVIDE AT LEAST ONE (1) CLEAR SPACE AT THE END OF THE DOOR SWING AT THE CORNER/FISH SIDE OF DOORS W/ EXTERIOR.
5. PROVIDE AT LEAST ONE (1) CLEAR SPACE AT THE END OF THE DOOR SWING AT THE CORNER/FISH SIDE OF DOORS W/ EXTERIOR.
6. PROVIDE AT LEAST ONE (1) CLEAR SPACE AT THE END OF THE DOOR SWING AT THE CORNER/FISH SIDE OF DOORS W/ EXTERIOR.

SHEET **A.201**

GROUND LEVEL FLOOR PLAN

SCALE: 1/4" = 1'-0"



DATE	BY	REVISION

PROJECT DATA
FRAYCHE YOGURT
 1910 FILLMORE STREET
 SAN FRANCISCO, CA 94114

SEVENFOURSEVEN
 747 EDDY STREET, #7
 SAN FRANCISCO, CA 94109
 CHRIS STOKES
 TEL: 415 518-4613

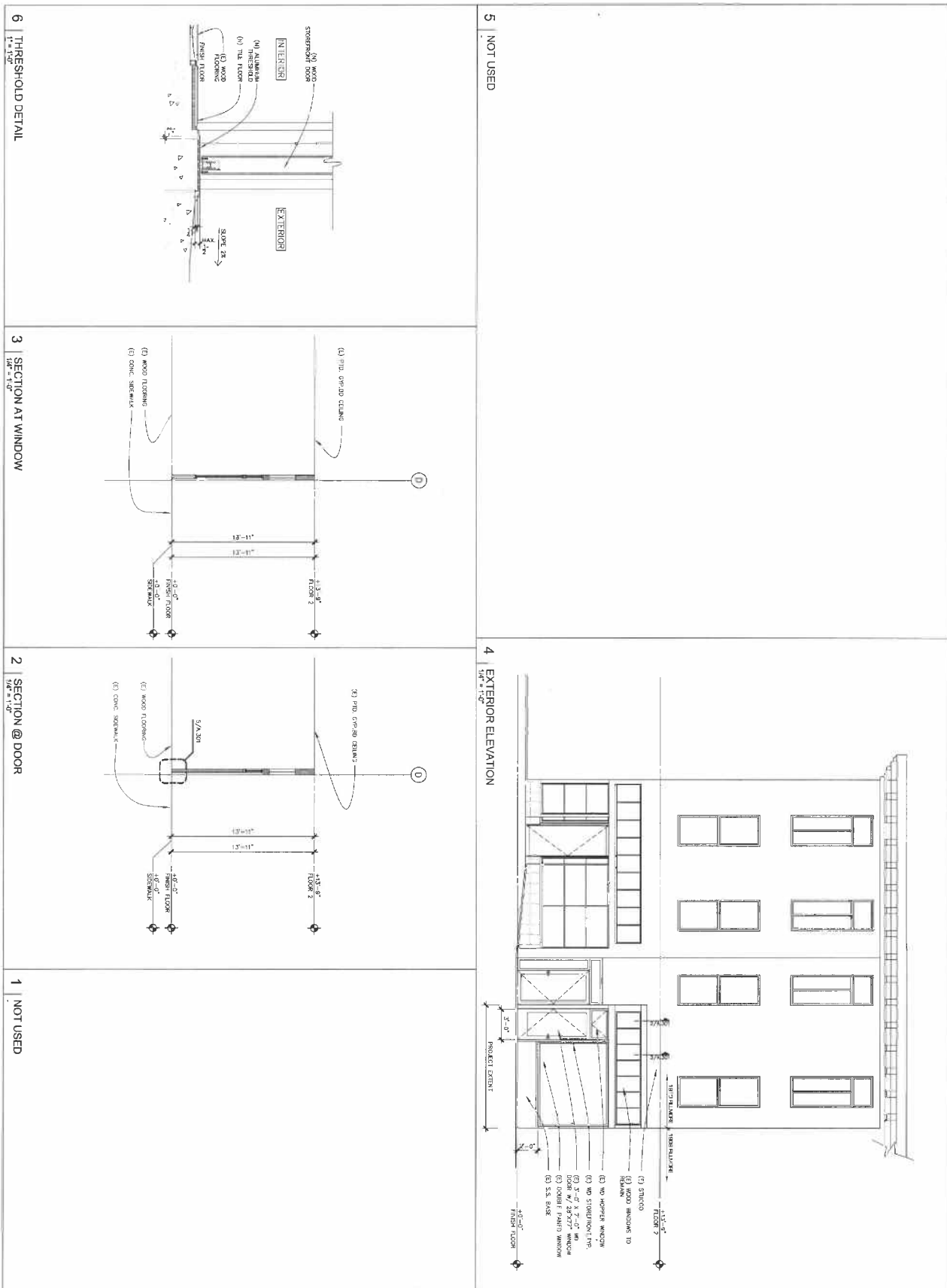

A.301

SCALE: 1/4" = 1'-0"

REVISIONS:

NO.	DATE	DESCRIPTION	BY
01	09/09/09	CHANGE OF USE	CS/AS

PROJECT DATA:

FRACHE YOGURT

1910 FILLMORE STREET
 SAN FRANCISCO, CA 94114

SEVENFOURSEVEN
 747 EDDY STREET, #7
 SAN FRANCISCO, CA 94109
 CHRIS STOKES
 TEL. 415 518-4613

PROJECT DATA:

FRACHE YOGURT

1910 FILLMORE STREET
 SAN FRANCISCO, CA 94114

SEVENFOURSEVEN
 747 EDDY STREET, #7
 SAN FRANCISCO, CA 94109
 CHRIS STOKES
 TEL. 415 518-4613

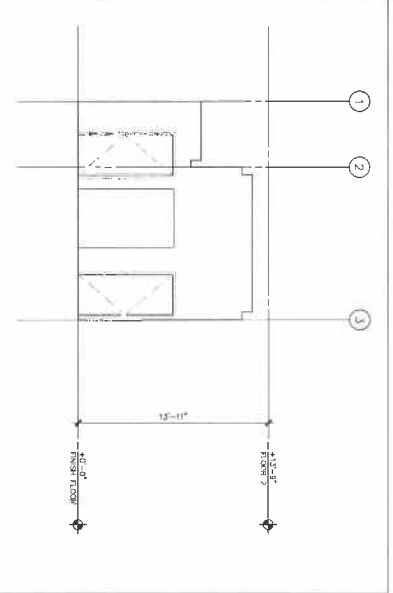

6 INTERIOR ELEVATION
1/4" = 1'-0"

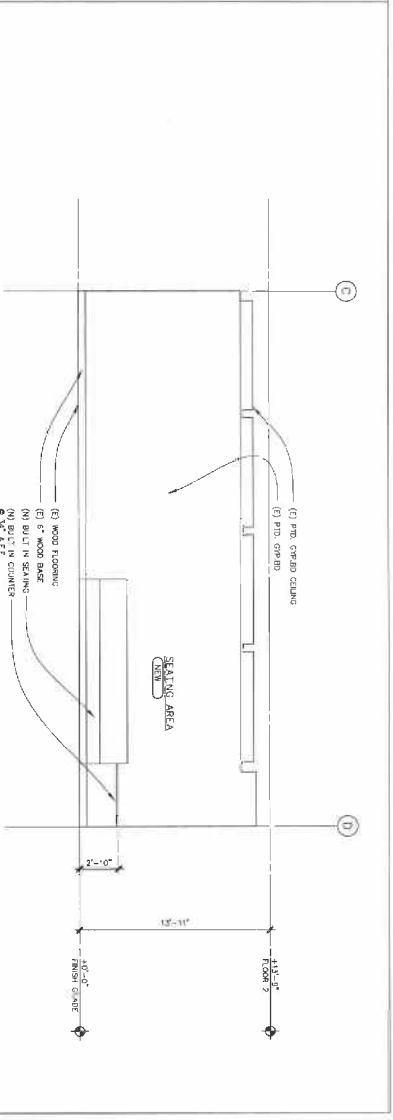

5 INTERIOR ELEVATION
1/4" = 1'-0"

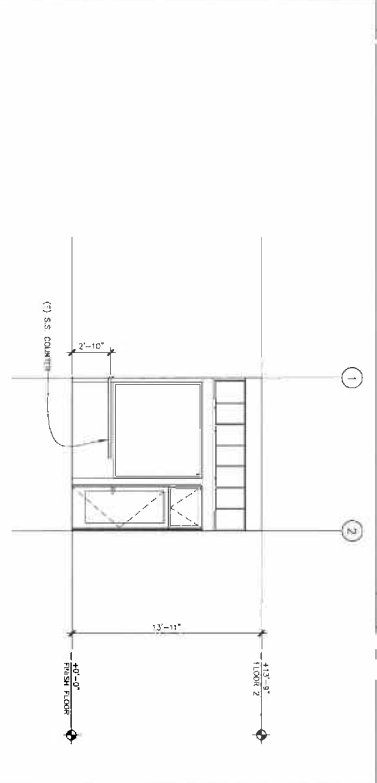

4 INTERIOR ELEVATION
1/4" = 1'-0"

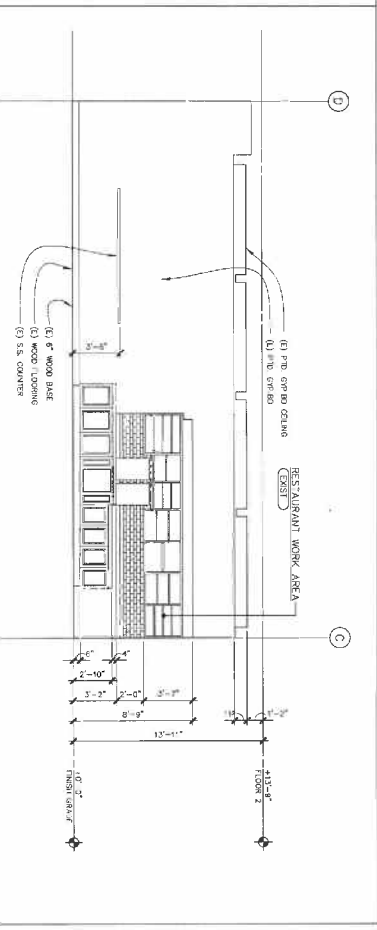

3 INTERIOR ELEVATION
1/4" = 1'-0"

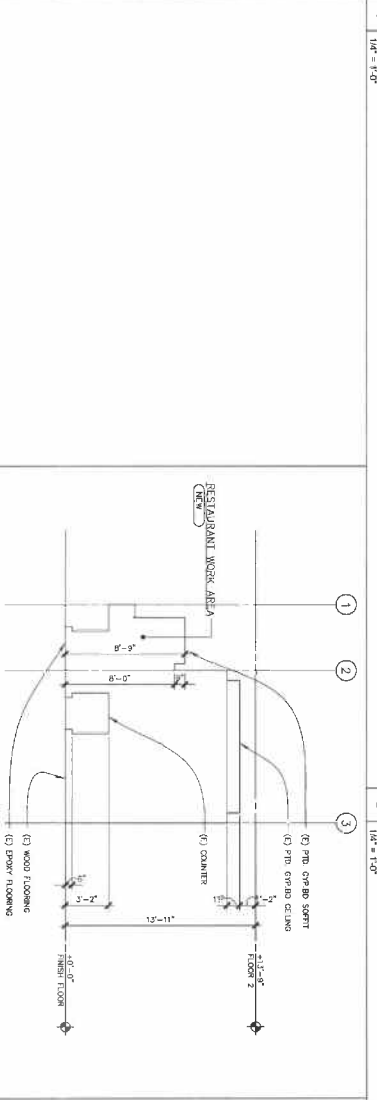

2 INTERIOR ELEVATION
1/4" = 1'-0"

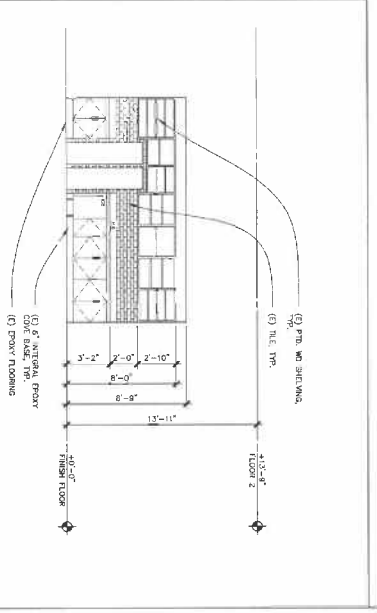

1 INTERIOR ELEVATION
1/4" = 1'-0"

SHEET A.302

SCALE: 1/4" = 1'-0"
REF NORTH

SHEET DESCRIPTION
INTERIOR ELEVATIONS

PROJECT NO.	DATE	BY
PROJECT NAME	DATE	BY
PROJECT ADDRESS	DATE	BY
PROJECT CONTACT	DATE	BY
PROJECT PHONE	DATE	BY
PROJECT FAX	DATE	BY
PROJECT EMAIL	DATE	BY

PROJECT DATA

FRAICHE YOGURT

1910 FILLMORE STREET
SAN FRANCISCO, CA 94114

SEVENFOURSEVEN
747 EDDY STREET, #7
SAN FRANCISCO, CA
CA 94109
CHRIS STOKES
TEL. 415 518-4613

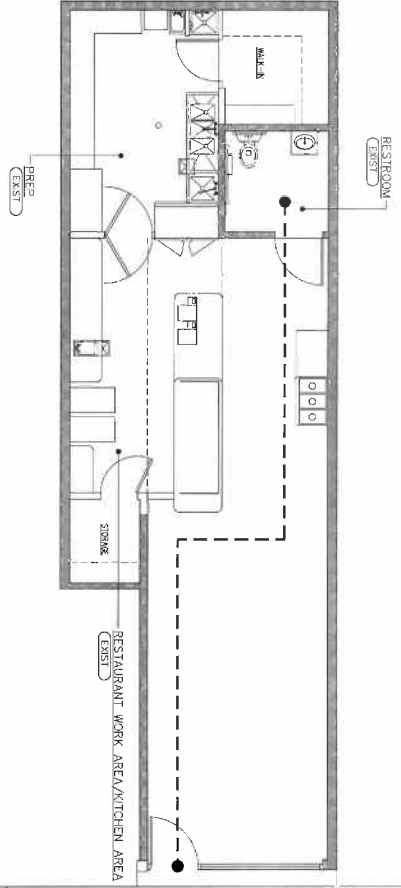

9 ACCESSIBLE ROUTE
N.T.S.

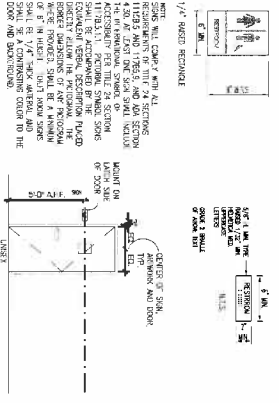

8 RESTROOM S GNAGE
N.T.S.

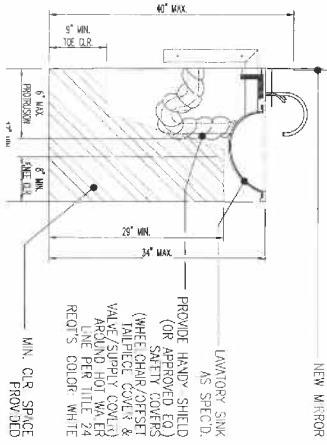

7 NOT USED
N.T.S.

5 LAVATORY SINK
1/4\"/>

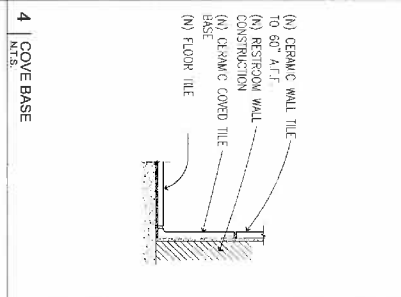

4 COVE BASE
N.T.S.

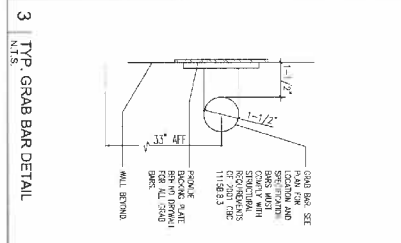

3 TYP GRAB BAR DETAIL
N.T.S.

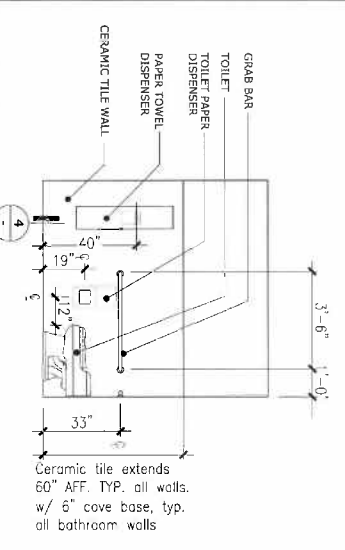

2 RESTROOM ELEVATION
1/4\"/>

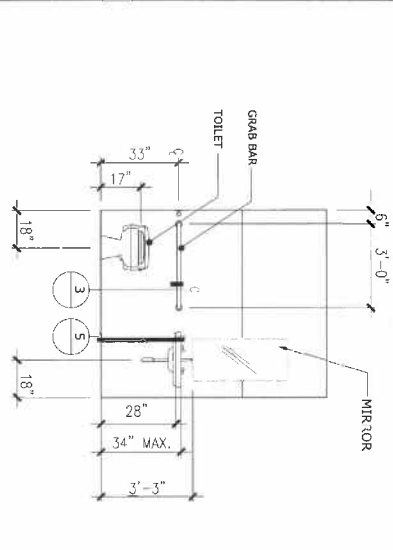

1 RESTROOM ELEVATION
1/4\"/>

SHORT
A.601
 SHEET DESCRIPTION:
 INTERIOR ELEVATIONS
 AND DETAILS
 SCALE:
 AS NOTED
 REF. FOURTH
 ALL DRAWINGS TO BE CHECKED FOR ACCURACY AND COMPLETENESS BY THE ARCHITECT BEFORE PROCEEDING TO THE NEXT PHASE OF THE PROJECT.
 THE ARCHITECT SHALL BE RESPONSIBLE FOR OBTAINING ALL NECESSARY PERMITS AND APPROVALS FROM THE LOCAL AUTHORITIES.
 THE CONTRACTOR SHALL BE RESPONSIBLE FOR OBTAINING ALL NECESSARY PERMITS AND APPROVALS FROM THE LOCAL AUTHORITIES.
 THE CONTRACTOR SHALL BE RESPONSIBLE FOR OBTAINING ALL NECESSARY PERMITS AND APPROVALS FROM THE LOCAL AUTHORITIES.

NO.	DATE	DESCRIPTION	BY	CHK

PROJECT DATA
FRAICHE YOGURT
 1910 FILLMORE STREET
 SAN FRANCISCO, CA 94114

SEVENFOURSEVEN
 747 EDDY STREET, #7
 SAN FRANCISCO, CA
 CA 94109
 CHRIS STOKES
 TEL. 415 518-4613

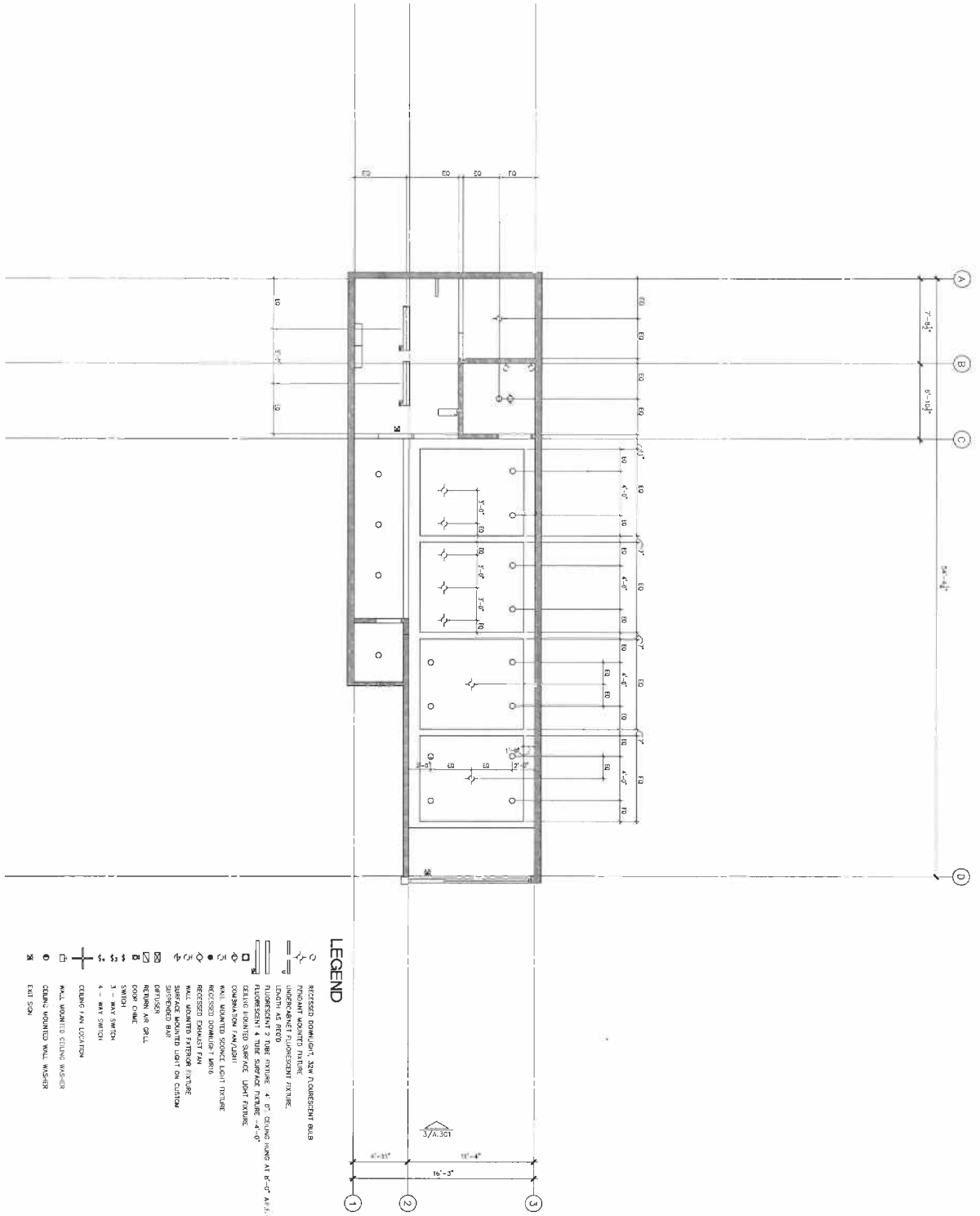

- LEGEND**
- RECESSED DOWNLIGHT, NEW 2-CONDUCTOR BALL
 - PENDANT MOUNTED FIXTURE
 - UNDERCABINET FLUORESCENT FIXTURE
 - FLUORESCENT 2 TUBE FIXTURE, 4 x 8' CEILING HUNG AT 8'-0" A.I.T.
 - LENGTH AS NOTED
 - WALL MOUNTED SCONCE LIGHT FIXTURE
 - WALL MOUNTED 2 PIN SURFACE LIGHT FIXTURE
 - RECESSED DOWNLIGHT, 16" x 16" x 10
 - WALL MOUNTED EXTERIOR FIXTURE
 - SURFACE MOUNTED LIGHT ON CUSTOM SUSPENSION
 - RETURN AIR SHELL
 - DOOR CHIME
 - SWITCH
 - WALL SWITCH
 - CEILING FAN LOCATION
 - WALL MOUNTED CEILING WASHER
 - CEILING MOUNTED WALL WASHER
 - EXIT SIGN

SHEET
A.701
SHEET DESCRIPTION
GROUND LEVEL
REFLECTED CEILING
PLAN

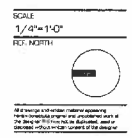

NO. DATE	BY	SCALE AND TYPING	REV. NORTH

PROJECT DATA
FRAICHE YOGURT
1310 FILLMORE STREET
SAN FRANCISCO, CA 94114

SEVENFOURSEVEN
747 EDDY STREET, #7
SAN FRANCISCO, CA
CA 94109
CHRIS STOKES
TEL. 415 518-4613

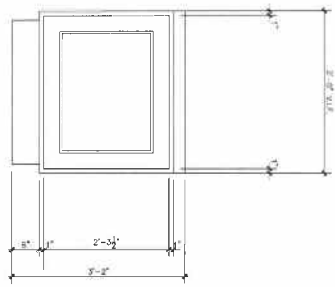

5 | COUNTER SIDE
1/4\"/>

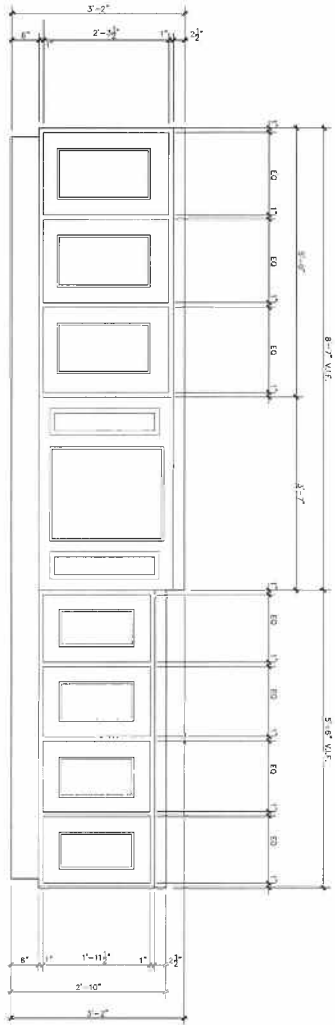

4 | COUNTER FACE
1/4\"/>

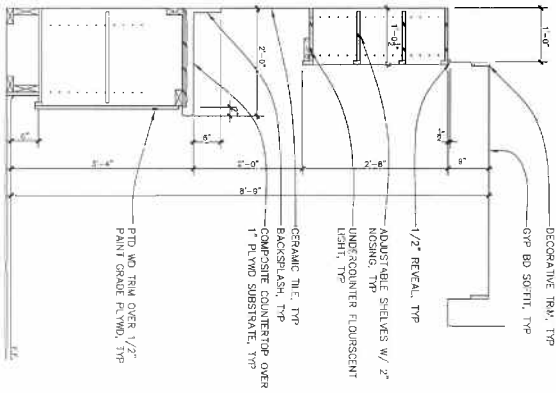

3 | SECTION AT BACK COUNTER
1/4\"/>

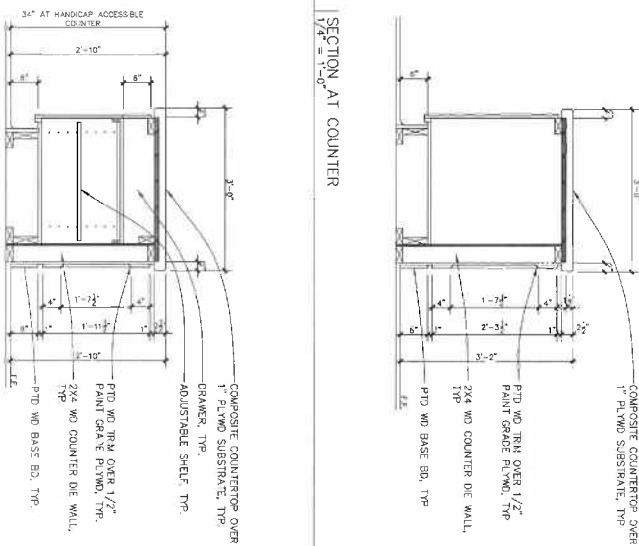

1 | SECTION AT ADA COUNTER
1/4\"/>

SHEET
A.901

SHEET DESCRIPTION
DETAILS

SCALE
1/4\"/>



12. All drawings are for information only. The contractor shall verify all dimensions and conditions on site before construction. The contractor shall be responsible for any errors or omissions on the drawings. The contractor shall be responsible for any changes to the drawings. The contractor shall be responsible for any delays or cost overruns. The contractor shall be responsible for any safety issues. The contractor shall be responsible for any environmental issues. The contractor shall be responsible for any other issues.

NO.	DATE	REVISION/DESCRIPTION	BY/CHK

PROJECT DATA
FRAICHE YOGURT
1810 FILLMORE STREET
SAN FRANCISCO, CA 94114

SEVENFOURSEVEN
747 EDDY STREET, #7
SAN FRANCISCO, CA
CA 94109
CHRIS STOKES
TEL. 415 518-4613

1 GROUND FLOOR REFLECTED CEILING PLAN

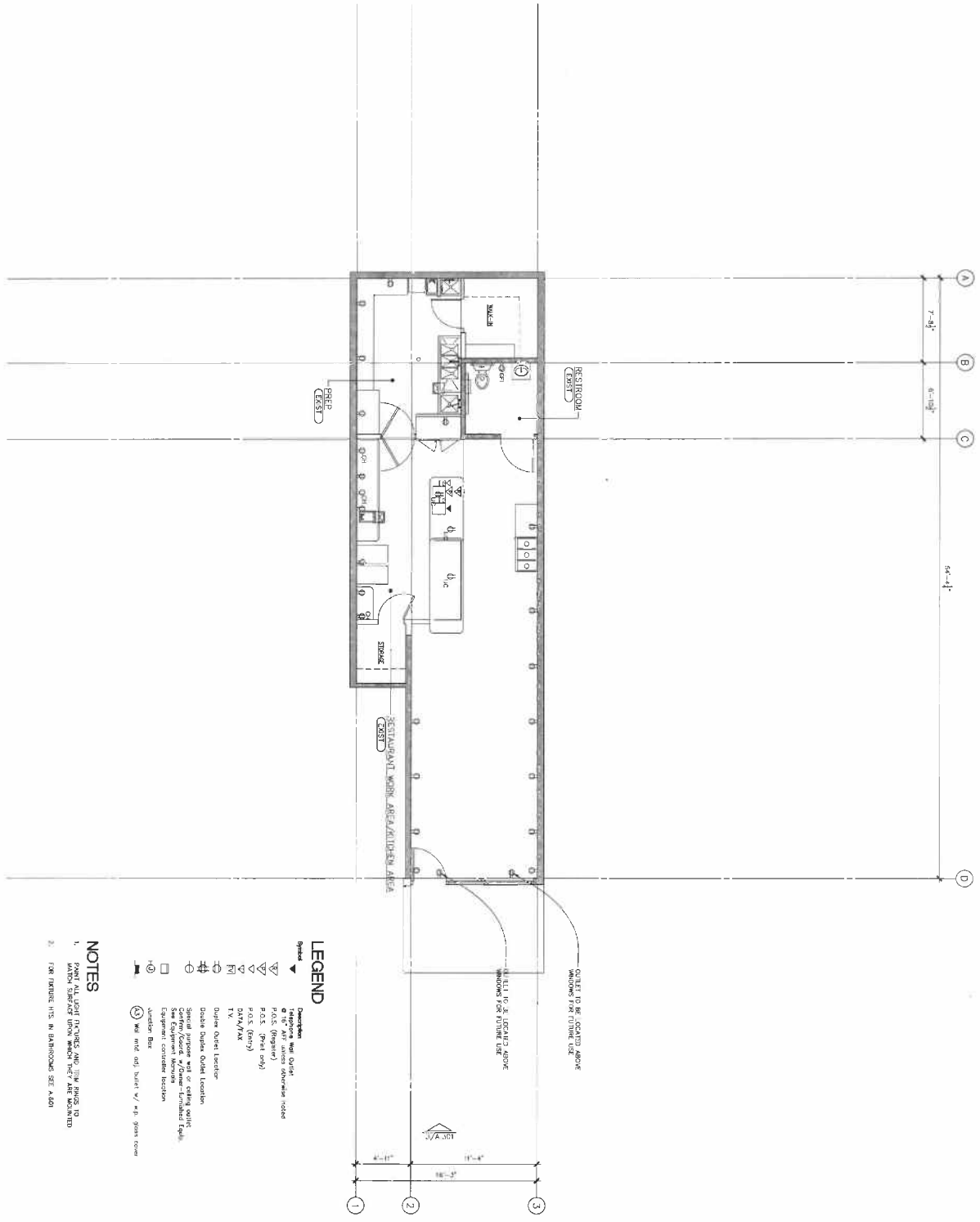

- NOTES**
1. PAINT ALL LIGHT FIXTURES AND TRIM FINISH TO MATCH SURFACE UPON WHICH THEY ARE MOUNTED
 2. FOR FINISHES SEE SCHEDULE

LEGEND

Symbol	Description
	Equipment Note
	F.O.S. (Revised)
	F.O.S. (Final only)
	F.O.S. (Entry)
	D.M./M.A.X.
	Toler. (Detail Location)
	Detail (Detail Location)
	Conf. (Detail Location)
	Equip. (Detail Location)
	Contained location
	Section Box
	Section Box

SHEET **E.201**

GROUND LEVEL
POWER PLAN

SCALE
1/4" = 1'-0"

FOR NOTES

NO.	DATE	REVISION	BY

PROJECT DATA

FRAICHE YOGURT

1910 FILLMORE STREET
SAN FRANCISCO, CA 94114

SEVENFOURSEVEN
747 EDDY STREET, #7
SAN FRANCISCO, CA
CA 94109
CHRIS STOKES
TEL. 415 518-4613

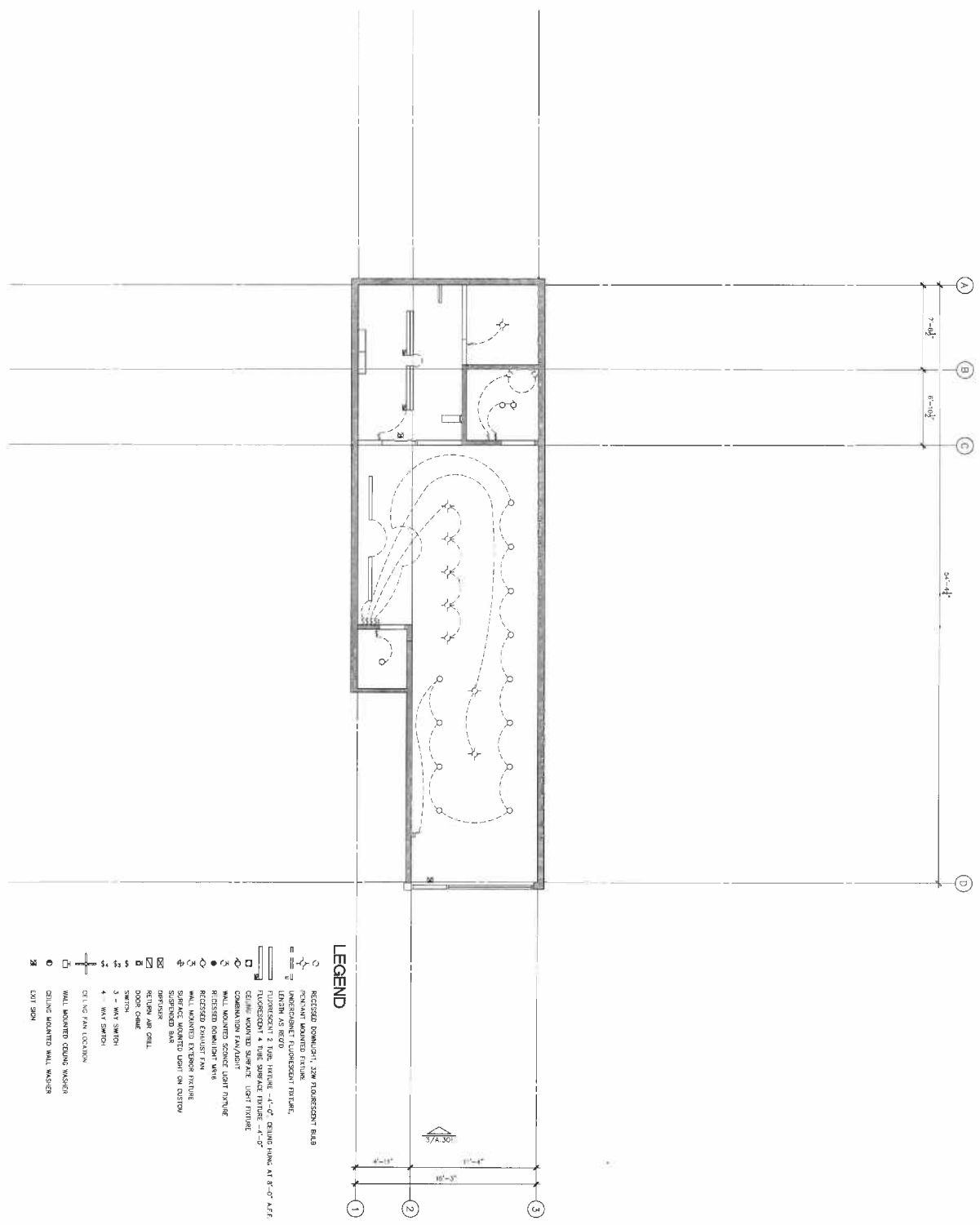

LEGEND

- RECESSED DOWNLIGHT, 20W FRODOSSON™ BALL
- PENANT MOUNTED FEATURE
- UNDERCABINET FLUORESCENT FIXTURE
- LANTERN AS ROOM
- RECESSED 2 LINE, 150W, 4'-0" CEILING PANEL AT 8'-0" A.F.F.
- FLUORESCENT 2 LINE SPACER FIXTURE AT 8'-0"
- COMBINATION PENDANT
- CEILING MOUNTED SPACER LIGHT FIXTURE
- WALL MOUNTED SPACER LIGHT FIXTURE
- RECESSED DOWNLIGHT TRIM
- WALL MOUNTED EXHAUST FAN
- RECESSED EXHAUST FAN
- WALL MOUNTED EXHAUST FAN
- RECESSED EXHAUST FAN
- SUSPENDED BALL
- DIFFUSER
- RETURN AIR GRILL
- DOOR CHAIR
- 3" WAY SWITCH
- 4" WAY SWITCH
- CEILING FAN LOCATION
- WALL MOUNTED CEILING MOUNTED
- CEILING MOUNTED WALL MOUNTED
- EXIT SIGN

SHEET **E.701**

SHEET DESCRIPTION
 SECOND LEVEL
 REFLECTED CEILING
 ELECTRICAL PLAN

SCALE
 3/4" = 1'-0"
 REF. TICKET

NO.	DATE	ISSUES AND REVISIONS	BY/DATE

PROJECT DATA
FRAICHE YOGURT
 1910 FILLMORE STREET
 SAN FRANCISCO, CA 94114

SEVENFOURSEVEN
 747 EDDY STREET, #7
 SAN FRANCISCO, CA
 CA 94109
 CHRIS STOKES
 TEL. 415 518-4613