



SAN FRANCISCO PLANNING DEPARTMENT

MEMO

DATE: January 26, 2011
TO: Architectural Review Committee of the Historic Preservation Commission
FROM: Tim Frye, Acting Preservation Coordinator, (415) 575-6822
RE: **Review and Comment for 706 Mission Street – The Aronson Building Case No. 2008.1084E**

1650 Mission St.
Suite 400
San Francisco,
CA 94103-2479

Reception:
415.558.6378

Fax:
415.558.6409

Planning
Information:
415.558.6377

The Planning Department (Department) and the Project Sponsor (Sponsor) are requesting review and comment before the Architectural Review Committee (ARC) regarding the proposal to construct a 550-foot-tall (520-feet to the roof with a 30-foot mechanical penthouse) mixed-use structure adjoining the Aronson Building. The proposed project would include the removal of two non-historic additions, the rehabilitation and restoration of the Aronson Building, a new 47-story, 550-foot-tall tower containing up to 215 residential units, space for the Mexican Museum, a retail/restaurant use, and associated building services.

BACKGROUND

The project is currently undergoing environmental review per the California Environmental Quality Act (CEQA) by the Department (Case No. 2008.1048E). The Aronson Building was evaluated as part of the adopted Transit Center Survey and identified as individually eligible to the National Register and eligible as a contributor to a California Register eligible district.

PROPERTY DESCRIPTION

The site is located at northwest corner of Third and Mission Streets (Assessor's Block 3706, Lot 093, 275, and portions of 277), is within the former Yerba Buena Redevelopment Area and is adjacent to Jessie Square, the Contemporary Jewish Museum, and St. Patrick's Church. The site is zoned Downtown Retail (C-3-R) District and is located in a 400-I Height and Bulk District.

PROJECT DESCRIPTION

The proposed project is to construct a 550-foot-tall (520-feet to the roof with a 30-foot mechanical penthouse) mixed-use structure adjoining the Aronson Building. The proposed project would include the removal of two non-historic additions, the rehabilitation and restoration of the Aronson Building, a new 47-story, 550-foot-tall tower containing up to 215 residential units, space for the Mexican Museum, a retail/restaurant use, and associated building services. There would be 44 floors of residential space (with mechanical areas) and three floors of museum space. The museum would share the ground floor with the residential lobby and the retail/restaurant space. Building services would occupy a small portion of each floor, both above and below grade.

STAFF ANALYSIS

There are several components of the proposed project that the Department seeks the advice of the ARC regarding compatibility with the Secretary of the Interior's Standards. The Department would like the ARC to consider the following information:

Exterior Rehabilitation:

The Sponsor has indicated that the exterior of the subject building will be rehabilitated in accordance with the Secretary of the Interior's Standards. Page & Turnbull has prepared a historic structure report in order to fully document the Aronson Building and provide useful guidance for treatment. The HSR was developed at the request of the Department for the use of the Sponsor, as well as private contractors hired to perform any restoration, rehabilitation, preservation, and/or maintenance work.

The report outlines the following recommendations:

- Preserve the historic character of the Aronson Building and investigate means to stabilize the character-defining fabric at the facades from further deterioration.
- Rehabilitate the primary facades through the repair of the terra cotta, terra cotta brick, Colusa sandstone, and ironwork.
- Protect interior historic fabric noted as significant or contributing, such as the wood casework at the existing windows, to the extent possible.
- Adjacent new construction should be constructed in a way that the original massing and form of the Aronson Building will still be conveyed.
- Adjacent new construction should be constructed in a way that will avoid, to the extent possible, the removal of character-defining historic features.
- Windows should be replaced with new that are similar to the historic windows in style and operation.
- Non-historic brick infill and storefronts at the lower level should be replaced with storefronts similar to the historic storefronts in style.
- Additions and mechanical equipment at the rooftop should not visually dominate views of the building from the public right of way across the street.
- The building should be assessed by a structural, mechanical, electrical, and plumbing engineer. The existing mechanical, electrical and plumbing systems are not original to the

building. Replacement mechanical, electrical, and plumbing systems should be installed to minimize impact to historic fabric to the extent possible.

Recommendation:

1. The Department concurs with the recommendations outlined within the Page & Turnbull HSR; however, the Department seeks the advice of the ARC regarding several items of the exterior rehabilitation. Those items are discussed in detail below.

Storefront Systems:

The base of the Aronson Building includes the first through third stories along Mission and Third Streets. There are two historic entries to the subject building, one on Mission Street and one on Third Street. A modern bulkhead clad in dark vertical tile runs the length of the building, and the bays are divided by cast iron Ionic pilasters (one features a small plaque on the plinth, which notes "Vulcan Iron Works San Francisco"). The capitals of the Ionic pilasters on the ground floor are missing along the Third Street elevation. The ground floor storefront openings have been filled in and clad in non-historic buff colored brick tile veneer.

The proposal is to install contemporary storefront systems that are based on the general proportions of the historic storefront systems as depicted in photographs from the subject building's period of significance. The Department's Storefront Standards, which have also been adopted by the HPC, recommend that where a historic storefront is missing, and no evidence of its character exists, a simplified interpretation in terms of overall proportion and configuration may be appropriate.

Provided that an emphasis is placed upon matching the character and proportion of the historic storefront systems, the Department believes that a simplified contemporary interpretation in substitute materials is appropriate, and is consistent with the Department's interpretation of the Secretary of the Interior Standards.

The Department has met with the Sponsor to discuss various options for suitable replacement storefront systems for the Aronson Building. While the proposal has improved, the Department still has concerns regarding the overall form, proportion, and character as it relates to the subject building. The Department does not believe that the proposed storefront systems are in conformance with Standard No. 9 because they diverge too far from the proportions and character of the historic storefront systems. The Department believes that the replacement storefront systems should take stronger cues from storefront systems illustrated in the historic photograph of the subject building.

Recommendation:

1. The 1906 photo indicates that the ground-floor storefronts were constructed at a pedestrian scale with very tall, possibly stacked, transoms located above. The proposed contemporary storefront systems introduce a horizontal member that separates the transom area from the main storefront glazing that is not in the same location as depicted

in the 1906 historic photograph. It appears that the horizontal element should be lowered and the height of the transom increased.

2. The proposed painted metal panel that frames each storefront opening is very simple in design. The Department is concerned about the manner in which the metal panel alters the overall historic storefront opening, and when joined with the other components of the storefront system, appears monolithic in character and disconnected to the surrounding historic features of the building. The metal panel surround should be eliminated from the storefront system and the frame should be pulled to the edges of the opening to maximize glazing and reflect the proportions of a typical historic storefront system from the period of significance.

New Openings on North Elevation:

The north elevation of the subject building is a secondary elevation. It is clad in red common brick, and other than the cladding, it does not possess any significant architectural character-defining features. The proposal includes the introduction of a number of punched openings along this elevation. It's the Department's understanding that the pattern and size of the openings are meant to reflect and reference the typical conditions encountered on secondary elevations of the subject building and other historic buildings of the same period and type. According to the Page & Turnbull letter provided in your packet, the openings will be setback three to five feet from the northeast corner of the building (Third Street façade). It's important to note that a common practice based on interpretation of the Standards would be to require that the proposed punched openings begin further back from the northeast corner in order to retain more historic fabric and to maintain view sheds of the historic conditions of the subject building. In reviewing the proposal, the Department believes that this setback would be equivalent to eliminating the first row of windows along the party wall that are closest to Third Street.

Recommendation:

1. The Department believes that the punched openings proposed along the north elevation are appropriate as proposed and meet the Secretary of the Interior's Standards. The openings are located on a secondary elevation and will not result in the removal of any significant character-defining features of the building; the punched openings are proposed to be set back from the Third Street elevation in order to convey a sense of the historic conditions of the subject building; while contemporary in pattern, design, and framing, the openings reference the character and pattern of punched openings found on other historic buildings of the same period and building type.

New Entry on North Elevation:

The north elevation of the subject building is a secondary elevation. It is clad in red common brick, and other than the cladding, it does not possess any significant architectural character-defining features. A new entry and canopy is proposed for the north elevation of the building.

Several courses of bricks will be removed to allow for the insertion of a simple painted metal design element. This element will abut the historic Colusa sandstone façade along Third Street.

Recommendation:

1. The Department believes that the proposed entry and canopy are consistent with the Secretary of the Interior’s Standards. Both elements will be setback from the Third Street elevation in order to preserve historic fabric, allow the building to convey a sense of its historic condition, and to minimize its visual impact on the overall character-defining features of the subject building. The Department believes that the introduction of the painted metal design element is subordinate in nature to the overall design, form, and character of the subject building and also meets the Secretary of the Interior’s Standards.

Massing and Setbacks:

The proposed tower will be constructed adjacent to and will connect to the subject building along the west elevation, a secondary elevation that has been heavily modified through alterations and the construction of an addition in the 1970s. According to the information provided by the Sponsor, the proposal will not constitute a demolition of the subject building as identified in Article 10 of the Planning Code. The tower will reintroduce a setback at Mission Street to allow the building to convey its historic massing and form. A portion of the east elevation of the tower will project over the subject building beginning at the 15th-floor, approximately 2 floors above the parapet of the subject building.

Recommendation:

2. The Department believes that the overall siting, massing, setbacks, and form of the proposed tower are sympathetic to the adjacent subject building and are consistent the Secretary of the Interior’s Standards. The subject building will continue to express its historic form and massing and will be perceived as a separate structure.

Access Variant 2A:

The Department is evaluating several variants to the proposed project. The variants are related to vehicular access. Of the variants to be evaluated the Department is concerned with the potential significant impact that could result from Variant 2A. More information is required to fully evaluate this variant; however, the Department seeks the input of the ARC regarding all variants and their potential for impacts to historic resources.

Recommendation:

1. Initial review of Variant 2A indicates to the Department that the removal of the north wall at the ground floor level and the introduction of a vehicular drop off area within the footprint of the subject building would result in an adverse impact upon the historic resource. Variant 2A would require significant exterior and interior alterations to the historic form of the building. Based on the information provided by the Sponsor as of the

date of this report, the Department believes that the overall area of the exterior north wall to be removed in order to accommodate vehicular traffic, in addition to the potential structural modifications and the alterations to the historic entrance of the building on Third Street to provide a Code-complying egress stair, would result in an adverse material and visual impairment to the historic resource.

REQUESTED ACTION

Specifically, the Department seeks comments on:

- The compatibility of project with the Secretary of the Interior Standards, including the massing and setbacks of the tower and its relationship to the Aronson Building.
- The project concerns raised by staff; and,
- The project recommendations proposed by staff.

ATTACHMENTS

- Project Sponsor architectural plans, elevations, and renderings, December 7, 2010.
- Letter from Page & Turnbull dated January 24, 2011
- CD that contains Page & Turnbull Historic Structures Report dated December 2, 2010

THE ARONSON BUILDING
SAN FRANCISCO, CALIFORNIA

HISTORIC STRUCTURE REPORT
FINAL DRAFT [08197]



PAGE & TURNBULL

imagining change in historic environments through design, research, and technology

DECEMBER 2, 2010

TABLE OF CONTENTS

TABLE OF CONTENTS	0
INTRODUCTION	1
STUDY SUMMARY	1
Purpose	2
Recommendations for Treatment and Use	2
PROJECT DATA	3
Location	3
Project Information	3
Current Historic Status	3
Methodology	7
Client Team	7
PART I. DEVELOPMENTAL HISTORY	8
A. HISTORICAL BACKGROUND AND CONTEXT	8
Early San Francisco History	8
South of Market Neighborhood, Northeast	8
The Aronson Building	13
Owners and Occupants	23
Developer and Architect	25
Materials Providers	27
B. CHRONOLOGY OF DEVELOPMENT AND USE	29
C. PHYSICAL DESCRIPTION	32
Architectural Description	32
Character-Defining Features	39
D. EVALUATION OF SIGNIFICANCE	41
National Register of Historic Places	41
California Register of Historical Resources	41
Period of Significance	43
E. SIGNIFICANCE DIAGRAMS	44
Summary	45
F. CONDITIONS ASSESSMENT	52
Conditions Assessment Methodology	52
Conditions Definitions	52
Summary of Existing Conditions	53
Conditions Assessment of Features	54

PART 2. TREATMENT AND WORK RECOMMENDATIONS.....	65
A. HISTORIC PRESERVATION OBJECTIVES.....	65
B. REQUIREMENTS FOR WORK.....	66
Laws, Regulations & Functional Requirements.....	66
C. WORK RECOMMENDATIONS AND ALTERNATIVES.....	67
Secretary of the Interior's Standards for the Treatment of Historic Properties.....	67
General Recommendations.....	68
General Treatment for Common Materials.....	73
REFERENCES.....	79
PUBLISHED.....	79
PUBLIC RECORDS.....	79
NEWSPAPERS AND PERIODICALS.....	80
INTERNET SOURCES.....	80
OTHER.....	80
APPENDICES.....	81

INTRODUCTION

This Historic Structure Report (HSR) is for use by 706 Mission Street Co., LLC for guidance on future maintenance and projects. The report documents the history and development of the Aronson Building (700-706 Mission Street, APN 3706-093) and provides an assessment of its existing condition, identifies its character-defining features, and describes appropriate approaches to the treatment and rehabilitation of the property that reflect its historic significance. This HSR also outlines a scope of recommended work consistent with a rehabilitation approach.

STUDY SUMMARY

Constructed in 1903 by Abraham Aronson, the project's real estate developer, the Aronson Building featured a steel and concrete structure. It was designed in the Chicago School style by the San Francisco architecture firm of Hemenway & Miller. Located at the corner of Mission and 3rd streets, the building stands 10 stories tall with primary facades featuring terra cotta detailing, cast iron storefronts and Colusa sandstone. Having survived both the 1906 earthquake and fire and the 1989 Loma Prieta earthquake, the building stands today looking much as it did in 1906 with the exception of modern additions to the northwest and southwest and an alteration consisting of brick infill of the storefronts at the ground level.

Although not listed on the National Register of Historic Places, the Aronson Building has been previously determined individually eligible for listing in both the National Register of Historic Places and the California Register under Criterion C/3 (Design/Construction). It is significant for its design which is recognized as the most representative and elaborate design in the Chicago School style. The Aronson Building has also been determined to be a contributing resource of the Aronson Historic District, which is listed in the California Register under Criterion C/3. The Aronson Historic District originally included two other buildings, the Williams Building and the Rosenthal/Grace Building; however, the Rosenthal/Grace Building has since been demolished.

Though the Aronson Building has undergone alterations and additions, it retains sufficient integrity to convey its historic significance in terms of location, setting, design, materials, workmanship, feeling, and association. Exterior alterations have been mostly additive in nature and have not removed significant historic fabric. The building still conveys its historic significance as a Chicago School commercial building, as well as a survivor of the 1906 Earthquake and Fire.

Page & Turnbull has determined the period of significance for the Aronson Building to be 1903-1907, the same period as the Aronson Historic District. The period encompasses the time the building was constructed as well as the time it was rehabilitated after the 1906 Earthquake and Fire.

In anticipation of new development adjacent to the Aronson Building, this HSR has been prepared to act as both a record of the building's history and guide to rehabilitation. The purpose of this study is to understand the historic significance of the Aronson Building and recommend appropriate rehabilitation options for retaining the property's historic character while accommodating future use and potential development. Although this HSR makes note of the Aronson Historic District, the focus of this HSR is on the individual Aronson Building and not on the building as a contributor to a historic district.

Purpose

It is essential that an HSR be prepared in advance of any anticipated rehabilitation, restoration or major maintenance work on a building that has been identified as a historic resource. This HSR is based on the National Park Service publication: *Preservation Brief 43: The Preparation and Use of Historic Structure Reports*. According to *Preservation Brief 43*:

“The historic structure report is an optimal first phase of historic preservation efforts for a significant building, preceding design and implementation of its preservation, rehabilitation, restoration, or reconstruction. If work proceeds without a historic structure report as a guide, physical evidence important to understanding the history and construction of the building may be destroyed. The preparation of a report prior to initiation of work provides documentation for future researchers. Even more importantly, prior preparation of a report helps ensure that the history, significance, and condition of the property are thoroughly understood and taken into consideration in the selection of an appropriate treatment and in the development of work recommendations. A well prepared historic structure report is an invaluable preservation guide.”

The purpose, therefore, of this HSR is to fully document the Aronson Building and provide useful guidance for treatment. This HSR is principally for the use of 706 Mission Street Co., LLC, as well as private contractors hired to perform any restoration, rehabilitation, preservation, and/or maintenance work.

Recommendations for Treatment and Use

Page & Turnbull recommends the adoption of the Rehabilitation treatment option. Taken as a whole, this strategy is superior to the other options, because it retains the character-defining features of the building, while simultaneously allowing for alterations or additions that serve the building's current and future use.

The condition of the Aronson Building is marked by age and resulting impacts from seismic activity, including the 1906 earthquake and fire and the 1989 Loma Prieta earthquake. Generally the building is in fair condition. The building has undergone several interior renovations, resulting in removal of most interior finishes and historic fabric. Although the character-defining features at the exterior of the building still remain, the exterior cladding is in fair to poor condition with cracked and spalled terra cotta and sandstone.

General recommendations to guide the Aronson Building rehabilitation design approach include:

- Preserve the historic character of the Aronson Building and investigate means to stabilize the character-defining fabric at the facades from further deterioration.
- Rehabilitate the primary facades through the repair of the terra cotta, terra cotta brick, Colusa sandstone, and ironwork.
- Protect interior historic fabric noted as significant or contributing, such as the wood casework at the existing windows, to the extent possible.
- Adjacent new construction should be constructed in a way that the original massing and form of the Aronson Building will still be conveyed.
- Adjacent new construction should be constructed in a way that will avoid, to the extent possible, the removal of character-defining historic features
- Windows should be replaced with new that are similar to the historic windows in style and operation.

- Non-historic brick infill and storefronts at the lower level should be replaced with storefronts similar to the historic storefronts in style.
- Additions and mechanical equipment at the rooftop should not visually dominate views of the building from the public right of way across the street.
- The building should be assessed by a structural, mechanical, electrical, and plumbing engineer. The existing mechanical, electrical and plumbing systems are not original to the building. Replacement mechanical, electrical, and plumbing systems should be installed to minimize impact to historic fabric to the extent possible.

PROJECT DATA

This HSR was prepared for 706 Mission Street Co., LLC as a planning tool for future work related to the Aronson Building.

Location

The Aronson Building is located at the northwest corner of Mission Street and 3rd Street. The building sits approximately ten feet back from the street curb, with loading access at the northwest facade. The current main entrance to the building is located at the southwest addition façade.

Project Information

The client group, 706 Mission Street Co., LLC, is investigating appropriate reuse and rehabilitation strategies for the Aronson Building as it relates to future development of the adjacent site to the southwest. This HSR provides the historical and architectural background necessary for rehabilitation planning.

Current Historic Status

This section examines the national, state, and local historical ratings currently assigned to the Aronson Building.

California Historical Resource Status Code

Properties listed or under review by the State of California Office of Historic Preservation are assigned a California Historical Resource Status Code (Status Code) of “1” to “7” to establish their historical significance in relation to the California Register of Historical Resources (California Register or CR) or the National Register of Historic Places (National Register or NR). Properties with a Status Code of “1” or “2” are either eligible for listing in the National Register or the California Register, or are already listed in one or both of the registers. Properties assigned Status Codes of “3” or “4” appear to be eligible for listing in either register, but normally require more research to support this rating. Properties assigned a Status Code of “5” have typically been determined to be locally significant or to have contextual importance. Properties with a Status Code of “6” are not eligible for listing in either register. Finally, a Status Code of “7” means that the resource has not been evaluated for the National Register or the California Register, or needs reevaluation.

The Aronson Building is listed in the California Historical Resources Information System (CHRIS) database, which means that the resource has been formally evaluated by the State of California Office of Historic Preservation for listing in the National Register or California Register. It is listed as a “2S” (“Individual property determined eligible for NR by the Keeper. Listed in the CR”) and a “2D” (“Contributor to a district determined eligible for NR by the Keeper. Listed in the CR”). The building was evaluated for its “2S” designation during a project review in October 1977 and a historic survey in January 1979. The building was evaluated for its “2D” designation in January 1979 (see Historic Districts below).

Previous Surveys and Designations

San Francisco Architectural Heritage Downtown Survey

San Francisco Architectural Heritage is the city's oldest not-for-profit organization dedicated to increasing awareness and advocating preservation of San Francisco's unique architectural heritage. Heritage has sponsored several historic resource inventories in San Francisco, including surveys of Downtown, the Van Ness Corridor, Civic Center, Chinatown, the Northeast Waterfront, the Inner Richmond District, and Dogpatch. The earliest and most influential of these surveys was the Downtown Survey. Completed in 1977-78 for Heritage by Michael Corbett and published in 1979 as *Splendid Survivors*, this survey serves as the intellectual foundation for much of San Francisco's Downtown Plan. The methodology improved upon earlier surveys inasmuch as it consists of both intensive field work and thorough archival research. Buildings were evaluated using the Kalman Methodology, a pioneering set of evaluative criteria based on both qualitative and quantitative factors. A team of outside reviewers analyzed the survey forms and assigned ratings to each of the pre-1945 buildings within the survey area. The ratings range from 'A' (highest importance), to 'D' (minor or no importance).

The Aronson Building was rated an 'A' in Heritage's Downtown Survey for highest architectural significance.

Here Today

The historic resource survey and subsequent book were developed in response to a loss of historic resources in San Francisco through demolition or neglect. *Here Today* is a book published in 1968 by the Junior League of San Francisco, Inc. (Chronicle Books). The survey was adopted by the Board of Supervisors under Resolution Number 268-70 and contains information on approximately 2,500 properties within San Francisco County.

The Aronson Building was surveyed by the Junior League, though it does not appear in *Here Today*.

1976 Citywide Architectural Survey

Between 1974 and 1976, the San Francisco Planning Department conducted a citywide inventory of architecturally significant buildings. An advisory review committee of architects and architectural historians assisted in the final determination of ratings for the 10,000 buildings, which became an unpublished 60-volume inventory. Both contemporary and older buildings were surveyed, but historical associations were not considered. Typically, each building was numerically rated from a low level of importance of "-2" to a high rating of "5." The inventory assessed architectural significance, which included design features, the urban design context and overall environmental significance. When completed, the 1976 Architectural Survey was believed to represent the top 10 percent of the city's architecturally significant buildings.

The Aronson Building was included in the 1976 Citywide Architectural Survey, and was rated a "4" high architectural significance.

Department of Housing and Urban Development EIS

The Department of Housing and Urban Development (HUD) produced an Environmental Impact Statement (EIS) in 1978 for the Yerba Buena Center redevelopment area. As part of the EIS, the Aronson Building was found to be a contributing resource to the Aronson Historic District (see Historic Districts below).

Transit Center District Survey

The Transit Center District Survey (also known as the Transbay Survey) was conducted in 2008 as a component of the City of San Francisco's Transit Center District Plan. The Transit Center District Plan, currently being implemented by the San Francisco Planning Department, is an outgrowth of the 1985 Downtown Plan, in particular the latter document's policy of extending the city's urban core south of Market Street. The plan will result in new planning policies and controls for land use, urban form, building design, and improvements to private and publicly owned properties to enhance the public realm.

The Transit Center District Plan covers a section of the eastern South of Market area bounded by Market, Main, Tehama, and New Montgomery streets. At its center is the 1939 Transbay Terminal, a commuter bus station slated to be demolished and replaced with a new office tower and multi-modal transit center. In addition to the proposed 850-foot to 1,200-foot Transit Tower, there are at least seven other privately owned development projects anticipated for the near future in the surrounding area.¹

The Aronson Building was surveyed as part of the intensive-level Transit Center District Survey, and it was included in a District Record Form (DPR 523D form) as a contributing resource to a proposed New Montgomery, Mission, and Second Historic District (see Historic Districts below).

Article 10: Preservation of Historical, Architectural and Aesthetic Landmarks

San Francisco City Landmarks are buildings, properties, structures, sites, districts and objects of "special character or special historical, architectural or aesthetic interest or value and are an important part of the City's historical and architectural heritage."² Adopted in 1967 as Article 10 of the City Planning Code, the San Francisco City Landmark program protects listed buildings from inappropriate alterations and demolitions through review by the San Francisco Historic Resources Commission. These properties are important to the city's history and help to provide significant and unique examples of the past that are irreplaceable. In addition, these landmarks help to protect the surrounding neighborhood development and enhance the educational and cultural dimension of the city. As of July 2009, there are 261 landmark sites, eleven historic districts, and nine Structures of Merit in San Francisco that are subject to Article 10.

The Aronson Building is not listed in Article 10 of the San Francisco Planning Code, which means that it is not a designated San Francisco City Landmark, nor is it located within an existing local Historic District.

Article 11: Conservation Districts

Article 11 of the San Francisco Planning Code provides for the preservation of buildings and districts of architectural, historical, and aesthetic importance in C-3 Districts. A C-3 District possesses a concentration of buildings which together form a unique historic, architectural, and aesthetic character that contributes to the beauty and attractiveness of the City.³ The City requires the protection, enhancement, and perpetuation of buildings that contribute to these districts. Within the C-3 District, Conservation Districts have been designated for areas where there is a concentration of buildings that create a specialized architectural and aesthetic character. Under Article 11, resources designated as Significant, Contributory, or Category V resources will require review by the Historic Preservation Commission for any major alteration. Article 11 also requires building owners to

¹ Kelley & VerPlanck, Kelley & VerPlanck, *Transit Center District Survey* (22 July 2008) 2.

² San Francisco Planning Department, *Preservation Bulletin No. 9 – Landmarks*. (San Francisco, CA: January 2003)

³ San Francisco Planning Depart, *City and County of San Francisco Municipal Code*, Article 11, Section 1101 (b).

comply with all applicable codes, laws and regulations governing the maintenance of their properties.⁴

The Aronson Building has been identified in the Transit Center District Survey as a potential contributing resource to the Survey's proposed New Montgomery and Mission Historic District. As revised, this proposed district is referred to in the San Francisco Planning Department's "Transit Center District Plan: Draft for Public Review, Nov. 2009" as the proposed New Montgomery-Mission-Second Street Conservation District, which is an expansion of the New Montgomery-Second Street Conservation District. (The status of the Transit Center District Plan is discussed below).

Historic Districts/Conservation Districts

Aronson Historic District

The Aronson Building is rated a "2D" in the CHRIS information system because it is a contributing resource to the National Register-eligible and California Register-listed Aronson Historic District. The Aronson Historic District was created in 1978, and originally included three buildings: The Aronson Building aka Mercantile Building (1903), the Williams Building (693 Mission Street; 1907), and the Blumenthal Building aka Grace Building (87 3rd Street; 1907). Since the Aronson Building (known in 1978 as the Mercantile Building) was the dominating structure and in recognition of its original and longtime owner, Abraham Aronson, the three buildings were named the Aronson Historic District.⁵ The Blumenthal Building was a mixed-use commercial building and hotel (called "Hotel Marny" in 1913 and "Hotel St. James" in 1950). The Blumenthal Building was demolished in the 1980s, and the present building on that lot was constructed in 2002.⁶ As a contributing resource to the National Register-eligible Aronson Historic District, the Aronson Building is automatically listed in the California Register of Historical Resources.

New Montgomery-Mission-Second Street (NMMS) Conservation District

The Aronson Building is located within the boundaries of the proposed New Montgomery-Mission-Second Street (NMMS) Conservation District, which was derived from the Transit Center District Survey, completed by Kelley & VerPlanck Historical Resources Consulting in 2008 (Figure 01). The NMMS Conservation District would include the smaller extant New Montgomery/Second Street Conservation District. The Aronson Building is considered a contributor to the proposed Conservation District, which is primarily characterized by post-1906 Earthquake and Fire light industrial and commercial buildings. On August 20, 2008 the San Francisco Landmarks Advisory Board endorsed the Transit Center District Survey Historic Context Statement and survey findings.⁷ The Draft Transit Center District Plan, with the modified Conservation District, was made available for public review in November 2009.⁸ The boundaries proposed as part of the Transit Center Survey are draft boundaries and are subject to change pending the adoption of the Transit Center District Plan.

⁴ Major Alterations are defined under San Francisco Planning Department, *City and County of San Francisco Municipal Code*, Article 11, Sections 1111.1 to 1111.6.

⁵ Tad Masaoka, HUD, *E.O.11593: Determination of Eligibility Notification for the National Register of Historic Places*, Office of Archeology and Historic Preservation (27 March 1978).

⁶ This report does not assess whether the Historic District retains integrity post-demolition of the Blumenthal Building.

⁷ "Citywide Cultural and Historical Resource Survey: Recently Completed Surveys, Transbay Survey," San Francisco Planning Department. Website accessed on 8 April 2009 from:

http://www.sfgov.org/site/planning_index.asp?id=77341#transbay.

⁸ San Francisco Planning Department, "Transit Center District Plan: Draft for Public Review, November 2009." Website accessed on 1 April 2010 from: http://www.sf-planning.org/ftp/CDG/docs/transit_center/Transit_Center_District_Plan_Public_Draft_WEB.pdf



Figure 01. Boundaries of proposed New Montgomery-Mission-Second Street Conservation District (brown). Page & Turnbull has highlighted the Aronson Building in red and outlined the current New Montgomery-Second Street Conservation District in pink.

Source: San Francisco Planning Department, "Transit Center District Plan: Draft for Public Review, Nov. 2009."

Methodology

Page & Turnbull surveyed the Aronson Building and its immediate surroundings during a site visit conducted during the week of March 1, 2010. Page & Turnbull reviewed all known reports, drawings, and previously completed historic research supplied by 706 Mission Street Co., LLC. Further historic research was also conducted at the San Francisco Public Library, the San Francisco Historic Photograph Collection, the Bancroft Library at UC Berkeley, and Page & Turnbull's in-house library. The intent of this document is to serve as a reference and guide for future project planning at the Aronson Building.

Client Team

Client/706 Mission Street Co., LLC

Kristin Gonsar

706 Mission Street Co., LLC
301 Mission Street, Level B1
San Francisco, CA 94105

Consultant Team

Preservation Architect
Page & Turnbull, Inc.
1000 Sansome Street, Suite 200
San Francisco, CA 94108
T: 415.362.5154 F: 415.362.5560
Jay Turnbull, Elisa Skaggs, Erin McCloskey,
Christina Dikas

PART I. DEVELOPMENTAL HISTORY

A. HISTORICAL BACKGROUND AND CONTEXT

The following section frames the history and significance of the Aronson Building within the context of the broader development and historical events of San Francisco's South of Market neighborhood. It provides the necessary background for the evaluation of the resource for its eligibility for listing in the National Register of Historic Places and the California Register of Historical Resources.

Early San Francisco History

European settlement of what is now San Francisco took place in 1776 with the simultaneous establishment of the Presidio of San Francisco by representatives of the Spanish Viceroy, and the establishment of Mission Dolores by Franciscan missionaries. The era of Spanish colonial rule was relatively brief. In 1821 Mexico declared independence, taking with it the former Spanish colony of Alta California. During the Mexican period a small village grew up along a sheltered cove at the tip of the San Francisco peninsula. This sleepy village, which was called Yerba Buena, served as a minor trading center inhabited by a few hundred people of diverse nationalities. In 1839 a few streets were laid out around a central plaza (now called Portsmouth Square), which was ringed by commercial and civic buildings. Not long after the American takeover of California in 1846, a surveyor named Jasper O'Farrell laid out Market Street from what is now the Ferry Building to Twin Peaks. Blocks north of the survey line were laid out in 50 *vara* square blocks, whereas blocks south of Market were laid out in larger 100 *vara* blocks. (A *vara* is a Spanish unit of measurement equivalent to 2.77 feet.) In 1847, the name Yerba Buena was changed to San Francisco.

The discovery of Gold at Sutter's Mill in 1848 unleashed a massive wave of immigration as thousands of would-be gold-seekers made their way to the isolated outpost at the western edge of North America. Between 1846 and 1852, the population of San Francisco mushroomed from less than 1,000 people to almost 35,000. The short supply of level land around Portsmouth Square soon pushed development up the slopes of Nob Hill or south to Market Street. Development also moved eastward into the cove on filled tidal lands. Development of early San Francisco was concentrated around downtown, and the outlying portions of the peninsula remained unsettled throughout most of the city's early history.

With the decline of gold production in 1855, San Francisco's business community began to embrace other economic opportunities such as agriculture, construction and banking.⁹ Prospering from these new industries, an elite group of merchants, bankers, and industrialists arose to guide the development of the city. In the following decades, San Francisco's population continued to grow owing to its position as the foremost financial, industrial and shipping center of the West. By 1870 the population had reached 150,000, and just twenty years later the population doubled to almost 300,000.

South of Market Neighborhood, Northeast

The South of Market neighborhood (also known as SoMa) is located in the northeastern part of San Francisco. As the name suggests, the northern border of the neighborhood is Market Street, while the area is also roughly bounded by the San Francisco Bay and the Embarcadero to the east, Mission Creek and 13th Street to the south, and South Van Ness Avenue to the west. The northeastern part of the South of Market is roughly bounded by Market Street to the north, Main Street to the east, Folsom Street to the south, and 3rd Street to the west.

⁹ Rand Richards, *Historic San Francisco. A Concise History and Guide* (San Francisco: Heritage House Publishers, 2001) 77.

Historically, the northeastern part of the South of Market has contained somewhat different buildings and uses than the rest of the neighborhood because it has long been considered an extension of Downtown, combining commercial high-rises with working class light industrial and residential uses. It also developed earlier than the rest of the neighborhood, and was reconstructed much quicker following the 1906 Earthquake and Fire.

Prior to the Gold Rush of 1849, the most eastern part of the South of Market area was submerged under water, while the rest of the northeastern area was occupied by sand dunes and narrow wooded valleys. A protected area amidst the sand dunes, bounded by Market, Howard, 1st and 2nd streets, was first settled by squatters in 1849. The settlement was called “Happy Valley” by the forty-niners. By the summer of 1850, residents had begun erecting more permanent stores and houses.¹⁰ This northeastern part of the South of Market developed earlier than the rest of the neighborhood because it was located closest to Downtown San Francisco.

Sand removal in the South of Market area proceeded from about 1850 to 1873. The sand was used to fill Yerba Buena Cove and extend the street grid eastward into the bay. The removal of the hills facilitated street grading on the newly level ground.¹¹ For example, between 1853 and 1857, 3rd Street was graded from Market Street to Steamboat Point. The streets were initially paved with thick wooden planks, and were called “plank roads.” Beginning in the 1850s, the 100-*vara* blocks were also subdivided into smaller, more easily developable units through the creation of many narrow back alleys, including Minna, Natoma, and Hunt streets.¹²



Figure 02. Looking north from 2nd and Folsom Streets, 1866.
Source: San Francisco Historical Photograph Collection,
AAB-5750.

¹⁰ Kelley & VerPlanck, *Transit Center District Survey* (22 July 2008) 18.

¹¹ *Ibid*: 19.

¹² *Ibid*: 22.

The northeastern South of Market area continued to develop in the nineteenth century, and the residential settlement of inexpensive frame cottages and tenements was interspersed with a burgeoning iron foundry industry. The 1859 Comstock Lode Boom increased land prices in the neighborhood, and multi-story brick and stone buildings began to take the place of the simple Gold Rush-era frame dwellings (**Figure 02**). Commercial services clustered along 3rd Street and around the intersections of 2nd and Mission, New Montgomery and Mission, and 1st and Howard streets. Commercial services included hundreds of saloons, groceries, dry goods stores, bakeries, butchers, shoemakers, seamstresses, public bathhouses, doctors and dentists, social organizations, houses of prostitution, and undertakers.¹³ Despite becoming more established, pioneer developers did not provide any parks or similar amenities for their working class residents in the South of Market.

The residents included a large number of immigrants, predominately Irish, German, and Chinese, who made their way across the country, especially after the opening of the Transcontinental Railroad in 1869.¹⁴ Overcrowding became the norm as workers who needed to live within walking distance to their industrial and longshoreman jobs doubled and tripled-up in apartments and flats. Even the areas south of Market Street that were once considered elite sectors, such as Rincon Hill and South Park, were converted from large single-family houses to rooming houses.¹⁵ At the same time, a dichotomy emerged as New Montgomery Street was constructed in the early 1870s to extend Montgomery Street south of Market. Though much of the area was working class and industrial in nature, New Montgomery Street was planned as an extension of Downtown, and became an upscale office, banking, retail, and hospitality district.¹⁶

By 1900, the northeastern part of the South of Market area was completely built out. However, on April 18, 1906, the neighborhood was nearly completely destroyed by a great earthquake and the ensuing fires that broke out as a result of broken gas mains (**Figure 03**). The fires grew out of control as they were fed by the densely packed wood-frame buildings. The entire neighborhood was consumed within six hours of the temblor, and only a small handful of steel-frame, brick, and stone-clad buildings remained standing—including the Aronson Building. The death toll in the South of Market Area was much higher than the rest of the city because many cheaply built hotels and boarding houses collapsed on their inhabitants.¹⁷

The South of Market neighborhood took at least a decade to recover. Wrecked buildings had to be demolished and the ruins carted away, insurance claims settled, title questions resolved, land surveyed, building permits acquired, and materials and

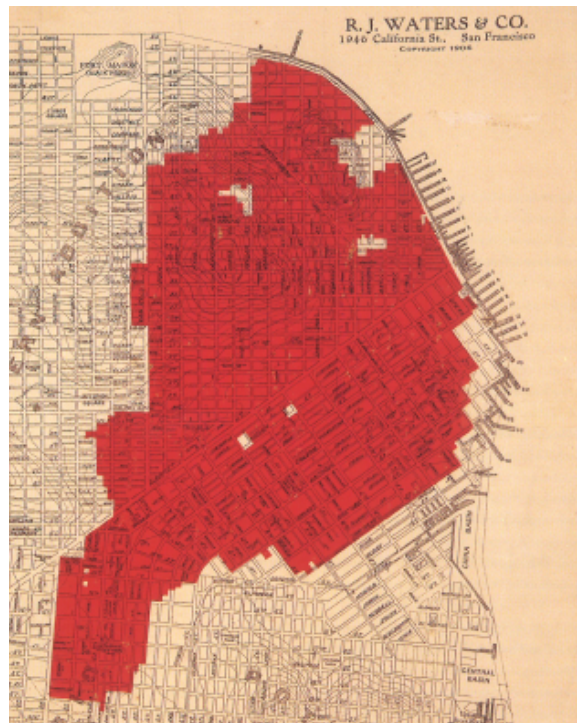

Figure 03. Map of the Fire Area by R.J. Waters & Co., ca. 1906

Source: Sally B. Woodbridge, *San Francisco in Maps & Views* (New York: Rizzoli, 2006) 117.

¹³ Ibid: 27.

¹⁴ Ibid: 24.

¹⁵ Ibid: 26.

¹⁶ Ibid: 29.

¹⁷ Ibid: 31-32.

contractors secured. In many ways, the South of Market area was uniquely affected by the disaster due to uncertainty over whether pre-quake land uses, in particular wood-frame residential construction, would be allowed to be rebuilt.¹⁸ Though the Board of Supervisors eventually decided on a blanket prohibition on flammable roofing materials, the uncertainty caused many residential property owners to sell to real estate syndicates who assembled residential lots into larger commercial and industrial lots.¹⁹



Figure 04. Residential hotels and commercial buildings on 3rd Street near Howard Street, 10 August 1964.

Source: San Francisco Historical Photographs Collection, AAB-5842.

An initial flurry of building activity occurred between 1906 and 1913, and was largely represented by new and reconstructed steel and heavy timber-frame industrial loft buildings housing light manufacturing, paper companies, printers and binderies, and wholesale warehouses. The area developed further as the southerly extension of Downtown when a large number of skyscrapers on Mission, Market, and New Montgomery Streets were constructed. This building boom was followed by a recession that coincided with the First World War. The market picked up again in the early 1920s, and many new reinforced concrete light industrial and commercial buildings were constructed during this time. Cafeterias, saloons, gambling parlors and pool halls, public baths, and other retail and service shops were established on 3rd Street between Market and Folsom streets (**Figure 04**), while employment offices, missions, and other social service agencies were clustered on Howard and Folsom streets.²⁰ Little residential construction occurred in the northeastern part of the South of Market neighborhood, but several wood-frame and masonry residential hotels were built on 3rd Street to house the working class men who continued to live and work in the area. A handful of wood-frame single-family cottages and flats were constructed to house working class families.²¹

Major changes to the northeastern part of the South of Market area occurred in the 1930s and again in the 1960s. Large public works projects in the 1930s altered the neighborhood, including

¹⁸ Ibid: 32.

¹⁹ Ibid: 33-34.

²⁰ Ibid: 37.

²¹ Ibid: 36.

construction of the San Francisco-Oakland Bay Bridge approach and the Transbay Terminal in 1936. In 1966, the San Francisco Redevelopment Agency approved the Yerba Buena Redevelopment Area, which was created to counter the supposed “skid row” that had existed in the northeastern South of Market. The urban renewal plan focused on an area bounded by Mission, 3rd, Harrison, and 5th streets with the vision of replacing the derelict commercial, light industrial, and residential buildings with a civic arena, convention center, and parking garage (**Figure 05**). Though local working class residents vehemently opposed the plan, it nonetheless was eventually carried through. Construction projects included Moscone South (1981), Moscone North (1992), Yerba Buena Gardens (1994), the San Francisco Museum of Modern Art (1995), the Children’s Center (1998), and Moscone West (2003). The two-square block Yerba Buena Center and Moscone Convention Center displaced approximately 4,000 residents and 700 businesses.²²

In addition to these major changes, other parts of the northeastern South of Market area have been redeveloped beginning in the 1970s, through the construction of many Corporate Modern, Brutalist, and Post-Modern style skyscrapers. Though clusters of earlier post-quake buildings remain, the population, building stock, and functional characteristics in the northeastern South of Market area have greatly changed since the mid-twentieth century.



Figure 05. Construction of Moscone Convention Center, 1980.
Source: San Francisco Historical Photograph Collection, AAC-0724.

²² Ibid: 47.

The Aronson Building

The site of 700-710 Mission Street/86 3rd Street appears to have been developed as early as 1853 (**Figure 06**). By 1859, half the block bounded by Mission and 3rd streets was lined with buildings (**Figure 07**).



Figure 06. U.S. Coast Survey Map (1853), with site of Aronson Building highlighted. Source: Sally B. Woodbridge, *San Francisco in Maps & Views* (New York: Rizzoli, 2006) 59.



Figure 07. U.S. Coast Survey Map (1859), with site of Aronson Building highlighted. Source: Sally B. Woodbridge, *San Francisco in Maps & Views* (New York: Rizzoli, 2006) 46.

The 1899 Sanborn Fire Insurance Map reveals that the site of the Aronson Building was occupied in the late-nineteenth century by three buildings containing saloons and shops, a photo gallery and restaurant, a candy maker, and lodgings above (**Figure 08**). Two of the buildings were two stories in height, while the third was three stories. Adjacent to the site on 3rd Street were buildings occupied by stores at the first floor and lodging above, and the Winchester House and Winchester Hotel. The Grand Opera House was located immediately to the west on Mission Street.

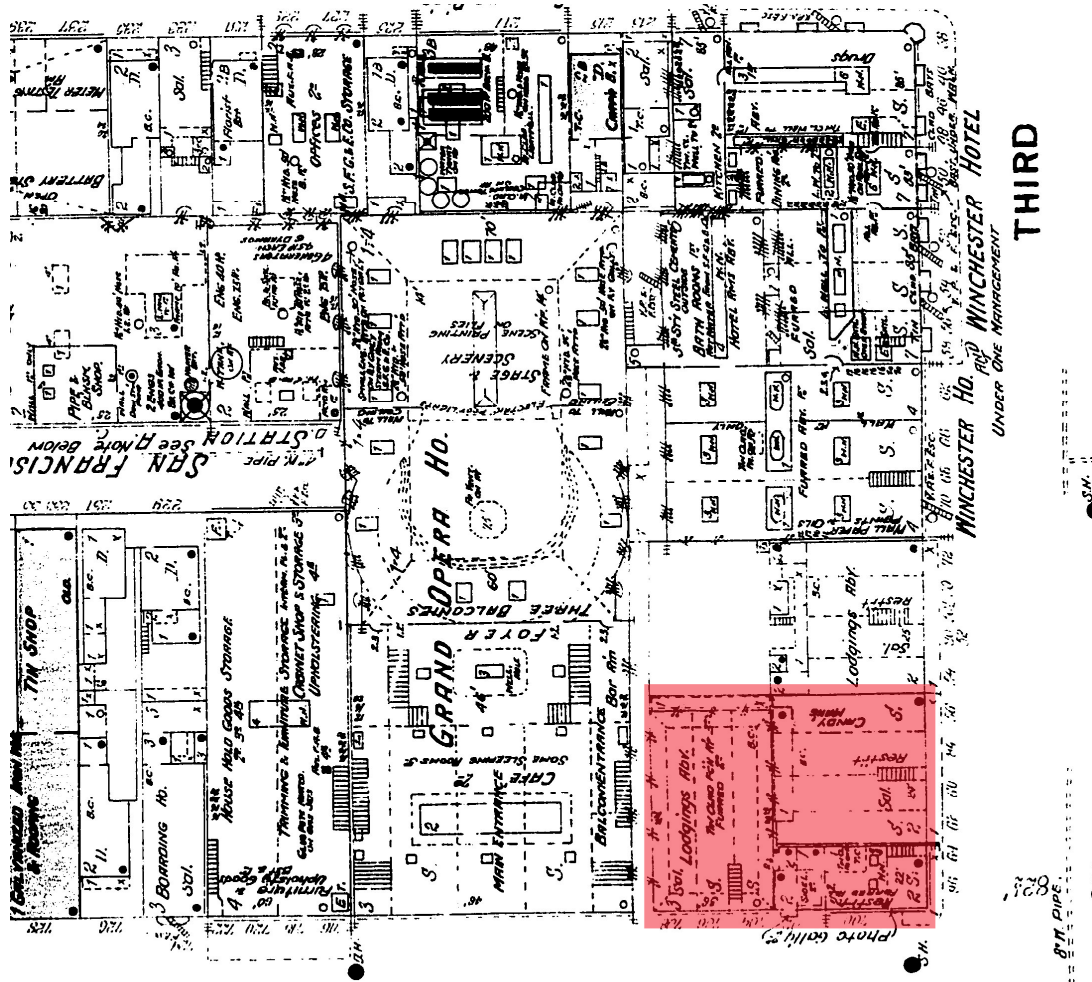

Figure 08. Sanborn Fire Insurance Map (1899), with site of Aronson Building highlighted.

The Aronson Building was constructed in 1903. The three previous buildings on the site were likely demolished at that time to make way for the new building. Construction cost \$700,000, including the land, which cost \$290,000. The building was named after Abraham Aronson, the project’s real estate developer, and was the first major commercial building in San Francisco to bear the name of a Jewish person. It was also the largest and most expensive building under private ownership to be built south of Market Street and west of New Montgomery Street at the time.²³ The building was designed by the architecture firm of Hemenway and Miller, and occupied the entire original lot of 85’ x 107’ (Figure 09).²⁴ As architectural historian Michael Corbett explains, “The building dominated its corner by combining traditional elements more commonly found in the better neighborhoods north of Market with more purely functional dualities of the South of Market area.”²⁵

The building was designed in the Chicago School style of architecture with a three-part horizontal composition, though without three-paned “Chicago windows.” It was reminiscent of the work of the famed Chicago School architect Louis Sullivan, who designed his buildings like a classical column, with retail in the “base,” offices in the “shaft,” and mechanical equipment in the “capital.” The small

²³ “Third and Mission Street Structure,” *The San Francisco Chronicle* (28 December 1902) 12.

²⁴ Knapp Architects, *Supplemental Information Form for Historic Resource Evaluation, 706 Mission Street* (September 2008), Property History: 1.

²⁵ Michael Corbett, *Untitled history of the Aronson Building* (April 1975).

round windows resemble Sullivan's Guaranty and Wainwright Buildings.²⁶ In fact, the Aronson Building is often regarded as being the best example of a Chicago School style skyscraper in San Francisco. Regarding the design of the building's structure and exterior facades, Knapp Architects explains,

In a growing city which had burned to the ground on several occasions, architects and builders were keenly aware of the need for fireproof construction techniques. The steel skeleton structure of the Aronson Building supported Roebling System B cinder concrete floor slabs which were reinforced with expanded metal mesh. Partitions throughout were 4" thick hollow terra cotta tile blocks. For fireproofing the steel structure, some columns were clad with terra cotta tile blocks, while others were encased in concrete.

The street facades had cast iron pilasters at ground level, and intermediate supports of the same material on the second floor which were fabricated by Vulcan Iron Works of San Francisco. Early photographs show much more glass on the storefront than seen today, including in the transom areas. A 1906 photo shows the frame of a cantilevered or suspended canopy on the south corner freight elevator entrance, which does not appear in earlier photographs. The primary infill above was faced in yellow brick. Other decorative features were reportedly carved from Arizona red sandstone and the exuberant and deeply carved ornamentation near the cornice was of terra cotta. [Colusa sandstone may have ultimately been used, or the Arizona red sandstone was replaced with Colusa sandstone in 1906.] The clay products were fabricated by Gladding, McBean & Co. The original metal cornice may have been copper. The northwest face, highly visible from Market Street, was common red brick which, over time, saw many advertisements painted upon it. ...

The first floor original held four retail spaces. Two entrances had "marble vestibules and staircases, with two high-speed elevators at the Third Street entry and two freight elevators on the opposite corner."²⁷



Figure 09. Looking north on 3rd Street, 1905.
Source: Bancroft Library.

²⁶ Charles Hall Page & Associates, Historical Resource Inventory, DPR523 for the Mercantile Building (July 1978).

²⁷ Knapp Architects, Property History: 1-2.

When the 1906 Earthquake hit, ensuing fires obliterated nearly every building in the South of Market, Downtown, and into the Mission District. Due to the fireproof construction of the Aronson Building's structure, however, the building survived the disaster (**Figures 10, 11, 12, and 13**). Although the existence of historic drawings is unknown, there was considerable discussion surrounding the Aronson Building's structural system after the earthquake. The building was studied and published extensively in architectural and engineering periodicals. Additionally, in 1906, the Roebling Construction Company published *The San Francisco Earthquake and Fire – A Brief History of the Disaster: A Presentation of Facts and Resulting Phenomena, with Special Reference to the Efficiency of Building Materials Lessons of the Disaster*. The following is the publication's findings on the Aronson Building:

Details of Construction

The Aronson Building is a nine-story and loft building, about 80' x 90' in plan. The facades consist of Colusa sandstone for the lower three stories and buff pressed terra cotta brick with terra cotta ornaments above. The cornice is of terra cotta and copper. The west and south walls are of common brick, and all the walls are self-supporting.

The floors are supported by steel columns, girders and beams. The fire-proof floors are of the Roebling System B or flat slab type of stone concrete, the spans being about 6-1/2 ft. between beams. The partitions throughout are of 4" hollow tile blocks. The steel columns are protected with 3" hollow tile blocks except two in the basement which have concrete protection. The soffits of the girders and beams are covered with crimped wire lath and cement plaster. The floor finish was of wood, laid on sleepers and sleeper fill.

Effects of the Fire and the Earthquake

The sand-stone of both fronts is badly spalled by the fire, and on the Third Street side is considerably cracked by the quake. The pressed brick and terra cotta above is in good condition. At the third-story level the walls between window openings are badly cracked by the earthquake. The northeast corner at the first story is badly racked. The north and west walls of common brick are in fair condition. All the walls are practically plumb, the greatest variation from the plumb being at the southeast corner, where the south front leans to the north about 3/8". The levels on the water table do not disclose any material displacement of the foundation.

One of the columns in the basement on the east side has buckled. In the southwest corner of the first story, two columns have buckled near the ceiling. The failure of one of these was caused by the bulging of pipes within the fire-proof protection. In the northwest corner in the fifth story, one of the columns buckled so that the floors settled about 18". On the eighth floor, in the northwest corner of the building, another column is badly buckled. The same column on the tenth story buckled also. One column deflected slightly in this story.

The concrete floors throughout are in first-class condition, successfully carrying a number of large safes that were located in different parts of the building. The 4" hollow tile partitions are generally wrecked, about 60 percent of the entire work having fallen down. The wall furring is badly cracked, and is down in spots. The hollow tile column protection is greatly damaged throughout, 50 percent or more having fallen away from the columns of the first story, and approximately an average of about 15 percent has fallen away from the columns in the other stories. The concrete column protection in the basement is in fair condition, although not of good quality originally. The 4" tile partitions around the stairway and elevator enclosure on the north side collapsed throughout, many of the blocks falling on the stairway and wrecking it.

The wire lath and cement plaster on the soffits of the beams and girders are in good condition. The suspended wire lath and plaster ceiling on the top story is intact. The cast-iron stairway and elevator fronts on the west side are greatly damaged and the stairway on the north side is completely wrecked.

Comments

The intensity and duration of the fire was normal and such as would naturally result from the combustion of considerable stock, wood-finish, furniture, etc., in a building of this character. The sand-stone portions of the front will require renewal. The several columns that have been buckled can be replaced. The elevator fronts, stairways, partitions, column protection and all the plaster work must be completely renewed and rebuilt.

An opportunity of comparing the efficiency of hollow tile blocks and concrete for column protection was afforded in the basement, where both materials were used for this purpose. One of the columns covered with hollow tile blocks buckled very badly, and the protection is damaged around other columns. The columns protected by concrete remain straight and uninjured, although one of them is within 15 ft. of the badly buckled column referred to and was apparently subjected to the same conditions.²⁸



Figure 10. During and after the 1906 Earthquake and Fire. The Aronson Building is located on the right.
Source: California Historical Society



Figure 11. The Aronson Building is on the left.
Source: San Francisco Historical Photograph Collection, AAC-3600.

28 A.L.A. Himmelwright, *The San Francisco Earthquake and Fire – A Brief History of the Disaster* (The Roebling Construction Company, 1906)



Figure 12. The caption to this 1906 newspaper photo reads: "ARONSON BUILDING. Northwest Corner Third and Mission Streets. The facades for the three lower stories consist of Colusa sand-stone, which is badly spalled and damaged. The upper stories of buff terra cotta pressed brick, with terra cotta ornaments, are but slightly injured, the terra cotta being spalled and cracked in a few places. The metal cornice is completely wrecked. The rear walls of common brick were considerably racked and damaged by the earthquake. All the walls remain practically plumb. Columns in the basement, first, fifth, eighth and tenth stories have buckled on account of the failure of the hollow tile protection. The Roebling concrete floors, with crimped wire lath and cement plastered soffit protection, remain in first-class condition throughout, notwithstanding the warped condition of the steel work, due to the buckling of the columns. The 4" hollow tile partitions are badly wrecked throughout, about 80 percent of the entire work having fallen down. The failure of the hollow tile partitions totally wrecked the cast-iron and marble tread stairways." Source: Unknown (clipped file).



Figure 13. Buckled I-beam encased in failed hollow tiles in the basement, 1906. Source: Bancroft Library.

Despite survival of the building's skeleton and exterior cladding, much of the interior, exterior ornament, and windows required replacement. Aronson financed reconstruction, which was estimated on the building permit dated December 28, 1906 to cost \$100,000 (**Figure 14**).



Figure 14. Reconstruction of the Aronson Building, ca. October 1906.
Source: California State Library.

The rehabilitation followed closely the original exterior design and ornament, though the storefronts were altered by infilling the Mission Street storefronts with solid walls and small, highly placed windows to act as the secondary façade of a corner saloon (**Figure 15**). According to the 1913 Sanborn Fire Insurance Map, the building contained three stores and the saloon facing 3rd Street (88, 90, 92, and 98 3rd Street) and two small stores facing toward the southwest on Mission Street (708 and 710 Mission Street) (**Figure 16**). The entrance to the upper floors was located at 86 3rd Street, and contained two elevators. Two freight elevators were located near the west corner of the building. The Aronson Building was labeled “fireproof construction – steel frame and brick.”

Abraham Aronson sold the building in 1938, and the 86 3rd Street lobby was reportedly remodeled after that time. With the sale, the building's name was changed to the Mercantile Building.



Figure 15. The Aronson Building at 3rd and Mission streets, ca. 1909.
Source: San Francisco Historical Photograph Collection, AAB-4731.

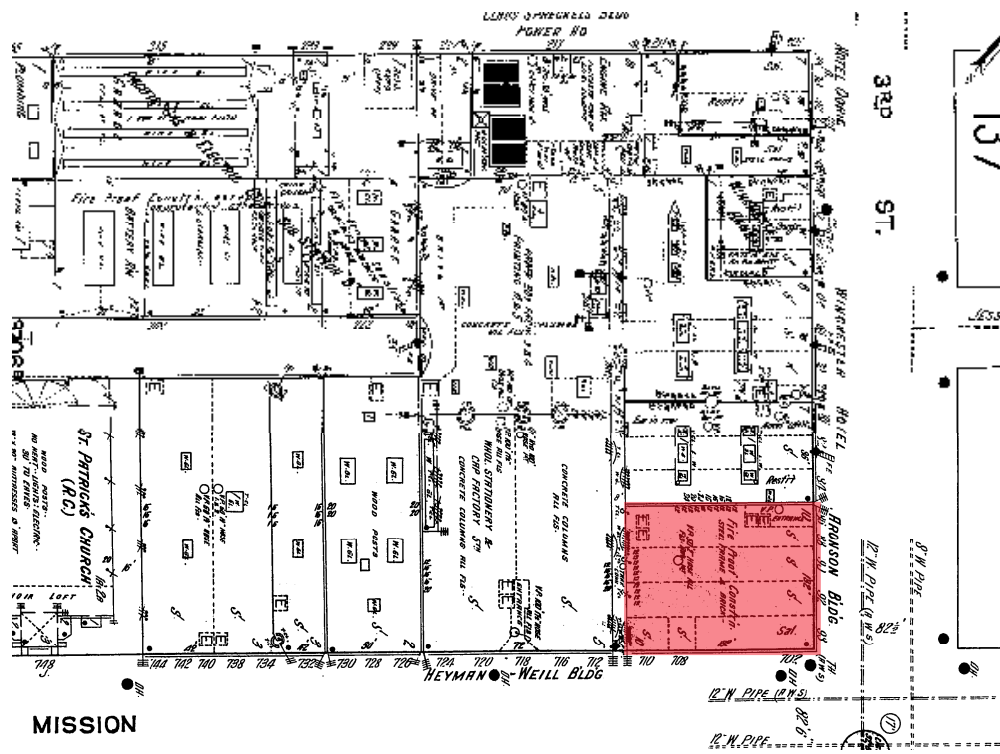

Figure 16. Sanborn Fire Insurance Map (1913), with site of Aronson Building highlighted.

According to the 1950 Sanborn Fire Insurance Map, the building was labeled the “Mercantile Center Bldg” (Figure 17). The main entry to the upper floors was still a long narrow lobby running from 3rd Street to the southwest. Three stores at 88, 90, and 92 3rd Street and two stores at 708 and 710

Mission Street remained unchanged. However, the corner saloon that existed in 1913 was divided into two small stores that faced 3rd Street (96 and 98 3rd Street) and two stores and a restaurant that faced Mission Street (700, 702, and 704-706 Mission Street). The 1950 Sanborn Map erroneously states that the building was constructed in 1906.

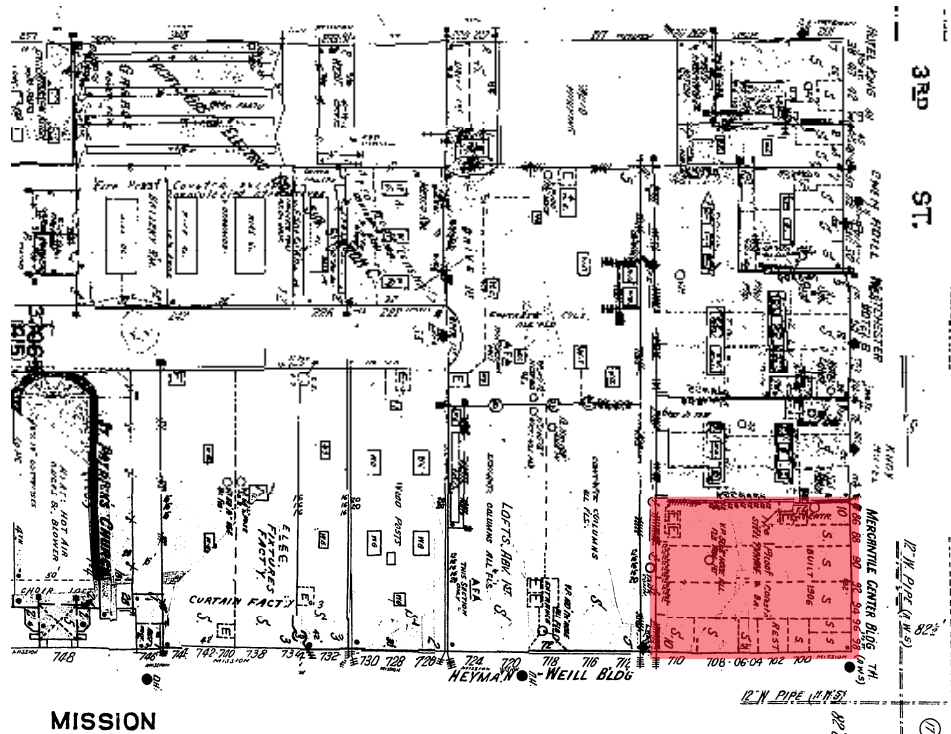

Figure 17. Sanborn Fire Insurance Map (1950), with site of Aronson Building highlighted.

Between 1938 and 1971, the building was owned by a succession of individuals and corporations. The San Francisco Redevelopment Agency acquired the property for \$93,000 through a legal action, and enlarged the lot size to 105' x 147.' The building was intended to be demolished after the Yerba Buena Center redevelopment district was established in 1966. In March 1975, the building was slated for demolition, following engineering studies that indicated that it was not feasible to rehabilitate the steel-frame structure. The site was to be used as a plaza near a proposed theater on the Yerba Buena Center's central block. The building was emptied of its tenants, except for those on the ground floor, including Rochester Big & Tall and Fox's Sandwich Shop. However, by the following June, the property received a reprieve from demolition.²⁹ This occurred due to an effort begun by San Francisco Architectural Heritage and endorsed by the San Francisco Landmarks Preservation Advisory Board.³⁰

T/W Associates acquired the property in 1978 from the San Francisco Redevelopment Agency. The building went through significant changes that year, when a building permit was issued for an estimated \$1,500,000, which included the construction of a ten-story addition covering the entire southwest façade and a three-story addition to the northwest (**Figures 18 and 19**). Most of the core functions, including passenger elevators and stairs, were moved to the southwest addition at that time, except for the freight elevator, which was placed in one of the original passenger elevator shafts.³¹

²⁹ Knapp Architects, Property History: 1-2.

³⁰ San Francisco Architectural Heritage, *Heritage News* (xxxiv:2) 7; Dan Borsuk, "Doomed Building has Reprieve," *The San Francisco Chronicle* (20 June 1975).

³¹ Knapp Architects, Property History: 2-3.



Figure 18 and 19. The Aronson Building, ca. 1970s
Source: Turnstone Consulting.



Figure 19. The proposed design for the southwest addition, ca. 1978.
Source: Turnstone Consulting.

According to a 1989 Sanborn Fire Insurance Map, the additions were completed in 1981 (See “**Chronology of Development and Use**” for a summary of alterations and additions). The Sanborn Map also shows that the entire building is fireproof—brick at the original building and concrete at the additions (**Figure 20**). At that time, two commercial spaces faced 3rd Street (88 and 90-98 3rd Street), and one faced Mission Street (710 Mission Street). The address of 706 Mission Street was applied to the upstairs offices, which were accessed via the southwest addition.

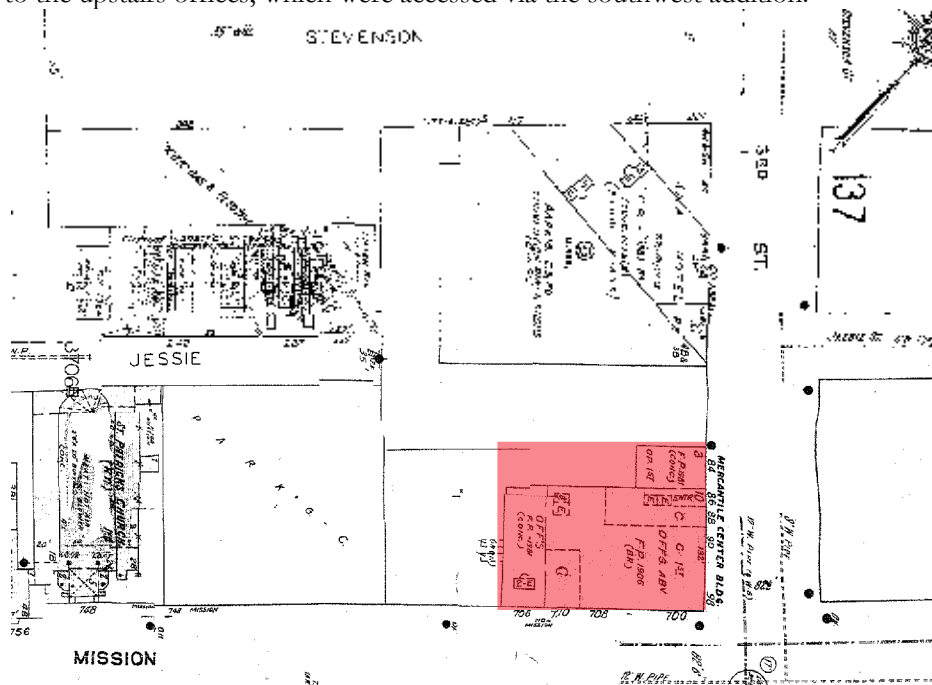

Figure 20. Sanborn Fire Insurance Map (1989), with site of Aronson Building highlighted.

Owners and Occupants

Owners

The Aronson Building has been owned by several individuals and corporations. From the building's construction in 1903 until 1925, the property was owned by developer Abraham Aronson. Mercantile Trust Co. of California, later known as the American National Co., owned the property from 8 May 1925 to 12 June 1928. Abraham Aronson and Nettie Aronson were listed in sales records as owners from 12 June 1928 to 21 June 1938.

Following the Aronson's' sale, ownership of the property was transferred through a succession of names, including the Northwestern Mutual Insurance Co. from 21 June 1938 to 25 February 1942; Bernard Weinstein from 25 February 1942 to 17 July 1944; Panama Realty Company from 17 July 1944 to 29 December 1949; Hilary J. Bevis and Marion M. Bevis from 29 December 1949 to 18 June 1958; Bethlehem Pacific Coast Steel Corporation on 18 June 1958; R.C. Pauli and Sons from 18 June 1958 to 23 May 1960; Larinda Corporation from 23 May 1960 to 16 May 1966, Harold E. Pauli, et al on 16 May 1966; Lazzareschi Investment Co. on 16 May 1966; and Eighty-six Third Street Association from 16 May 1966 to 7 June 1971.

On 7 June 1971, the Redevelopment Agency of the City and County of San Francisco acquired the property through a legal action; Western Title and Insurance Co. briefly possessed ownership from 20 September 1978 to 29 September, before transferring back to the Redevelopment Agency. T/W Associates purchased the Aronson Building on 20 October 1978, and were owners until 2006. 706 Mission Street LLC has possessed ownership from 23 January 2006 to the present.

Occupants

Two of the earliest occupants of the Aronson Building were Ditmes Woolen Mills, which rented the sixth floor, and California Glove Co., which rented the seventh floor, in June 1904.

The longest and most prominent occupant has been the clothing company Rochester Big & Tall. Originally known as "Rochester Clothiers," the company was founded in 1906 to provide uniforms and work clothes, and has been located in the Aronson Building since 1918. Over time, the business expanded from one to four tenant spaces before consolidating most of the ground floor under the address 700 Mission Street in 1964. In 1968, the company added a mezzanine level inside the store.³² In the 1960s, the company was called "Rochester Clothing," but had changed its name to "Rochester Big & Tall" by 1978.

Over the years, the ground floor storefronts have contained a saloon, cigar store, G.E. Biddell & Co., photo supplies, U.S. Sewing Machine Co., barber shop, Army & Navy Tailor, bookstore, Bea's Coffee Shop, and Fox's Sandwich Shop. Upper floors of the Aronson Building (86 3rd Street) have primarily contained clothing manufacturers, though realtors, manufacturers' agents, architects, and accountants have also occupied offices there. Many businesses were only located in the building for a short time (less than five years), though a few stayed for over ten years.

According to San Francisco City Directory research, other occupants have included the following (not a complete list)³³:

³² Knapp Architects, Property History: 2.

³³ The reverse City Directories (listed by address, not by business name) are available for 1936, 1940, and every year between 1953 and 1982. Beginning with 1953, directory listings at intervals of five years were recorded.

*Aronson Building
Historic Structure Report*

Business	Occupation	Dates of Occupancy
Aronson Insurance Company	insurance	ca. 1936
Aronson Realty Co.	realtors	ca. 1936
California State of Emergency Relief Administration	government office	ca. 1936
JB Crowley Inc.	wholesale notions	ca. 1936-ca. 1940
Dun & Bradstreet Inc.	general office/commercial consumer inq./reports; credit ratings; mercantile claims	ca. 1936-ca. 1968
Eastman Cutting Machine Co.		ca. 1936-ca. 1940
Heastand BF Co.	crocery etc.	ca.1936-ca.1958
E. Leitz Inc.	microscopes	ca. 1936-ca. 1940
Ruby Ring Hosiery Co.	hosiery	ca. 1936-ca.1940
Universal Button Co.	buttons	ca. 1936-ca. 1940
Northwest Mutual Life Insurance	insurance	ca. 1940
Arthur Allen Clothiers	clothiers	ca. 1940
Artistic Weaving Co.	weaving	ca. 1940
Pacific Optical Co.	optical	ca. 1940
Van Baalen- Heilbrun Co.	men's furnishings wholesale	ca.1940-ca. 1968
Cooper Underwear Co./Cooper's Inc.	underwear/wholesale knit goods	ca.1940-ca. 1953
Girl Scouts Inc.	service organization	ca. 1940
Noide & Horst Sales Co.	hosiery	ca. 1953
Druehl Sales Co.	manufacturers agent	ca. 1953-ca. 1958
Webster Optical Co.	optical	ca. 1953-ca. 1968
Top Secret Hosiery Sales Co. Inc.	hosiery	ca. 1953
Hale Bros. Department Store	wholesale division warehouse	ca. 1953-ca. 1958
US Public Utilities Commission	transit division field section	ca. 1953-ca. 1958
Pioneer Suspender	suspenders	ca. 1953-ca. 1958
Wilson Bros.	men's furnishings wholesale	ca. 1953
Cates & Ganong Association	manufacturers agent	ca. 1953
Manhattan Shirt Co.	shirts	ca. 1953- ca. 1958
Phillips-Jones Corp	wholesale men's furnishings	ca. 1953- ca. 1958
Beta Pac Royal Inc.	general merchandise wholesale	ca. 1958
Mansure EL Co. of California	upholstery fabrics	ca. 1958- ca. 1963
Dobbins Associates Inc.	manufacturers agent	ca. 1958
Joe E. Thompson & Son	men's furnishings wholesale	ca. 1958-ca. 1968
Larinda Corps.	investors	ca. 1963
Edith of California	women's clothing manufacturer	ca. 1963-ca. 1968
The Pauli Co.	real estate	ca. 1963
The Reecy Corp.	machinery	ca. 1963-ca. 1968
Prager & Bear	manufacturers agent	ca. 1963
Donald Francis Haines & Associates	architects	ca. 1963-ca. 1968
Tatrian Zaven	architect	ca. 1968
H. Degenkolb & J. Associates	structural engineers	ca. 1968
Liebman & Guggheimer Inc.	leather manufacturers	ca. 1968
VACANT (all floors)		ca. 1973-ca. 1978

On the whole, the ground floor is recognized for long-time inhabitation, and incremental consolidation, by Rochester Big & Tall. The upper floors are mostly recognized for their occupants in the garment manufacturing business.

Developer and Architect

Abraham Aronson

According to the *Supplemental Information Form for Historic Resource Evaluation* by Knapp Architects,



Figure 21. Portrait of Aronson, ca. 1917.
Source: Martin M. Meyer, *Western Jewry*,
p.163-164.

Abraham Aronson was born in Calvria, Russian Poland on September 1, 1856. Preceded by his father, he and his mother immigrated to the United States in 1869, first to New York for a short time and then on to San Francisco the next year. He attended Lincoln Night School and City Business College. In 1871, he opened a business selling furniture which was located in the North Beach district. He was married in 1882 to California-born Amelia Rosenthal of Grass Valley, and by 1900 they had two sons and two daughters. About 1886, he built a large structure on Stockton Street to house his expanding furnishings enterprise. He continued with this business until 1894, when he changed his career focus with the creation of Aronson Realty Company and started buying old buildings and replacing them with new high end structures. After the death of his wife in 1903, he married Nottie Rosenthal in 1907. He was very involved with a great many Jewish-related associations, including chairman of the building committee for the original Temple Sherith Israel building. In 1911, he made an unsuccessful bid for the San Francisco Board of Supervisors.

In 1903, Aronson's own office was located at 340 Post Street while he and his family resided at 1720 Sacramento Street, San Francisco. His business address just after the 1906 event was 511 Eddy Street. Aronson also developed many other properties in San Francisco.³⁴

By early 1906, Aronson had erected some twenty buildings, including the Redondo Hotel on Post Street, near Jones; the San Francisco News Company's building on Geary Street, near Powell; the Bullock & Jones Building on Sutter Street, near Montgomery; the Elysium on Geary Street, near Jones, and the Dorchester Hotel at Sutter and Gough Streets.³⁵ Aronson was especially busy after the 1906 Earthquake, and was one of San Francisco's most prolific commercial builders by 1916. His other development projects included a building at the corner of 3rd and Jessie streets.

Hemenway & Miller

Hemenway & Miller is a little-known architectural firm that designed several significant buildings in San Francisco during the first decade of the twentieth century. Comprised of architects Sylvester W. Hemenway and Washington J. Miller, the firm was responsible for several prominent pre-quake commercial buildings in downtown San Francisco.

³⁴ Knapp Architects, Property History: 3.

³⁵ "Some Winners in San Francisco Real Estate," *The San Francisco Call* (15 April 1906) 13.

Not much is known about the training of either Hemenway or Miller. Neither individual appears to have attended the École des Beaux-Arts like many of their contemporaries. Both seem to have learned their professions by apprenticing as draftsmen in local San Francisco firms. For example, Hemenway was an apprentice in the office of Wright and Sanders in 1885. The first listing of Sylvester W. Hemenway as an architect occurs in the 1890 San Francisco City Directory. He appears to have been self-employed from 1890 to 1891, but joined the office of Pissis and Moore in 1892 and then the office of A.C. Schweinfurth in 1897.³⁶ Hemenway appears again in the 1899 City Directory as a self-employed architect.³⁷ Meanwhile, Miller was born in 1869 in California, and resided in Oakland by 1903 with his wife, Mary. He was trained as a structural engineer.

In 1900, Hemenway partnered with Washington J. Miller and from 1900 and 1905, the firm was listed in the City Directories as Hemenway & Miller. Their offices were located in the Hearst Building at 691-699 Market Street in 1903. Though their partnership was short-lived, they produced several significant projects, including the Aronson Building; the Bullock & Jones Building/French Bank at 108-110 Sutter Street (1902 and 1907); the Italian Swiss Colony Warehouse at 1265 Battery Street (1903) and the Cargo West Building on Battery Street (both now incorporated as part of Levis Plaza); the Hotel Regent at 562-70 Sutter Street (1907); the Hotel Rex at 230-240 3rd Street (1906; demolished); 53-61 3rd Street (1906; demolished); the Hotel West at 152-162 3rd Street (1906; demolished); 900 Minnesota (1906); 146 Geary Street (1906); 251 Grant Street (1906); and 507 Bush Street (1906). The Aronson and Bullock & Jones Buildings made use of ornamental details reminiscent of the work of famed Chicago School architect Louis Sullivan. In fact, the Aronson Building is often regarded as being the best example of a Chicago School style skyscraper in San Francisco.³⁸ Following the 1906 Earthquake, Hemenway & Miller were retained to rehabilitate the Aronson, Bullock & Jones Buildings, and the Alexander Hotel.³⁹

Abraham Aronson collaborated with Hemenway & Miller on several of his projects. For example, Hemenway & Miller designed a five-story warehouse for Aronson on the northeast corner of Mission and New Anthony streets in 1901 (**Figure 22**), and following construction of the building at 3rd and Mission streets, Aronson commissioned the firm to design a building on Prosper Street, near 16th Street.⁴⁰

³⁶ Knapp Architects, Property History: 4.

³⁷ “Mother Seeks to Restrain Son,” *San Francisco Call* (December 30, 1909), p. 10.

³⁸ Charles Hall Page & Associates and the Foundation for San Francisco’s Architectural Heritage, *Splendid Survivors* (San Francisco: Modern Living Books, 1978), various pages.

³⁹ “Down-town Owner Holds to Old Price,” *The San Francisco Chronicle* (17 May 1906) 9.

⁴⁰ Knapp Architects, Property History: 4.

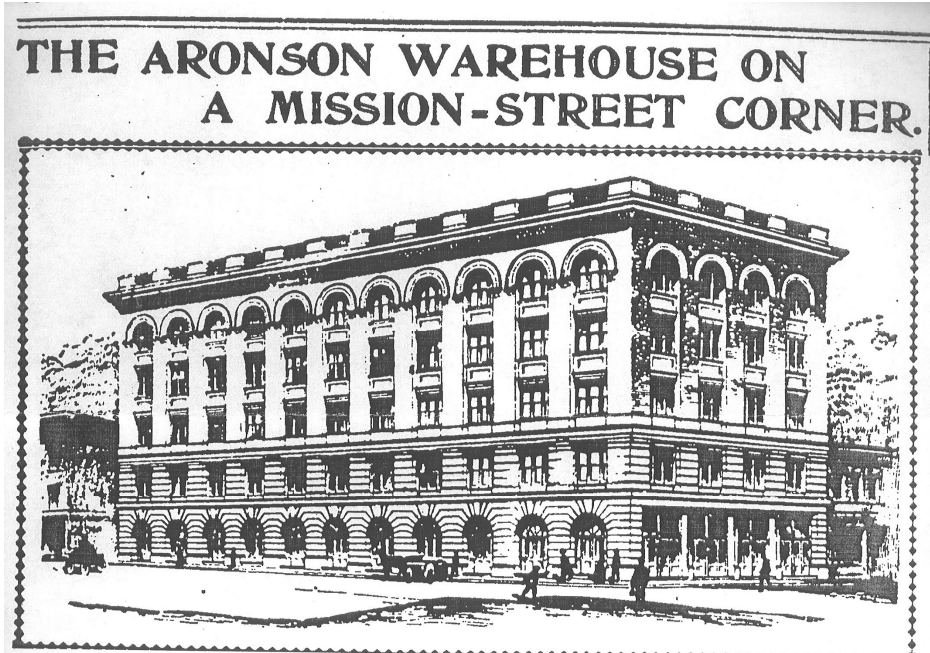

Figure 22. Warehouse at 3rd and Mission, designed by Hemenway & Miller for Aronson, 1901.
Source: "Aronson Warehouse on a Mission-Street Corner," *San Francisco Chronicle* (19 May 1901) 22.

Between 1906 and 1907, the partnership of Hemenway & Miller dissolved and Hemenway was again listed in the San Francisco City Directory as a solo practitioner. By 1909, Hemenway's short career as a self-employed architect succumbed to alcohol addiction and family troubles,⁴¹ though he was employed by the San Francisco Department of Public Works from 1910 to 1911. Miller continued to practice on his own from 1907 until 1925. Despite the short duration of their partnership, Hemenway & Miller executed a handful of significant buildings, several of which are survivors of the 1906 Earthquake and Fire.

Materials Providers

Gladding, McBean & Co.

Gladding, McBean & Co. produced the terra cotta ornament that adorns the upper parts of the Aronson Building's facades. According to the *Supplemental Information Form for Historic Resource Evaluation* by Knapp Architects,

In the fall of 1874, Charles Gladding of Chicago traveled to Lincoln, California and took samples of the clay and sent them back to Chicago for testing by ceramic experts. The results surpassed his expectations. On May 12, 1875, along with new partners Peter McGill McBean and George Chambers, Charles Gladding returned to Lincoln with a group of skilled craftsmen and Gladding, McBean and Co. was born. Soon, Gladding, McBean [and Co.] began shipping clay sewer pipe to towns throughout the state of California.

In 1884, the company built a two-story office building on Market Street in San Francisco, using terra cotta trim made at the Lincoln plant. The building attracted a lot of attention and in the ensuing years, Gladding McBean and Company became a leader in producing architectural terra cotta facades for some of the most significant historical landmarks in San Francisco.

⁴¹ Charles Hall Page & Associates and the Foundation for San Francisco's Architectural Heritage, *Splendid Survivors*.

By the early 1890s, the company had expanded its line to include fire brick, roof tile, chimney pipes, and ornamental garden pottery. An early clay roof tile project was Stanford University, which is an ongoing client relationship.

Gladding, McBean and Co. operated until 1962, when it merged with Lock Joint Pipe Co. and formed what was known as Interpace Corporation. However, in 1976, Interpace announced their intention to cease operations at the Lincoln plant. After so many years, no one ever expected to lose “the Pottery.” At this crucial time, Pacific Coast Building Products emerged to purchase the company and restore the name of Gladding, McBean.⁴²

Vulcan Iron Works

The Vulcan Iron Works of San Francisco, California, produced the cast iron pilasters that divide the bays of the ground floor storefront facades. The Vulcan Iron Works was established in 1851 by George Gordon, who also established the West Coast’s first sugar refinery and developed the South Park residential enclave in the South of Market district. Gordon partnered with E.T. Steen for the iron works. Their main products included steam engines, boilers, sawmills, and mining machinery. The business was located at Kearny and Francisco streets, and continued operations until the late 1920s.⁴³

⁴² Knapp Architects, Property History: 4-5.

⁴³ Knapp Architects, Property History: 5.

B. CHRONOLOGY OF DEVELOPMENT AND USE

Physical construction and modification are summarized in this section. The text is based on building permits, historic documents, and a list of previously documented alterations by Knapp Architects, with corroboration from first-hand observation and materials analysis. Historical photographs and drawings illustrating construction history of the building are included in the section **“Historical Background and Context.”**

1900s

1903: Aronson Building constructed at a total cost of \$700,000, including the land, which cost \$290,000. The building was named after Abraham Aronson, the project’s real estate developer.⁴⁴ Designed by the architecture firm of Hemenway & Miller.

28 December 1906: Building permit issued for the rehabilitation and reconstruction of the Aronson Building, for an estimated cost of \$10,000. The building was used as lofts. The owner was A. Aronson and the architects for the project were Hemenway & Miller (Permit #71101).

1907: Alteration of storefront for cigar store.

1909: Install show window; alter stair to 7th floor.

1910s

1919: Remodel former cigar store and saloon at the corner of 3rd and Mission streets to another use.

1920s

1920: Combine two stores at 702 Mission Street; remove plate glass on Mission Street.

1921: Alter storefront at 708 Mission Street; Move front door at 700 Mission Street.

1930s

1930: Install sidewalk lights; Install storefront, partitions, and other alterations.

1934: Alteration for barber shop at 708 Mission Street.

1936: Remove concrete arches.

1940s

1943: Install pole sign for barber shop at 700 Mission Street.

1946: Sign for Taylor, Army & Navy at 702 Mission Street.

1950s

1954: Remove gates and install concrete bulkhead.

1959: Sign for Pepsi-Cola for Bed’s Coffee Shop at 702 Mission Street.

1960s

1961: Sign installed.

1962: Alterations for Dinty’s Kitchen at 702 Mission Street.

⁴⁴ “Third and Mission Street Structure,” *The San Francisco Chronicle* (28 December 1902) 12.

28 July 1964: Building permit approved for alteration of the ground floor consisting of several small stores. Except for a camera shop still under lease, all the partitions were to be removed and made into one larger store with a mezzanine [for Rochester Clothing Co.] and another smaller store on 3rd Street. All existing show windows were to be removed and replaced, all new electrical wires and fixtures, new exhaust and ventilating system, new baseboard steam connectors, store fixtures, signs, awnings, were not part of this contract. Estimated cost for the project was \$50,000, and the architect for the project was Wayne Osaki (Permit #269932).

1964: Awning for Rochester Clothing Co; Install kitchen and toilet for the Fox Sandwich Shop.

1968: Add mezzanine floor for Rochester Clothing; Install sheetrock at 706 Mission Street.

1970s

24 November 1978: Construct two additions: a ten-story addition on the southwest façade and a three-story addition on the northwest façade. The estimated cost for the project was \$1,500,000 (Permit #332753).

1978-1981: Convert 86 3rd Street lobby to a freight elevator lobby; Move core functions to new southwest addition; Install a full-height interior stair at the west corner of the building; remove and replace nearly all interior finishes; remove entrance on Mission Street and replace with storefront window; remove stone details at 86 3rd Street entrance and cover with brick tiles.

1979: Brick failure analysis.

1980s

1980: Install fixtures for Rochester Clothing Co.

1981: Alterations to walls and ceiling at 700 Mission Street; Install sign for Rochester Clothing Co.; Install glass doors at the elevator lobby.

1983: Life safety; Install rack system in Rochester Clothing Co.

1986: Tenant improvements to 4th through 10th floors; Install toilets in the basement, 8th, 9th, and 10th floors.

2 February 1987: Building permit approved to install new partitions to second floor as part of tenant improvements. Estimated cost for the project was \$150,000 and the designer was Clarke Design Group (Permit #563118).

1987: Remodel/tenant improvements to third floor of 706 Mission Street.

1990s

1993: Install sprinklers for bookstore on ground floor and café on second floor.

1994: Tenant improvements.

1995: Install fire sprinkler system; several tenant improvements.

8 April 1996: Building permit approved to provide a 2-hour fire rated enclosure per plan, revise to #9516998. Estimated cost for the project was \$3,000. The project was complete on 19 August 1996 (Permit Application #9605925).

11 March 1998: Building permit approved to replace brick on the northwest corner of the building. Estimated cost for the project was \$8,000, and the project was complete on 26 August 1998 (Permit Application #9804115).

2000s

February 2006: Stabilization of terra cotta elements at the exterior. Work completed by Rainbow Waterproofing.

2010s

11 February 2010: Building permit approved to remodel the existing 9th floor tenant space by removing private office partitions for new open office area, installing new finishes, and relocating 33 existing light fixtures and adding one new fixture. The estimated cost for the project is \$25,000, and the project is currently in process (Permit Application #201002045899).

17 February 2010: Building permit approved to relocate fire sprinklers on 10th floor. Estimated cost for the project is \$3,000, and the project is currently in process (Permit Application #201002176638).

22 February 2010: Building Permit approved to relocate and add fire alarm system devices on the 9th floor. Estimated cost for the project is \$4,500, and the project is currently in process (Permit Application #201002176664).

Unknown date

All of the common brick, both on the exterior and where exposed on the interior, has been sandblasted.

Windows inserted into the 8th through 10th floors of the northwest façade.

3rd Street doors replaced and metal gate installed.

Open metal fire escapes added to the center bay of the southeast façade and the north end of the northeast façade; projecting terracotta and stone have been removed where the fire escapes are located.

Fixed bronze-anodized aluminum mullion windows replaced the operable pivot wood-sash windows that were installed in the 1906 rehabilitation

Storefront infilled.

C. PHYSICAL DESCRIPTION

Architectural Description

Site

The Aronson Building (Assessor's Parcel Number 3706-093) is located on a 147' x 105.167' rectangular lot at the northwest corner of Mission and 3rd streets, in the South of Market neighborhood of San Francisco, California. The southeast façade is addressed 700-710 Mission Street, while the northeast façade is addressed 86 3rd Street. The rectangular-plan building is flush with the property line on the northeast and southeast sides, and set back from the property line on the northwest and southwest sides. The site slopes very slightly from northwest to southeast.



Figure 23. Aerial view of Aronson Building and surrounding context.

(Source: Microsoft Corporation map, 2010).



Figure 24. Southeast (Mission Street) façade and northeast (3rd Street) façade.

Source: Page & Turnbull, March 2010.

The building is located in a high-rise commercial district, and is surrounded by an outdoor courtyard and the Westin San Francisco Market Street Hotel (50 3rd Street, 1983) to the northwest on the same side of 3rd Street; the Paramount Building (6800 Mission Street, 2002) to the northeast across 3rd Street; the Williams Building/St. Regis Hotel (125 3rd Street, 1907/2005) to the east across the intersection; and the Yerba Buena Center for the Arts to the southeast across Mission Street. The Jessie Square Garage is located to the southwest on the same side of Mission Street, with St. Patrick's Church (748 Mission Street, 1872) southwest of the garage and the Contemporary Jewish Museum (736 Mission Street, 2008, with façade from Jessie Street Substation, 1907) northwest of the garage.

Exterior

Built in 1903 and rehabilitated in 1906 following the earthquake and fire, the Aronson Building is a ten-story over basement, steel-frame commercial building designed in the Chicago School style with Classical Revival ornament (**Figure 24**). The basement extends under the sidewalk on both Mission and 3rd streets. The building sits on a concrete foundation and is clad in dark tile, buff colored brick tile veneer, Colusa sandstone, buff colored glazed terra cotta brick, cast iron, and galvanized steel. The building terminates in a parapet and a flat roof featuring two penthouses (one for the freight

elevator and another for the stair), HVAC equipment to the west, cellular phone antennas at the roof's edges, and a wood flag pole at the east corner. The building's Chicago School three-part horizontal composition, reminiscent of a classical column, features a three-story base, a shaft that rises from the fourth to the eighth floor, and a capital that occupies the ninth and tenth stories.

A three-story addition is located on the northwest façade, and contains a loading dock for the ground floor with office space above. It is independently accessed by the 86 3rd Street entrance. A ten-story, full-width addition is located on the southwest façade, and contains two elevators in an elevator lobby, toilet rooms, and stairway. Both are clad in buff colored brick tile veneer, and both feature flat roofs.

Southeast Facade

The southeast façade of the Aronson Building faces Mission Street, and the original building features five structural bays. The base section of the building's composition includes the first through third stories (**Figure 25**). A modern watertable clad in dark vertical tile runs the length of the second through sixth bays, and the bays are divided by cast iron Ionic pilasters (one features a small plaque on the plinth, which notes "Vulcan Iron Works San Francisco"). The ground floor is clad in non-original buff colored brick tile veneer. The original primary entrance is located in the southwest half of the first bay, and contains a fixed plate glass window with a bronze-anodized extruded-aluminum frame. The former entrance is distinguished by slightly projecting pilasters. The second through fourth bays contain fixed plate glass windows of the same framing material under fabric awnings. The fifth bay, at the corner of Mission and 3rd streets, features a fixed plate glass window; a corner pier clad in dark vertical modern tile; a recessed, angled entry vestibule with fixed plate glass windows and fully glazed, bronze anodized extruded aluminum double doors; and projecting letters that "Rochester Big & Tall." The ground floor terminates in an intermediate entablature with a paneled cast-iron frieze. The street names are incised into the frieze at the northeast end, above the tiled corner pier. The second story features a tripartite arrangement of fixed aluminum-sash windows in each bay, with narrow, bracketed cast iron pilasters between windows and Ionic pilasters between bays. The first bay to the southwest, above the original entrance, features a sandstone balustrade and bracketed cast-iron cornice with modillions around a fixed window. The second story terminates in a larger sandstone entablature with an unadorned frieze. The third story features pairs of bronze anodized extruded-aluminum sash windows in each bay. The windows are divided by Ionic pilasters, and the pairs are separated by horizontally rusticated sandstone piers. The third story terminates in a sandstone entablature.



Figure 25. First through third stories, southeast (Mission Street) façade.
Source: Page & Turnbull, March 2010.

The fourth through eighth stories make up the middle section, or shaft, of the building. These stories are clad in buff colored glazed terra cotta brick and feature paired bronze-anodized extruded-aluminum sash windows in each bay. The windows feature horizontal mullions three-quarters up. The windows are divided by brick Ionic pilasters with sandstone capitals, and the bays are divided by giant-order brick Corinthian pilasters. The capitals include acanthus leaves under a smaller molding of water leaves. The floors are separated by brick spandrel panels and window sills and headers of terra cotta tile. These horizontal elements recede behind the front plane of the pilasters to emphasize the verticality of the pilasters and reinforce the vertical expression of the building shaft.

The ninth and tenth floors form the ornamented capital of the building's composition, and are clad in terra cotta (**Figure 26**). The ninth floor features pairs of fixed windows within an arcade of molded arches that spring from the Corinthian capitals below. The arches feature keystones (some partially or fully removed) and egg-and-dart molding. Bas reliefs featuring cartouches, scrolls, and olive leaves ornament the spandrels, and brick Ionic pilasters divide the windows within the arches. The ninth floor terminates in a banded bay leaf garland molding. The tenth floor features pairs of fixed windows like those of the lower floors, divided by brick pilasters. Wall panels and oval egg-and-dart moldings separate each bay. The primary façade terminates in a massive entablature with a frieze of egg-and-dart molding and oculi framed in olive leaf swags; large egg-and-dart molding; pairs of scrolled brackets above molded swags and consoles; block modillions; and a cornice. The brackets, modillions, and cornice are made of galvanized sheet steel that is painted (the originals were copper).



Figure 26. Ninth and tenth stories, southeast (Mission Street) façade.
Source: Page & Turnbull, March 2010.

Non-original, metal fire escape balconies are located in the center structural bay of each story.

The southeast façade of the southwest addition is a blank brick wall that extends the full ten stories.

Northeast Facade

The northeast façade faces 3rd Street, and features four structural bays (**Figure 27**). The organization, fenestration, and ornament are identical to that on the primary façade. The capitals of the Ionic

pilasters on the ground floor are missing. The original primary entrance of this façade is located in the fourth bay at the north end. Paneled wood double doors and an arched glazed transom are recessed within an arched entryway, which is clad in buff colored brick tile veneer. The bronze door frame and transom frame are original and display a chain band pattern on the face of the frame. A cast iron gate is located in front of the entryway. A non-original metal fire escape is located in the northern-most bay.



Figure 27. Northeast (3rd Street) façade.
Source: Page & Turnbull, March 2010.



Figure 28. Northwest and southwest façades.
Source: Page & Turnbull, March 2010.

A three-story addition on the northwest side of the building is clad in buff colored brick tile veneer. The northeast façade has a roll-up metal garage door set within an arched opening. The façade terminates at the third story with an ornamental cornice of pre-cast concrete.

Northwest Facade

The northwest façade of the original building is clad in common red brick, and has bronze anodized aluminum-sash windows that are inserted in random locations at the eighth through tenth stories (**Figure 28**). Two segmental arch openings have been infilled at the seventh and eighth stories, and another was re-used for a smaller window at the tenth story.

On the northwest façade of the three-story addition, two two-story high windows with pre-cast concrete frames and wall panels span the second and third stories, and terminate in arched windows (**Figure 29**).



**Figure 29. Northeast façade, three-story addition.
Source: Page & Turnbull, March 2010.**

The northwest façade of the southwest addition features pairs of fixed, bronze-anodized extruded-aluminum sash windows at the second through tenth stories, and terminates in a concrete cornice.

Southwest Facade

The southwest façade of the original building is obscured by the southwest addition (**Figure 28**). The addition's southwest façade features an offset primary entrance for the upstairs offices (**Figures 30 and 31**). It is accessed at the south corner of the parcel on Mission Street through a metal fence and gate, which is capped by a wood trellis. Two two-headed light standards flank the gate entrance. A concrete walkway leads to two entryways, which are located under projecting vaulted canopies of smoked acrylic and metal. Single-head versions of the light standards, which were created in 1917 for use along the Embarcadero and on trolley wiring poles, are mounted on the canopy supports. Glazed double doors with bronze anodized aluminum frames are located under the first canopy. The doors are framed by a metal storefront system of clear glazing on each side and an arched transom above. A similar entrance with solid double doors is located to the northwest, and another pair of two-headed light standards near the end of the walkway. A metal fence with a gate at the northwest corner of the property leads to a driveway. Above the primary entrance, a single bay of paired bronze-anodized extruded-aluminum sash windows rises from the second through the eighth floors. They are set within a pre-cast concrete frame, and topped with arched windows. The windows are separated horizontally by precast wall panels.



Figure 30. Southwest façade, walkway and entrance canopies.

Source: Page & Turnbull, March 2010.



Figure 31. Southwest façade, primary entrance.

Source: Page & Turnbull, March 2010.

The southwest façade of the northwest addition features a large arched opening with a roll-up metal garage door at the ground floor, and cantilevered concrete slab balconies at the second and third stories that are enclosed by metal railings.

Interior

The interior retains few original features, and has been altered to modern retail and office spaces. The basement includes brick walls and steel columns encased in terra cotta and concrete (**Figure 32**).

Original patterned ceramic mosaic tile flooring is located inside the 3rd Street entrance, and continues into the freight elevator lobby, which used to be the building's primary elevator core and stair (**Figure 33**). A red-brown field border with white tile is laid out in a Greek key fretwork pattern. The center of the flooring features white octagonal-shaped tiles inset with red-brown square tiles set on the diagonal.

Aside from the section of tile flooring, and historic window trim on the upper floors, the interior does not retain any historic finishes. It includes plaster drywall partitions, modern wood laminate flooring on the ground floor, carpeting over concrete on floors two through ten, modern flush wood or metal doors, and drop acoustic tile ceiling grids with florescent lights. The office floors typically are open floor plans at the center, with built out office space and conference rooms around the perimeter (**Figure 34**).

Please see **Section F. Condition Assessment** for further description of materials conditions.



Figure 32. Column encased with terra cotta tile.
Source: Page & Turnbull, March 2010.



Figure 33. Mosaic tile floor at 3rd Street lobby.
Source: Page & Turnbull, March 2010.



Figure 34. Typical interior office floor (4th floor).
Source: Page & Turnbull, March 2010.

Character-Defining Features

For a property to be individually eligible for national or state designation under criteria related to type, period, or method of construction, the essential physical features (or character-defining features) that enable the property to convey its historic identity must be evident. These distinctive character-defining features are the physical traits that commonly recur in property types and/or architectural styles. To be eligible, a property must clearly contain enough of those characteristics to be considered a true representative of a particular type, period, or method of construction, and these features must also retain a sufficient degree of integrity. Characteristics can be expressed in terms such as form, proportion, structure, plan, style, or materials.

The character-defining features of the Aronson Building include:

Structure:

- Steel structure with columns encased in terra cotta and concrete
- Concrete floor plates

Exterior:

- Historic building's form, shape, height, and massing;
- Flat roof;
- Tripartite Chicago School composition of base, shaft, and capital;
- Wall cladding of buff colored glazed terra cotta brick;
- Fenestration pattern;
- Historic entrance openings and their ornament on Mission and 3rd Street;
- Cast iron and sandstone pilasters at the first and second stories of the Mission and 3rd Street facades;
- Sandstone intermediate entablatures on the Mission and 3rd Street facades;
- Rusticated sandstone piers at the third story of the Mission and 3rd Street facades;
- Giant order buff colored terra cotta brick pilasters with terra cotta capitals at the fourth through eighth stories of the Mission and 3rd Street facades;
- Terra cotta brick wall panels and terra cotta window sills and headers at the fourth through eighth stories;
- Terra cotta ornament at the ninth and tenth stories, including archivolt moldings, remaining keystones, egg-and-dart molding, spandrel bas relief ornament, banded bay leaf garland, pilasters, wall panels, and olive leaf swags;
- Massive galvanized sheet steel entablature with paired scrolled brackets, block modillions, and cornice;
- Common brick wall cladding on the northwest and original southwest façades.
- Wood flagpole at west corner of the roof.

Interior:

- Wood window trim and sills

Character-Defining Features: Individual Significance vs. Historic District Significance

Character-defining features allow the building to convey its individual significance. In the case of the Aronson Building, they contribute to the building's Chicago School style and the structural features that allowed the building to survive the 1906 earthquake and fire.

By embodying these same character-defining features, the building is also able to contribute to the significance of the Aronson Historic District, which is significant for its "City Beautiful" commercial block architecture built immediately after the 1906 earthquake (See **D. Evaluation of Significance** for more information). A detailed discussion of the building's contribution to the Historic District is beyond the scope of this report.

D. EVALUATION OF SIGNIFICANCE

National Register of Historic Places

The National Register of Historic Places is the nation's most comprehensive inventory of historic resources. The National Register is administered by the National Park Service and includes buildings, structures, sites, objects, and districts that possess historic, architectural, engineering, archaeological, or cultural significance at the national, state, or local level. Typically, resources over fifty years of age are eligible for listing in the National Register if they meet any one of the four criteria of significance and if they sufficiently retain historic integrity. However, resources under fifty years of age can be determined eligible if it can be demonstrated that they are of "exceptional importance," or if they are contributors to a potential historic district. National Register criteria are defined in depth in *National Register Bulletin Number 15: How to Apply the National Register Criteria for Evaluation*. There are four basic criteria under which a structure, site, building, district, or object can be considered eligible for listing in the National Register. These criteria are:

Criterion A (Event): Properties associated with events that have made a significant contribution to the broad patterns of our history;

Criterion B (Person): Properties associated with the lives of persons significant in our past;

Criterion C (Design/Construction): Properties that embody the distinctive characteristics of a type, period, or method of construction, or that represent the work of a master, or that possess high artistic values, or that represent a significant distinguishable entity whose components lack individual distinction; and

Criterion D (Information Potential): Properties that have yielded, or may be likely to yield, information important in prehistory or history.

A resource can be considered significant on a national, state, or local level to American history, architecture, archaeology, engineering, and culture.

California Register of Historical Resources

The California Register of Historical Resources (California Register) is an inventory of significant architectural, archaeological and historical resources in the State of California. Resources can be listed in the California Register through a number of methods. State Historical Landmarks and National Register-eligible properties are automatically listed on the California Register.⁴⁵ Properties can also be nominated to the California Register by local governments, private organizations or citizens. This includes properties identified in historical resource surveys with Status Codes of 1 to 5, and resources designated as local landmarks through city or county ordinances. The evaluative criteria used by the California Register for determining eligibility are closely based on those developed for use by the National Park Service for the National Register. In order for a property to be eligible for listing in the California Register, it must be found significant under one or more of the following criteria:

Criterion 1 (Event): Resources that are associated with events that have made a significant contribution to the broad patterns of local or regional history, or the cultural heritage of California or the United States.

⁴⁵ National Register-eligible properties include properties that have been listed on the National Register, and properties that have formally been found eligible for listing.

Criterion 2 (Persons): Resources that are associated with the lives of persons important to local, California, or national history.

Criterion 3 (Architecture & Design): Resources that embody the distinctive characteristics of a type, period, region, or method of construction, or represent the work of a master, or possess high artistic values.

Criterion 4 (Information Potential): Resources or sites that have yielded or have the potential to yield information important to the prehistory or history of the local area, California or the nation.

As part of an Environmental Impact Statement conducted by the Department of Housing and Urban Development (HUD) of the Yerba Buena Center redevelopment area in 1978, the Aronson Building was evaluated for its historic significance. HUD and the State Historic Preservation Officer (SHPO) determined the building eligible for the National Register of Historic Places as an individual resource and as a contributing resource to the Aronson Historic District. As a property that is eligible for the National Register, it was automatically listed on the California Register. The building and Historic District were listed for their significance under Criterion C/3 (Design/Construction).

Page & Turnbull did not evaluate the Aronson Building for its significance. Below is a summary of the evaluation included in the 1978 *Determination of Eligibility*.

Criterion A/1 (Events)

The Aronson Building was not determined eligible for listing in the National Register, nor listed in the California Register, under this Criterion in 1978.

Criterion B/2 (Persons)

The Aronson Building was not determined eligible for listing in the National Register, nor listed in the California Register, under this Criterion in 1978.

Criterion C/3 (Design/Construction)

The Aronson Building was determined eligible for listing in the National Register and listed in the California Register in 1978 under Criterion C/3 (Design/Construction). The three contributing resources to the Aronson Historic District—the Aronson/Mercantile Building (1903; rehabilitated 1906), Williams Building (1907), and Rosenthal/Grace Building (1907)—were recognized for their “City Beautiful’ commercial block architecture popular in early 20th century.”⁴⁶ When the buildings were documented in a *Determination of Eligibility Notification for the National Register of Historic Places* in 1978, they were part of the Yerba Buena Center redevelopment area. They stood as a solitary cluster of extant high-rise reinforced masonry buildings that were constructed before and immediately following the 1906 Earthquake, and thus, were recognized for being “significant as a group, preserving a whole commercial corner essentially as it was originally.”⁴⁷

Individually, the Aronson Building was recognized as possessing the most representative and elaborate design in the Chicago School style in San Francisco. According to the *Determination of Eligibility Notification*, the Aronson Building “...is individually eligible for its design which is reminiscent of Louis Sullivan’s skyscrapers in Chicago.”⁴⁸

⁴⁶ Tad Masaoka, HUD, E.O.11593: *Determination of Eligibility Notification for the National Register of Historic Places, Office of Archeology and Historic Preservation* (27 March 1978).

⁴⁷ Ibid.

⁴⁸ Ibid.

Criterion D/4 (Information Potential)

The Aronson Building was not determined eligible for listing in the National Register, nor listed in the California Register, under this Criterion in 1978.

Period of Significance

The *Determination of Eligibility Notification for the National Register of Historic Places* (1978) does not establish a period of significance for the Aronson Historic District. Based upon the information provided in the Determination of Eligibility, Page & Turnbull has determined a period of significance for the Aronson Building as part of the Aronson Historic District from 1903-1907, the period in which the three contributing buildings were constructed.

As an individual resource, the period of significance for the Aronson Building is 1903-1906, the period that encompasses the building's initial construction, survival through the 1906 Earthquake and Fire, and rehabilitation following the disaster.

E. SIGNIFICANCE DIAGRAMS

This section provides an analysis of the relative zones of significance present at the Aronson Building. Utilizing accepted standards for the evaluation of historic resources in addition to the guidelines published by the City of San Francisco, the major historical features have been identified and visually documented within a series of significance diagrams.

The base drawings for the Significance Diagrams were produced by T/W Associates in 1979 for the “Mercantile Center Building, Additions & Rehabilitation.” The drawings are intended only as a background for the Significance Diagrams.

For the purposes of this analysis, Page & Turnbull surveyed the building, including all exterior façades and interior spaces. The façades, spaces and elements were evaluated in terms of their relative contribution to the significance of the building by categorizing them as “Significant,” “Contributing,” or “Non-Contributing.”

It should be noted that features that are considered character-defining (see **Table 1** below) are categorized as “Significant” or “Contributing,” depending on their level of importance in conveying the significance of the building. Character-defining features, if removed, would decrease the building’s historic integrity and its ability to convey its significance. Thus, the categories below divide the character-defining features, and those that are not character-defining, into more specific definitions relating to their individual integrity and importance.

These categories are defined as follows:

Significant

Definition: Spaces, elements or materials characterized by a high degree of architectural significance and a high degree of historic integrity. An example of a significant feature is the tripartite composition of the building.

Preliminary Guideline: Significant exterior and interior features and materials should be retained and preserved, or where alterations have occurred, be restored. Deteriorated materials should be repaired rather than replaced. Where replacement is necessary due to extensive material deterioration or failure, replacement materials should match the original materials and forms.

Contributing

Definition: Elements characterized by a lesser degree of architectural significance, yet retain a high degree of historic integrity, or historically important, yet altered elements. An example of a contributing feature of the building is the steel structural columns (Figure 34).

Preliminary Guideline: Contributing elements should be retained wherever possible, but are not essential to the building’s ability to convey its overall significance. Where required, alterations and additions should be designed to be compatible with the existing elements and materials. New materials and assemblies at reconstructed areas should be similar to the original.

Non-Contributing

Description: Non-Contributing elements are generally non-historic elements or elements that have been altered to the extent that their original character is absent. Examples of historic fabric that are non-contributing include the patterned ceramic mosaic tile flooring at the 86 3rd Street entrance (Figures 33 and 66) and the hollow clay tile at the basement level (Figure 32). The ceramic mosaic tile

is non-contributing because it is a fragment, and portions have been altered. The basement hollow clay tile is non-contributing because it is not architecturally significant.

Preliminary Guideline: Non-Contributing elements are not specifically limited by preservation recommendations, except to note that the overall character of alterations to an historic building must meet the general requirements set forth in the *Secretary of the Interior's Standards for the Treatment of Historic Properties* (Standards). While there are no specific recommendations for the treatment of Non-Contributing spaces, the building's general organization should be retained.

Summary

Exterior: Most of the Aronson Building's significant features are on the exterior of the building. The existing primary facades are much like they were during the building's period of significance. The exterior of the building dates from 1903 to 1907, except for the aluminum-sash windows and storefronts, brick infill at the ground level, and the 1970s additions.

Thus, for example, the exterior walls and ornament on Mission and 3rd streets are "significant," while the northwest and southwest secondary facades of common brick are "contributing." The windows and storefronts on the primary facades, as well as the additions, are "non-contributing."

Interior: The interior of the building has been altered and very little historic fabric remains. Historic features that remain include the steel structural columns, concrete floor slabs, wood trim at windows, and the mosaic tile at the northeast entry. Of these, the columns, concrete floor slabs, and the wood trim at the windows are contributing features. The mosaic tile is non-contributing.

In the Significance Diagrams, the interior of the building is shown as a hatch to denote that the volume of the building's interior contains no significant fabric while the columns and concrete slab of the space are "contributing" features of the structural system.

Table 1. Comparison of Character-Defining Features to Level of Significance

Historic Feature	Character-Defining?	Level of Significance
Structure		
Steel structure with columns encased in terra cotta and concrete	Yes	Contributing
Concrete floor plates	Yes	Contributing
Exterior		
Form, shape, height, massing of original building	Yes	Significant
Flat roof	Yes	Significant
Tripartite composition of base, shaft, and capital	Yes	Significant
Buff colored glazed terra cotta brick	Yes	Significant
Ground floor buff colored brick tile veneer	No	Non-contributing
Fenestration pattern on Mission and 3 rd Street facades	Yes	Significant

Historic Feature	Character-Defining?	Level of Significance
Bronze-anodized extruded-aluminum sash windows	No	Non-contributing
Historic entrance openings and their ornament on Mission and 3rd Street, including bronze door frame and arched transom frame at 3 rd Street entrance	Yes	Significant
Storefront doors and windows	No	Non-contributing
Colusa sandstone intermediate entablatures	Yes	Significant
Rusticated sandstone piers and cast iron divisions at the third story of the Mission and 3 rd Street facades	Yes	Significant
Giant order, buff-colored glazed terra cotta brick pilasters with terra cotta capitals at the fourth through eighth stories of the Mission and 3 rd Street facades	Yes	Significant
Terra cotta brick spandrel panels and terra cotta window sills and headers at the fourth through eighth stories	Yes	Significant
Terra cotta ornament at the ninth and tenth stories, including archivolt moldings, remaining keystones, egg-and-dart molding, spandrel bas relief ornament, banded bay leaf garland, pilasters, wall panels, and olive leaf swags	Yes	Significant
Massive sheet metal entablature with paired scrolled brackets, block modillions, and sheet metal cornice	Yes	Significant
Common red brick masonry wall cladding on the northwest and original southwest façades	Yes	Contributing
Scattered window openings on northeast façade	No	Non-contributing
Wood flagpole at west corner of the roof	Yes	Contributing
Northeast and northwest additions	No	Non-contributing
Interior		
Wood window trim and sills	Yes	Contributing
Interior volume and associated finishes	No	Non-contributing
Patterned ceramic floor tile at 3rd Street entrance lobby	No	Non-contributing
Hollow clay tile at basement level	No	Non-contributing

Notes:

- 1.) "Roebing System B" cinder concrete floor slabs are contributing. (See page 16 for historical description.)
- 2.) Painted metal windows and storefront and brick infill between bays at ground level are non-contributing.

LEGEND

- Significant**
- Contributing**
- Non-contributing**

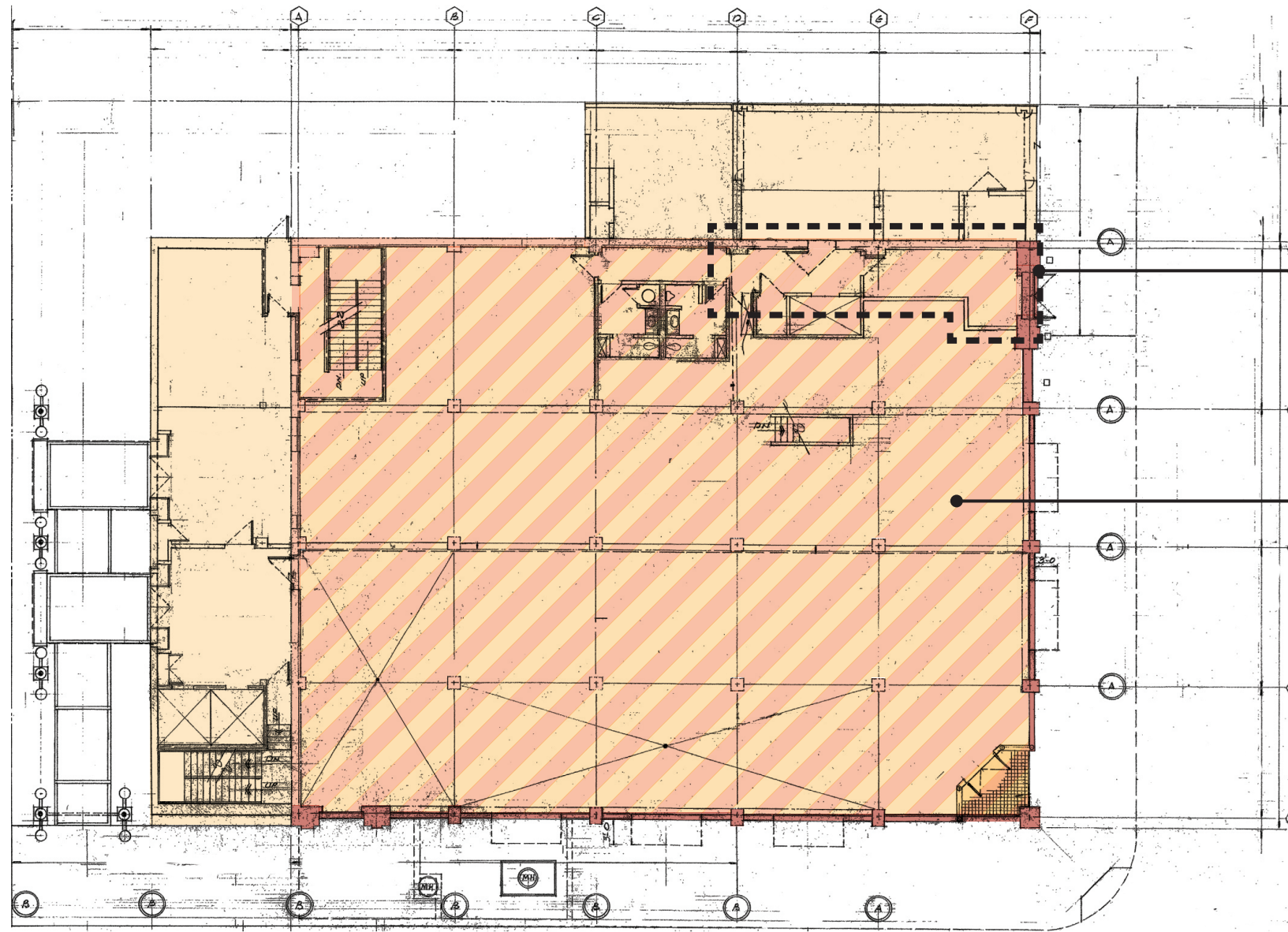

Ceramic mosaic tile floor is non-contributing historic fabric. Although original, it is a fragment and portions have been altered.



Volume and associated finishes are non-contributing, but the concrete floor slabs are contributing. Columns are also contributing.



Notes:

- 1.) "Roebing System B" cinder concrete floor slabs are contributing. (See page 16 for historical description.)
- 2.) Interior wood trim at windows is contributing.
- 3.) Aluminum windows, storefront and brick infill between bays are non-contributing.

LEGEND

-  **Significant**
-  **Contributing**
-  **Non-contributing**

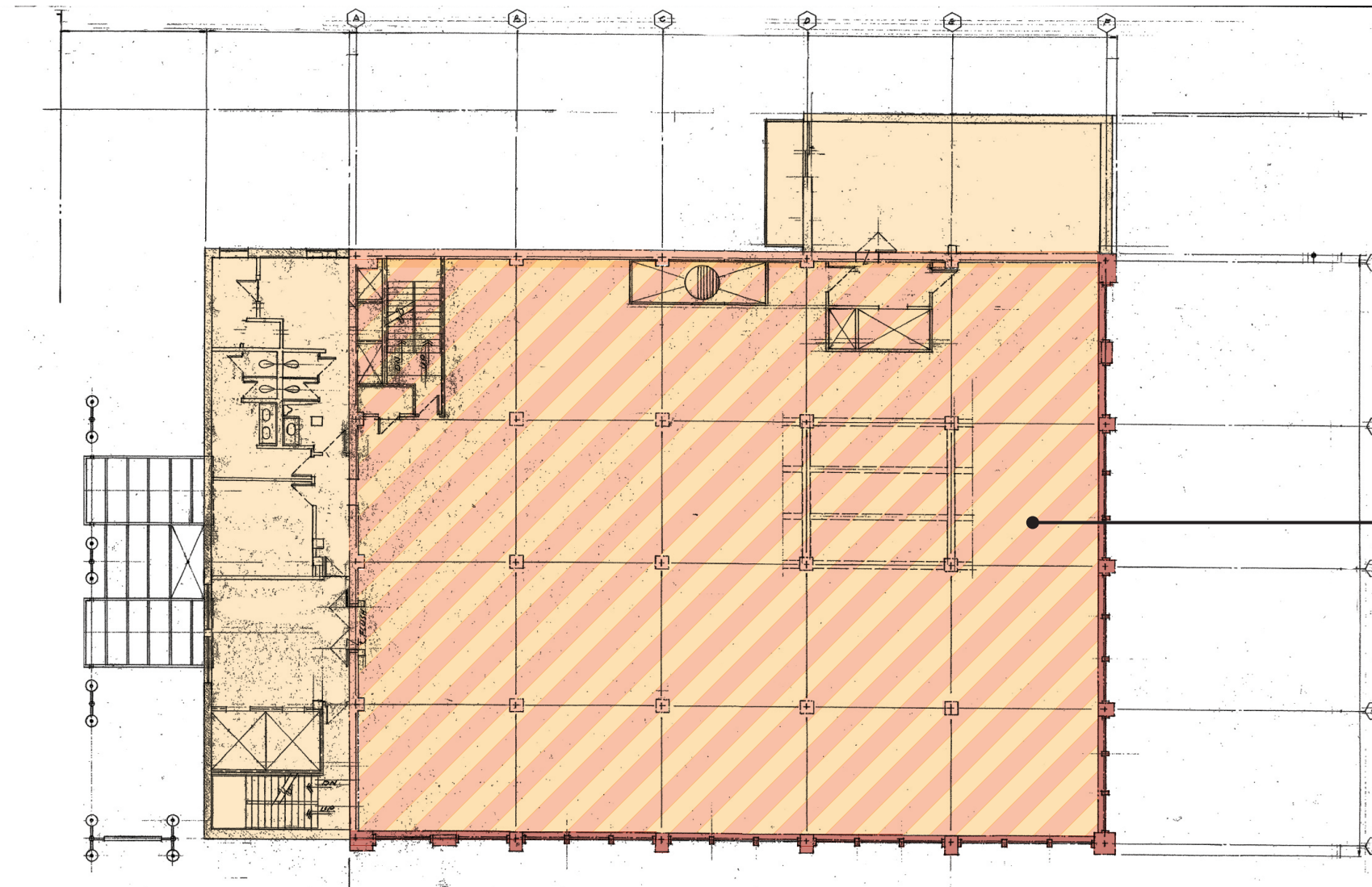

Volume and associated finishes are non-contributing, but the concrete floor slabs are contributing. Columns are also contributing.



Typical Upper Floor Plan (Second - Tenth Floors)

SIGNIFICANCE DIAGRAMS

LEGEND

- Significant
- Contributing
- Non-contributing

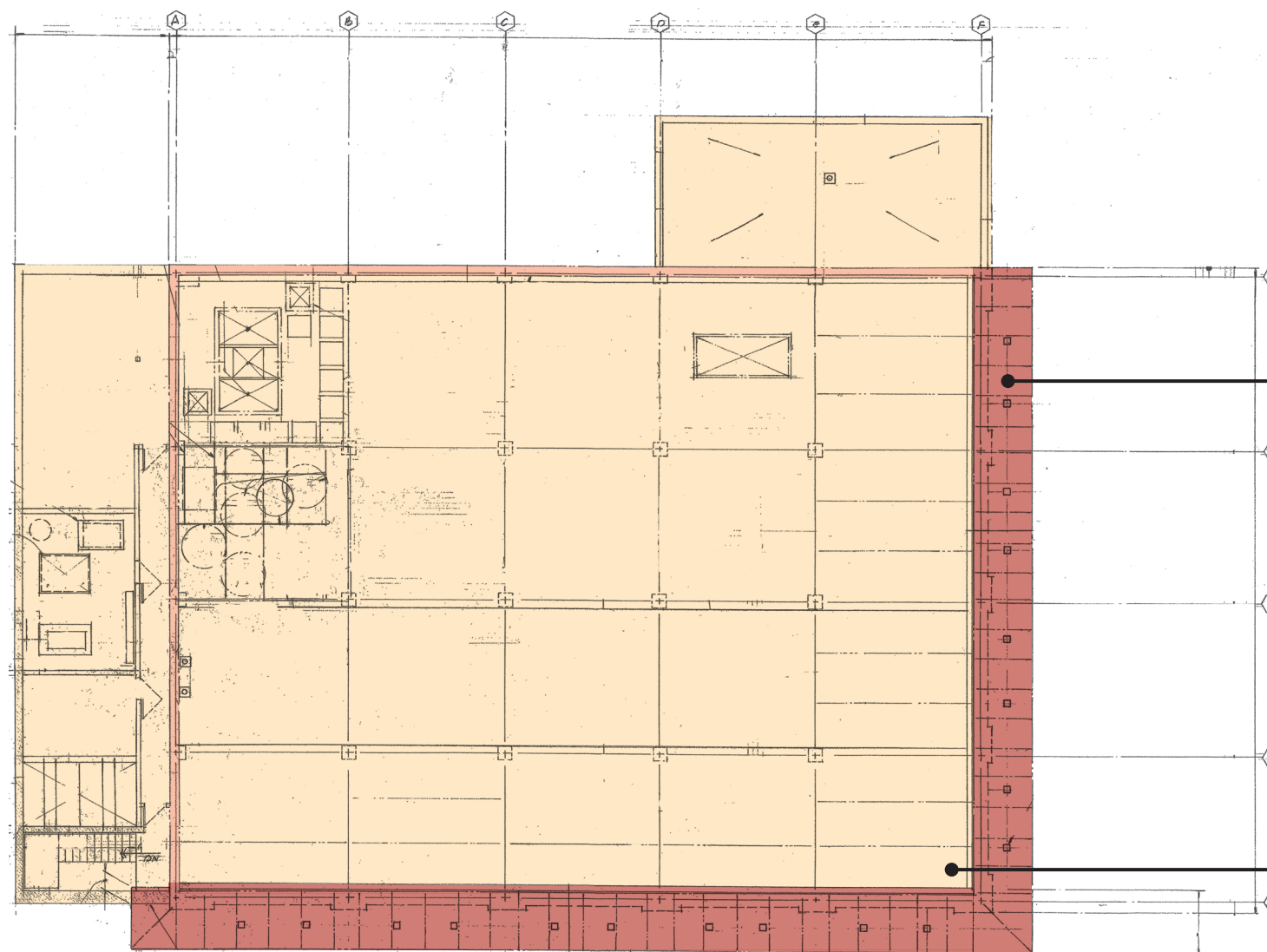



Sheet metal cornice.

Wood flagpole is a contributing character defining feature.



LEGEND

-  Significant
-  Contributing
-  Non-contributing





East Elevation (Third Street)



South Elevation (Mission Street)

LEGEND

-  Significant
-  Contributing
-  Non-contributing

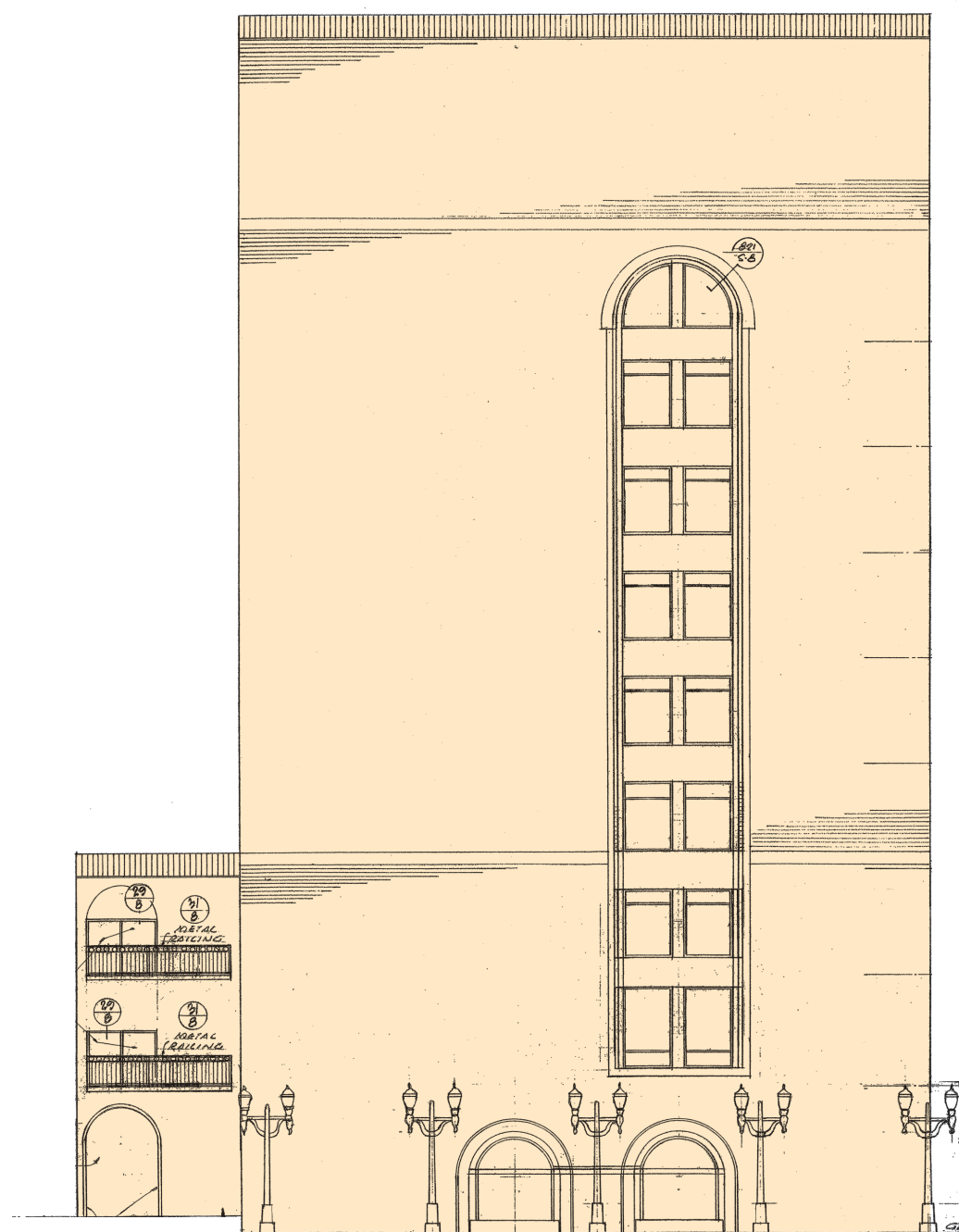

West Elevation



North Elevation

F. CONDITIONS ASSESSMENT

This section records the existing conditions of the building as surveyed in March 2010. Architectural elements of the Aronson Building are categorized by exterior and interior materials and assemblies. Character-defining features (as noted in the Character-Defining Features section) are the primary focus of this assessment.

The purpose of the investigation is to:

- Document and assess the condition of the existing building;
- Identify areas of immediate concern;
- Identify areas where further investigation is required.

Conditions Assessment Methodology

The Aronson Building was visually surveyed during the week of March 1st by architectural conservators and historians from Page & Turnbull. The survey primarily consisted of visual observations of the building's exterior through window openings and through the use of binoculars and telescopes from grade. Photographs were taken of significant architectural features throughout the interior and exterior of the building, and existing conditions data were recorded in field drawings and notes. No hazardous materials testing, including lead paint and asbestos, was conducted.

Lack of access to the exterior limited the level of assessment and prevented further investigation into failing materials and conditions. Additionally, the lack of historic drawings limited the amount of historical information regarding the building's original construction and detailing. Original drawings are likely to have been lost or destroyed over time, which is not uncommon for a building of this age.

Interviews with the maintenance staff as well as a former contractor were conducted and are further discussed within this section. Documentation, in the form of photographs, of a past stabilization project was reviewed. With permission from the contractor, a number of these photographs are included in this section.

Conditions Definitions

The building elements conditions are described on a good, fair, poor rating system, defined as:

Good (G)

The building element / feature is intact, structurally sound, and performing its intended purpose. The component needs no repair or rehabilitation, but only routine or preventative maintenance.

Fair (F)

The building element / feature is in fair condition if either of the following conditions is present:

- a) There are early signs of wear, failure, or deterioration though the component and its features are generally structurally sound and performing their intended purpose; or
- b) There is failure of a feature or component.

Poor (P)

The building element / feature is in poor condition if any of the following conditions is present:

- a) The features are no longer performing their intended purpose; or
- b) Features are missing; or
- c) Deterioration or damage affects more than 25% of the component; or
- d) The component or features show signs of imminent failure or breakdown.

Unknown (U)

The assembly or feature was not accessible for assessment or not enough information is available to make an evaluation.

Summary of Existing Conditions

The condition of the Aronson Building is marked by age, weathering, and impacts from the 1906 earthquake and fire and the 1989 Loma Prieta earthquake. Generally the building is in fair condition. As previously described in the Construction Chronology section, the building has undergone several interior renovations, resulting in removal of most interior finishes and historic fabric. The exterior cladding is in fair-to-poor condition with cracked and spalled terra cotta and sandstone.

Exterior Cladding

The exterior architectural terra cotta, brick and sandstone cladding are identified as areas of immediate concern. All three materials suffer from extensive cracking, spalling and missing units, as further described below. Limited access to the exterior prevented an up-close investigation of these materials.

The primary cause for deterioration is likely due to water infiltration into the cladding system. For terra cotta elements, this may result in corrosion of steel anchoring systems and/or cracking of the unit itself. Sandstone is highly sensitive to high levels of moisture, which can result in the observed exfoliation of layers. This theory cannot be confirmed at this time due to limited access to the building exterior. See the recommendations section for further discussion on an in-depth façade assessment.

Although the primary cause is undetermined, one aspect of deterioration is certain: cracks and spalls left exposed to the elements, as observed, create an avenue for water to infiltrate into the wall system. This condition will likely accelerate the deterioration, potentially resulting in:

- Accelerated rate of deterioration;
- Deterioration/failure of steel anchoring systems, resulting in corrosion, rust jacking and/or attachment failure;
- Deterioration of building structural system;
- Water penetration into the interior of the building, resulting in damage to interior finishes.

The building exterior has undergone several stabilization campaigns, the most recent completed in 2006 after a piece of terra cotta reportedly fell from the building. The 2006 work is further described in the Terra Cotta Existing Conditions section. Although stabilization is necessary when materials become unstable and pose a safety hazard, it is not recommended as a long-term repair. Further investigation is required in order to provide specific long-term repair recommendations. For information on recommendations for these materials refer to the Conservation and Rehabilitation Plan section of this report.

Water Infiltration

Interviews with maintenance staff indicate that no water infiltration into the building has been observed, except at the roof and the basement. Minor leaking at the roof is an ongoing maintenance issue.

Conditions Assessment of Features

Historic architectural elements of the Aronson Building are categorized in the following conditions assessment by exterior and interior materials/assemblies.

Brick (Contributing Character-Defining Feature)

Description and History

The exterior wall at the northwest alley is common red brick masonry, structurally self-supporting. The original southwest wall at the addition remains intact and is exposed at the interior in select areas. This wall is also common red brick masonry, structurally self-supporting. The exterior face brick is coarsely textured, wire-cut red brick. Units measure approximately eight inches wide by two and a half inches tall by four inches deep. Mortar is soft, light grey in color with a joint width of approximately a half inch. The exterior of the northwest alley wall contains ghostings of past signage.

Deterioration Conditions

Survey of the brick was completed from the exterior by use of telescope. Where exposed, the brick at the interior was also surveyed. The brick is in fair condition at the exterior with evidence of abrasive blasting and cracking. Interior face of the brick shows evidence of abrasive blasting. The following are observed conditions:

- Vertical cracking at the northeast corner where the brick wall meets the terra cotta clad 3rd Street façade (**Figure 35**);
- Evidence of abrasive blasting of the brick face at the exterior, confirmed by an annotation in the 1979 construction documents (**Figure 36**);
- Evidence of moisture at roof parapet, as seen by organic growth (**Figure 37**);
- Evidence of abrasive blasting of brick face at the interior, resulting in loss of mortar, pitting of the brick face, and rounded brick edges (**Figure 38**);
- Poor joint condition due to abrasive blasting.

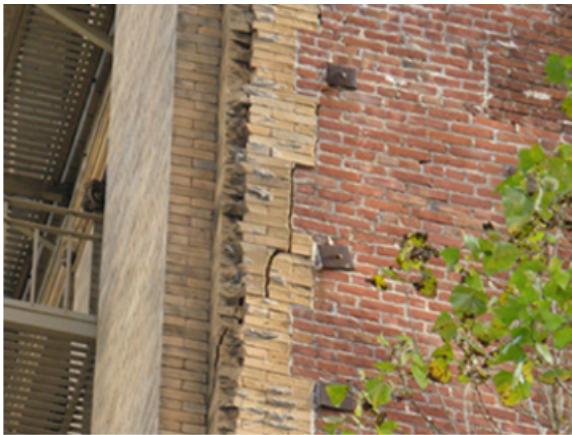

Figure 35. Cracking at terra cotta to brick interface.
Source: Page & Turnbull, March 2010.



Figure 36. Exterior brick face.
Source: Page & Turnbull, March 2010.



Figure 37. Weeds growing out of a parapet wall.
Source: Page & Turnbull, March 2010.



Figure 38. Interior brick face.
Source: Page & Turnbull, March 2010.

Sandstone (Significant Character-Defining Feature)

Description and History

The second and third stories of the Mission Street and 3rd Street façades incorporate Colusa Sandstone, a local stone used in construction of several prominent San Francisco buildings, such as the Ferry Building and the Flood Building. Stone elements include flat ashlar units with a grooved brush-chiseled texture finish, a deep water table that wraps both facades, and horizontal pediment and balustrades over the original entrances, of which the 3rd Street facade is missing its balustrade. The sandstone is painted a dark brown color.

Deterioration Conditions

Survey of the sandstone was conducted by use of a telescope from grade, and also from the interior by looking through the windows. The sandstone is in fair-to-poor condition, suffering from exfoliation, cracking, and spalling. Research into Colusa sandstone found that this type of stone has a tendency to form gypsum crusts and exfoliate (decay), sometimes within the first 20 years of the building's life. Generally considered to be a low-grade building sandstone, Colusa sandstone is moderately soft, porous, and has a high rate of absorption.⁴⁹ The following are observed conditions:

- Cracking of the stone, particularly at the overhang edges (**Figure 39**);
- Corrosion of steel cramps and anchors (**Figure 40**);
- Spalling of edges and corners (**Figure 41**);
- Exfoliation of crust at the top side (horizontal surface) of the stone (**Figure 42**);
- Delaminating paint coating;
- Loss of / missing mortar at joints.

⁴⁹ Searls, Carolyn L., Joshua M. Marro and Ronald L. Mayes. "A Mausoleum on Shaky Ground: de la Montanya Mausoleum, Cypress Lawn, Colma, California." *APT Bulletin Vol. 36, No. 2/3* (2005) : 13-19.



Figure 39. Cracking and spalling of sandstone at edge. Source: Page & Turnbull, March 2010.



Figure 40. Cracking/spalling of concrete at steel corrosion. Source: Page & Turnbull, March 2010.



Figure 41. Spalling of sandstone at edge. Source: Page & Turnbull, March 2010.



Figure 42. Exfoliation of crust. Source: Page & Turnbull, March 2010.

Terra Cotta (Significant Character-Defining Feature)

Description and History

Architectural terra cotta is used for cladding and ornamentation on the Mission Street and 3rd Street facades of the building. Terra cotta features include the column base and capitals, door architrave, and arched window surrounds, all finished with a slip glaze. Additionally, the middle section of the building between the fourth and eighth floors is faced with a buff colored glazed brick. Mortar is of a color that closely matches that of the surrounding terra cotta.

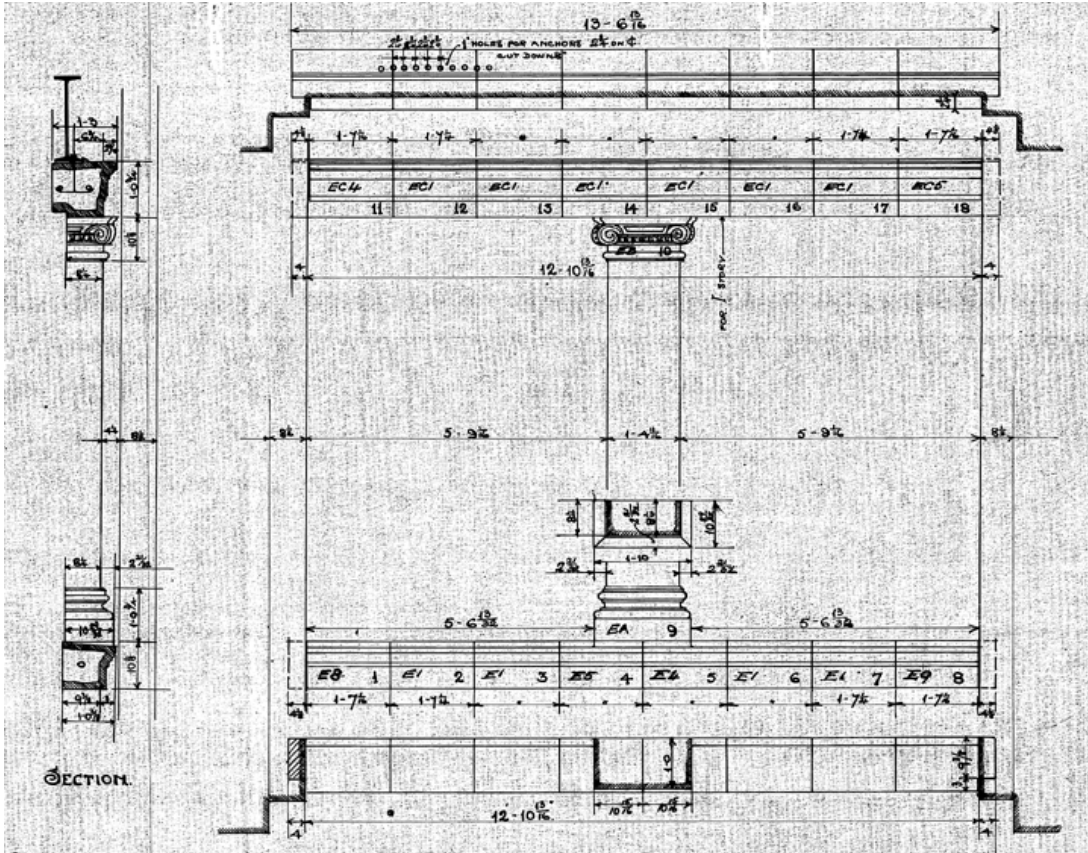

Figure 43. Construction drawing of terra cotta. Source: Gladding, McBean & Co., n.d.

There have been multiple terra cotta stabilization campaigns over the years; the most recent took place in 2006. The 2006 campaign included an inspection of the terra cotta pieces after a piece of masonry reportedly fell from the building. Inspection of the terra cotta resulted in additional units being identified as fall hazards. These units, including a keystone at a ninth floor arch on Mission Street, were removed from the façade and turned over to the building engineer. Interview with maintenance staff found these items may be lost. Occasionally exposed areas were patched with mortar. The area where the keystone was removed is an example of a mortar patch. The following photographs depict the investigation work and removal of deteriorated terra cotta features.



Figure 44. Cracking at cornice. Source: Rainbow Waterproofing, 2006.



Figure 45. Removal of cracked piece shown at left. Source: Rainbow Waterproofing, 2006.



Figure 46. Cracking at column base.
Source: Rainbow Waterproofing, 2006.



Figure 47. Removal of cracked piece shown at left.
Source: Rainbow Waterproofing, 2006.

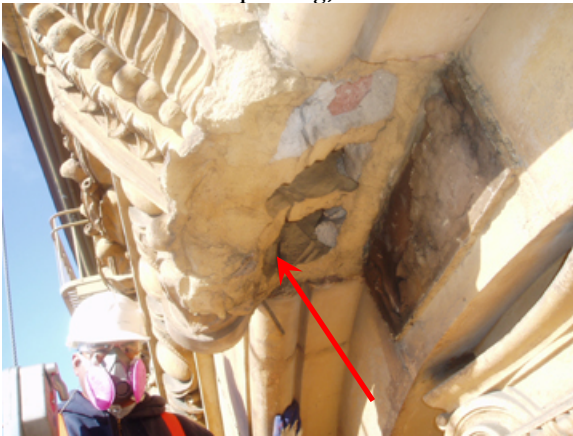

Figure 48. In-plane cracking of keystone.
Source: Rainbow Waterproofing, 2006.



Figure 49. Removal of cracked and mortar patch of piece shown at left. Source: Rainbow Waterproofing, 2006.



Figure 50. Cracking of sandstone.
Source: Rainbow Waterproofing, 2006.



Figure 51. Cracking of terra cotta brick.
Source: Rainbow Waterproofing, 2006.

Deterioration Conditions

Page & Turnbull surveyed the terra cotta using a telescoping lens from the ground level and also from the interior through the windows. Since the windows are fixed, physical contact with the material was prevented. In general, the terra cotta is in fair-to-poor condition, suffering from extensive cracking, bisque spalling, inappropriate or failed repairs, and mortar joint deterioration. The following are observed conditions:

Decorative Terra Cotta Conditions

- Bisque spalling (spall extending into the clay body) of the terra cotta occurs at all levels of both facades. Visual inspection shows the majority of spalls to be deep, exposing the void filler and inner block walls allowing rain water access into the wall assembly.
- Shallower bisque spalls occur at joints, particularly at window sills and the ninth floor arches (**Figures 52 & 53**). Typically bisque spalls of this nature are due to past pointing of the joint with a mortar that is too hard. If mortar is too hard, the terra cotta is unable to expand and contract, resulting in a spall or crack at the joint;
- Cracking of the terra cotta can be seen at the surface of many terra cotta units. While some hairline cracking is present, the majority of cracks are larger, penetrating into the clay body. Also observed were in-plane cracking, seen at a bisque spall (**Figures 54 & 54**);
- Previous repairs were observed in the form of non-matching mortar, partial mortar patches not covering an entire bisque spall and no patching mortar installed at bisque spalls (**Figure 56**);
- Mortar joints were observed to be in fair-to-poor condition with cracked and missing mortar (**Figure 57**). In some areas joints have been pointed with non-matching mortar. Additionally some joints have been repaired with sealant, which has dried, cracked, and deteriorated.

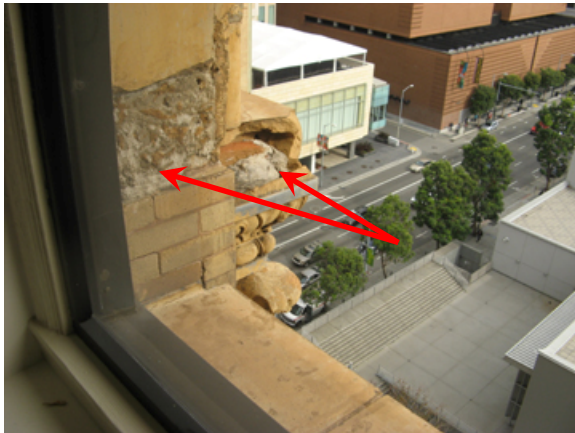

Figure 52. Deep bisque spall exposing void filler.
Source: Page & Turnbull, March 2010.



Figure 53. Shallow bisque spalls at joints.
Source: Page & Turnbull, March 2010.



Figure 54. Cracking at column base.
Source: Page & Turnbull, March 2010.



Figure 55. In-plane cracking at bisque spall.
Source: Page & Turnbull, March 2010.



Figure 56. Previous repair.
Source: Page & Turnbull, March 2010.

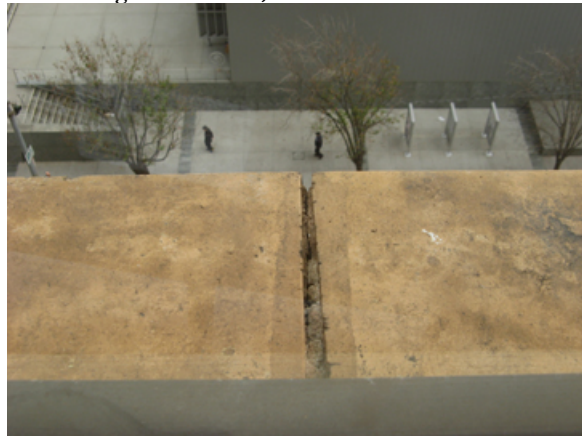

Figure 57. Cracking and missing mortar at sill joint.
Source: Page & Turnbull, March 2010.

Glazed Terra Cotta Brick Conditions

- Cracking of the glazed brick can be seen at vertical corners of the building, for example, at the columns which extend between the fourth and eighth floors. In some areas these cracks are continuous and extend multiple floor levels (**Figure 58**);
- Spalling of the brick occurs at the cracked areas described above. Localized to the corners of the window openings;
- Missing brick units also occur at the cracked areas described above. Localized to the corners of the window openings (**Figure 59**).



Figure 58. Cracking at column corner.
Source: Page & Turnbull, March 2010.



Figure 59. Missing brick.
Source: Page & Turnbull, March 2010.

Cast Iron (Significant Character-Defining Feature)

Description and History

Cast iron elements are located at the first and second stories of the Mission Street and 3rd Street facades. Elements include storefront frame of columns with scroll capitals at both first and second stories with additional cast iron divisions at the second story. Scrolls at column capitals at the first story on the 3rd Street façade are missing. The cast iron is painted dark brown, the same color as the painted sandstone.

Deterioration Conditions

The cast iron elements are in good condition with only minor signs of corrosion and paint failure. The following are observed conditions of the cast iron:

- Minor corrosion due to oxidization located at areas of paint failure (**Figure 60**);
- Paint failure, particularly at the second story horizontal surfaces (**Figure 61 & 62**);
- Missing elements (**Figure 63**).



Figure 60. Corrosion of cast iron.
Source: Page & Turnbull, March 2010.



Figure 61. Delaminating paint.
Source: Page & Turnbull, March 2010.



Figure 62. Area of exposed cast iron with no paint.
Source: Page & Turnbull, March 2010.



Figure 63. Missing scroll at column capital on 3rd Street facade. Source: Page & Turnbull, March 2010.

Sheet Metal Cornice (Significant Character-Defining Feature)

Description and History

The sheet metal cornice terminates the Mission Street and 3rd Street facades. The cornice includes a dentil band and modillions that align with the pilasters below. Penetrations through the cornice are located between dentils, allowing for installation of a staging apparatus. Additionally the fire escapes include a penetration through the cornice between the dentils. The sheet metal is painted a dark brown, the same color as the cast iron and sandstone at the base of the building.

Deterioration Conditions

The sheet metal cornice is in good condition. Observed conditions include:

- o Minor corrosion due to oxidization located at areas of paint failure;
- o Paint failure, particularly at the second story horizontal surfaces (**Figure 64**);



Figure 64. Area of exposed sheet metal with no paint.
Source: Page & Turnbull, March 2010.

Bronze Door Frame (Significant Character-Defining Feature)

Description and History

The bronze door frame is located at the 3rd Street entry at the north end of the facade. The bronze door frame and arched transom frame include a chain band pattern on the face of the frame.

Deterioration Conditions

The bronze frame is in good condition. Observed conditions include:

- General loose particulate soiling;
- Active corrosion in the form of greenish streaks and pits in the bronze surface (**Figure 65**);



Figure 65. Corrosion of bronze frame.
Source: Page & Turnbull, March 2010.

Wood Window Trim and Sills at Interior (Contributing Character-Defining Feature)

Description and History

The window trim and sills at the interior are wood, many of which are painted (**Figure 66**).

Deterioration Conditions

The wood trim and sills are in good condition.

Observed conditions include:

- Raised grain, likely due to past sandblasting;



Figure 66. Interior window trim.
Source: Page & Turnbull, March 2010.

Ceramic Floor Tile at Interior (Non-contributing historic fabric)

Description and History

The ceramic floor tile is located in the original entryway of the 3rd Street entrance. Much of the feature is gone or covered with non-original partition walls.

Deterioration Conditions

The ceramic tile is in fair to poor condition. Observed conditions include:

- Cracking of tile, likely due to function of space as freight transport, allowing large loads to bear on the tile;
- Staining, soiling and over coat of concrete at elevator threshold. **(Figure 67);**



Figure 67. Cracking and soiling of ceramic tile.
Source: Page & Turnbull, March 2010.

Roebbling Structural System (Contributing Character-Defining Feature)

Description and History

The Roebbling System is notable for its structural ingenuity. The structural system was typically covered by interior finishes and neither the concrete columns nor the slabs were exposed.

Deterioration Conditions

A structural engineer should assess the condition of the structural system

PART 2. TREATMENT AND WORK RECOMMENDATIONS

A. HISTORIC PRESERVATION OBJECTIVES

Based on Page & Turnbull's understanding of the Aronson Building and Aronson Historic District, as well as guidance provided by *The Secretary of the Interior's Standards for the Treatment of Historic Properties*, Page & Turnbull has considered four potential treatment options:

1. **Preservation:** Requires retention of the greatest amount of historic fabric, along with the building's historic form, features, and detailing as they have evolved over time.
2. **Rehabilitation:** Acknowledge the need to alter or add to a historic building to meet continuing or new uses while retaining the building's historic character.
3. **Restoration:** Allow for the depiction of a building at a particular time in its history by preserving materials from the period of significance and removing materials from other periods.
4. **Reconstruction:** Establish a limited framework for re-creating a vanished or non-surviving building with new materials, primarily for interpretive purposes.

Page & Turnbull did not consider in depth the fourth treatment option **Reconstruction**. Reconstruction is defined as the creation of a new structure identical in form, features, and details to a historic structure that no longer exists. The opportunity for Reconstruction does not exist at the Aronson Building.

Preservation

This treatment option would limit intervention to the repair and stabilization of the existing historic architectural features and materials of the Aronson Building. This treatment entails remedying all material and structural deficiencies identified in this HSR, as well as instituting a maintenance plan to ensure that the building is properly and regularly maintained. The possible advantage of this approach is this treatment will not result in any substantial disruption to the Aronson Historic District. The relative cost of repairs may be lower than other treatment alternatives. The major drawback is that missing features and materials would not be replaced, new improved building systems would be difficult to introduce, and opportunities for programmatic planning alterations and new uses would be limited.

Rehabilitation

Rehabilitation is the treatment alternative typically selected in cases where compatible new uses or additions are contemplated as part of the project. Rehabilitation goes a step further than preservation. In addition to conducting necessary repairs, rehabilitation guidelines allow for additional work to replace missing elements and restoration of important public areas. This treatment option provides greater flexibility by allowing alterations and additions to accommodate a compatible use.

Rehabilitation would be the most ideal of all potential treatments because it would be possible to restore the building close to its original appearance, removing inappropriate alterations and restoring finishes while making improvements to fire-protection systems, environmental systems, and energy conservation. It would also provide the opportunity for new sensitively designed additions, compatible to the historic character, to be constructed at secondary facades.

Restoration

According to a strict interpretation of the Restoration Standards, the treatment option of restoration would require the reestablishment of a specific past period at the Aronson Building and/or the Aronson Historic District, presumably the reconstructed 1906 condition. This option would result in the removal of all post-1906 exterior alterations and the restoration of missing materials and elements. A full restoration of the building would need to be accomplished with strict authenticity. A strict restoration of the Aronson Building would unnecessarily limit flexibility to incorporate modern amenities and updated building systems, and limit the ability of the historic building to accommodate the needs of current owners and tenants. It would preclude the ability to construct sensitive new additions. Therefore, the restoration treatment is not proposed for the Aronson Building.

Recommended Treatment

Page & Turnbull recommends the adoption of rehabilitation as the treatment option for the Aronson Building. This strategy is superior to the other options, because it promotes the repair and protection of character-defining features of the building, while simultaneously allowing for necessary programmatic improvements and infrastructure improvements. Additions should be designed so that they are distinct, yet compatible with the historic resource and consistent with the *Secretary of the Interior's Standards for Rehabilitation*.

The Aronson Building has had incremental interior alterations resulting in a substantial loss of interior historic fabric. Therefore, remaining historic fabric and character-defining features should be retained where possible. See the Preferred Treatment Recommendations for further information. Many areas, such as open office areas, have been altered and will undoubtedly continue to be altered in the future in order to serve the building's future use; the rehabilitation treatment option will allow for flexibility when dealing with non-contributing areas while retaining and restoring important features.

B. REQUIREMENTS FOR WORK

Laws, Regulations & Functional Requirements

This section outlines applicable laws, regulations and functional requirements, which must be taken into account prior to any rehabilitation work at the Aronson Building.

Any rehabilitation of the Aronson Building should be evaluated with respect to conformance with applicable state and municipal codes and standards required by law and National Park Service policy. All work to the building must comply with the *California Building Code (CBC) and Title 24 Part 8 of the California Code of Regulations*. As a qualified historic building, the Aronson Building is eligible to take advantage of the *California Historical Building Code (CHBC)* with regard to code compliance. The CHBC is intended to be used by any agency with jurisdiction when reviewing code compliance for a qualified historic building in order to insure its preservation. As stated in the CHBC Section 8-101.2:

The CHBC is intended to provide solutions for the preservation of qualified historical buildings or properties, to promote sustainability, to provide access for persons with disabilities, to provide a cost-effective approach to preservation, and to provide for reasonable safety of the occupants or users. The CHBC requires enforcing agencies to accept solutions that are reasonably equivalent to the regular code (as defined in Chapter 8-2) when dealing with qualified historical buildings or properties.

C. WORK RECOMMENDATIONS AND ALTERNATIVES

This section of the HSR presents a plan that includes a list of tasks and solutions for the conservation and rehabilitation of the Aronson Building. The plan recommends several options for rehabilitation treatments that could be considered during the design process of a future project. It also serves as a guide to standard practice for future maintenance, repair and replacement of historic materials based on the Secretary of the Interior's Standards for Rehabilitation.

Secretary of the Interior's Standards for the Treatment of Historic Properties

The Secretary of the Interior's Standards are the benchmark by which Federal agencies and many local government bodies evaluate rehabilitative work on historic properties. The Standards are a useful analytic tool for understanding and describing the potential impacts of substantial changes to historic resources. Compliance with the Standards does not determine whether a project would cause a substantial adverse change in the significance of an historic resource. Rather, projects that comply with the Standards benefit from a regulatory presumption that they would have a less-than-significant adverse impact on an historic resource.⁵⁰

The Standards provide guidelines for four treatments of historic properties: Preservation, Rehabilitation, Restoration, and Reconstruction. The *Standards for Rehabilitation* outline appropriate maintenance and repair treatments for a historic structure.⁵¹ This treatment calls for a strategy of utilizing the property for a contemporary new use through repair and alteration while preserving historically significant portions and features of the building. The *Secretary of the Interiors Standards for the Rehabilitation* are as follows:

1. *A property shall be used for its historic purpose or be placed in a new use that requires minimal change to the defining characteristics of the building and its site and environment.*
2. *The historic character of a property shall be retained and preserved. The removal of historic materials or alteration of features and spaces that characterize a property shall be avoided.*
3. *Each property shall be recognized as a physical record of its time, place, and use. Changes that create a false sense of historical development, such as adding conjectural features or architectural elements from other buildings, shall not be undertaken.*
4. *Most properties change over time; those changes that have acquired historic significance in their own right shall be retained and preserved.*
5. *Distinctive features, finishes, and construction techniques or examples of craftsmanship that characterize a property shall be preserved.*
6. *Deteriorated historic features shall be repaired rather than replaced. Where the severity of deterioration requires replacement of a distinctive feature, the new feature shall match the old in design, color, texture, and other visual qualities and, where possible, materials. Replacement of missing features shall be substantiated by documentary, physical, or pictorial evidence.*
7. *Chemical or physical treatments, such as sandblasting, that cause damage to historic materials shall not be used. The surface cleaning of structures, if appropriate, shall be undertaken using the gentlest means possible.*

⁵⁰ CEQA Guidelines subsection 15064.5(b)(3).

⁵¹ Kay D. Weeks and Anne E. Grimmer, *The Secretary of the Interior's Standards for the Treatment of Historic Properties with Guidelines for Preserving, Rehabilitating, Restoring, and Reconstructing Historic Buildings* (Washington, D.C.: U.S. Department of the Interior National Park Service, 1995), 2.

8. *Significant archeological resources affected by a project shall be protected and preserved. If such resources must be disturbed, mitigation measures shall be undertaken.*
9. *New additions, exterior alterations, or related new construction shall not destroy historic materials that characterize the property. The new work shall be differentiated from the old and shall be compatible with the massing, size, scale, and architectural features to protect the historic integrity of the property and its environment.*
10. *New additions and adjacent or related new construction shall be undertaken in such a manner that if removed in the future, the essential form and integrity of the historic property and its environment would be unimpaired.*

General Recommendations

The general recommendations section provides guidance on planning and design for future work as it relates to the Aronson Building. The building may require rehabilitation for a new use in the future. These recommendations outline potential areas for further study in order to protect and maintain the character-defining features and integrity of the building.

Façade Assessment

What follows in the Recommendations section provides general recommendations based upon 1) our visual observation from grade and building windows, 2) our previous experience with the materials found on the façade, and 3) industry standard repairs for these materials. In order to provide more detailed repair information, a more detailed investigation to uncover specific causes and sources of deterioration is required. When planning a future project the first task is to conduct a complete and thorough survey of the façade prior to design of the repair. Investigation should be completed by a well qualified architect and/or engineer familiar with historic structures and applicable treatments in accordance with the *Standards* and governing codes. Investigation of the façade may include but not be limited to the following:

- Up-close investigation by use of scaffold, swingstage, or mechanical lift;
- Use of non-destructive investigation techniques such as sounding with plastic or wood mallet, metal detection, infrared thermography, and impact echo testing;
- Use of destructive testing such as investigative openings to evaluate underlying systems and conditions.
- Sample removal and materials testing such as mortar analysis and petrographic analysis.

Based on the visual survey conducted for this report, the levels of deterioration observed warrant a full façade assessment in the near future.

Temporary Stabilization

Following a close-up inspection of the building façade, it may be necessary to temporarily stabilize elements that pose a safety hazard. The primary objective of a stabilization campaign is to either remove or anchor the unstable elements in order to avoid any potential safety hazards while preserving the historic fabric. Additionally, measures should also be taken to arrest water infiltration into the wall system to prevent further deterioration.

Stabilization repairs should be structurally sound, non-invasive, reversible and durable for the life of the repair. Repair techniques may include the following:

- Sheet metal enclosures;
- Debris netting;
- Stainless steel straps;
- Helical anchors;
- Protective canopy at street level.

Stabilization is not recommended as a long-term repair. Monitoring stabilization repairs once every year is recommended and should continue until permanent repairs are completed. Monitoring should look for additional areas of concern as well as inspection of previous stabilization repairs.

Preferred Treatments for Rehabilitation

The rehabilitation of the Aronson Building should consider the following preferred treatments for rehabilitation:

Protect, maintain and preserve character-defining features. Repair and treat character-defining features⁵² to return their structural integrity and aesthetic appearance where appropriate. Where materials are beyond repair, replacement of materials will be acceptable. Replacement with in-kind materials is preferred; however, alternative materials may be explored so long as they can comply to the *Standards* and material performance criteria. Historic fabric may be altered to accommodate necessary building upgrades where they do not impact significant spaces. However, these features should be retained where possible when not in conflict with the building or spaces new use.

New construction, additions and alterations should include measures to protect historic fabric considered to be significant and character-defining and/or contributing to the integrity of the building. The *Standards* recognize that new construction is often needed in order to adapt a historic building to a new use. Should a future project require new construction or an addition, the new work should be designed so that it is compatible yet differentiated from the historic building. Where a new building is constructed adjacent to the historic building, a successful method of linking the new building with the historic is through the use of a transparent connector. The connector would be built in a way that would minimize damage to historic fabric. Recessing the connector from the face of the historic façade would visually separate the historic building from the new. Alternatively, the new construction could step back from the Aronson building so that the form and massing of the historic building is conveyed and the new construction is recognized as separate. A protection plan should be developed in order to protect the character-defining features of the Aronson Building prior to the construction of an adjacent building or an addition.

Historically the two red brick masonry facades at the northwest and southwest were designed to accommodate construction of adjacent buildings, sharing the existing wall of the Aronson Building. Throughout its history there have been adjacent buildings at these locations. As such, these façades would be appropriate locations for additions.

New construction, mechanical equipment and/or roof garden elements placed at the roof should not visually dominate the views of the building. Setting features back from the roof edge will ensure that the features are not visually dominant to pedestrians at street level immediately surrounding the building (from sidewalks across the street from primary facades). Use of computerized 3-D

⁵² For list of character-defining features, see “C. Physical Description under Part I. Developmental History.”

modeling of the building and/or mock-ups of the proposed additions should be conducted prior to construction to determine sight lines and appropriate buildable heights and area at the roof.

Rehabilitation should consider sustainable solutions that improve energy efficiency and water conservation without compromising the buildings historic integrity. A rehabilitation project may consider an energy study of the building to better understand the inherent properties of the existing resource and how to use those features to their best advantage. The project may consider the following:

- Use of low-e and/or insulated glazing at windows and storefronts
- Making new windows operable to make use of natural ventilation
- Installation of lighting fixtures and controls that improve efficiency
- New high efficiency heating system
- Use of photo-voltaic panels at the roof top, so long as the panels are not visible from street level.
- Use of low flow toilet fixtures

Design new storefronts at ground level to replace existing non-original storefront enclosures. The existing cast-iron storefront elements should be maintained and protected. The new storefronts may be contemporary in design; however, they should be designed so that they are compatible with the historic character of the building. Historic photographs (**Figure 10**) should be referenced and any divisions or patterns in the fenestration should be compatible with the historic design. Materials to consider include steel and painted aluminum. See the provided sketch for guidance on design of this feature (**Figure 68**).

The ground floor could potentially accommodate a single retail/restaurant tenant or several tenants at any given time. The design for signage, awnings, lighting, storefronts, and building entrances should promote a unified ground floor that is sympathetic to the historic character of the building. The design should address location and method of attachment for these features and should be reviewed by the San Francisco Planning Department.

Replace existing non-original windows with new windows of a style appropriate to the historic character of the building. The original wood windows were replaced with aluminum windows. Design of the new windows should be based upon physical or pictorial evidence. Since the original wood windows are no longer extant, the only physical evidence remaining is the wood sills. The pictorial evidence consists of historic photographs taken from distances that do not reveal sufficient detail of the dimensions of the stiles and rails of the original windows nor their original profiles. Therefore, there are two acceptable options for the replacement windows:

1. Replace the windows with metal or wood windows that appear to have similar proportions to the stiles and rails in the historic photographs and that have a profile compatible to what might have been used at that time.
2. Replace the windows with metal or wood windows that appear to have similar proportions to the stiles and rails in the historic photographs and that have no profile.

The operability and type of windows is dependent upon the building's use and code restrictions; however, type of operation should consider the historic single sash vertical pivot type. The method of operation is not as important as the overall physical appearance and proportions of the new windows. New windows could be constructed of wood or metal as noted above. See the provided sketch for guidance on design of this feature (**Figure 68**). Interior wood trim and sill are noted as character-defining and should be preserved and protected.

New openings at the north and west façades. The north and west façades have historically been mostly solid, with some openings inserted over time. These façades were intended as party walls that could be obscured by adjacent construction. Future projects may consider new openings at these façades. New openings in these façades should be kept well away from the south and east façades in order to retain the historical expression of the solid wall at the corner. At the west façade, new openings should be set back four to five feet from the corner. At the north façade, new openings should be setback three to five feet. Additionally, the total square feet of new openings at the north façade should not exceed 50 percent of the total façade square footage.

According to the *Secretary of the Interior's Standards for the Rehabilitation*:

“such design should be compatible with the overall design of the building, but not duplicate the fenestration pattern and detailing of a character-defining elevation.”

In summary, new openings should be compatible but distinguished from the historic windows.

Remove abandoned metal fire escapes from the building façade. The fire escapes are no longer in use, nor are they required per California Building Code. The fire escapes should be removed and impacted materials repaired to their original appearance.

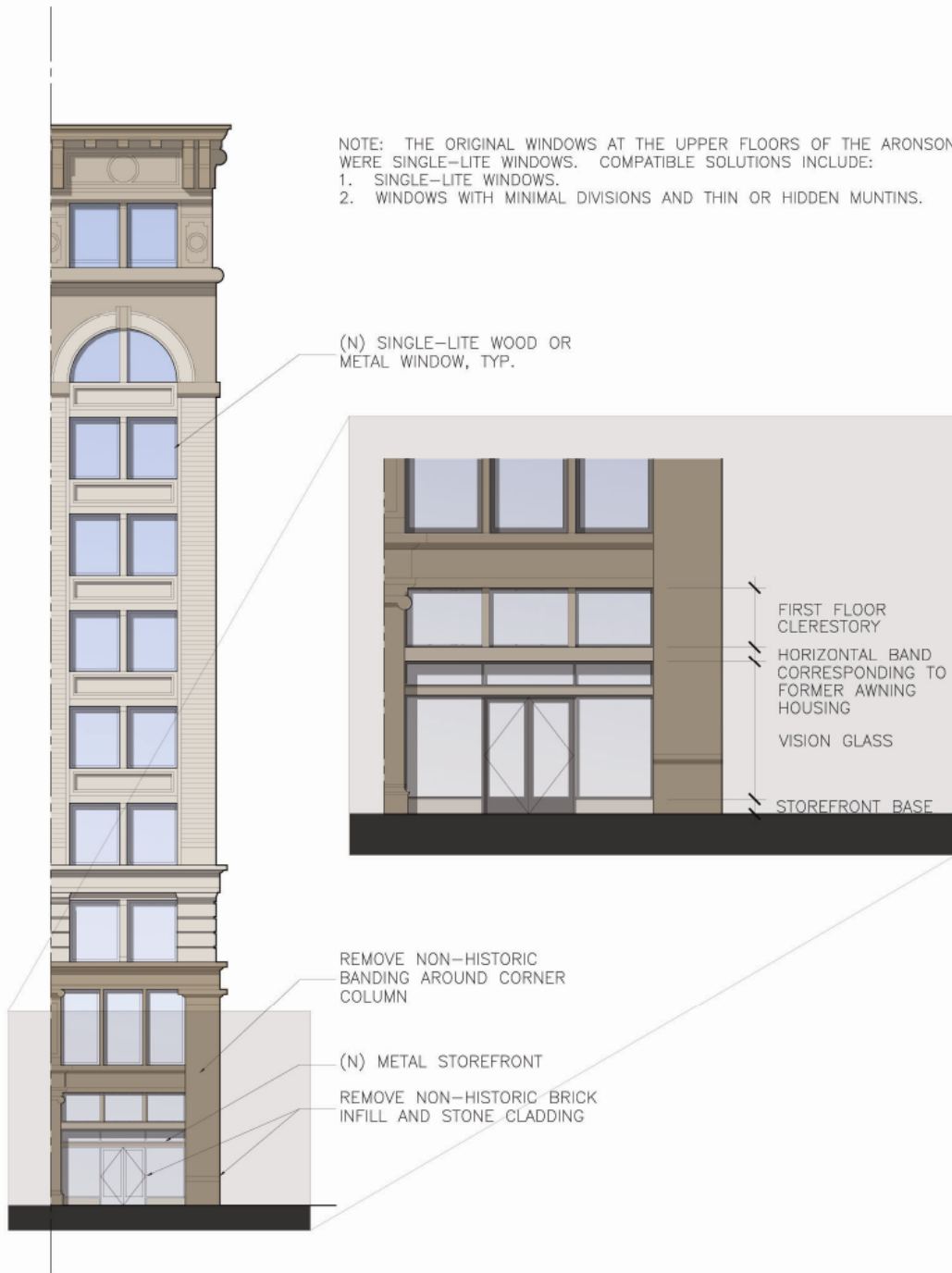

Figure 68. Page & Turnbull sketch of a recommended design option for storefront and windows.

General Treatment for Common Materials

Several renovation projects at the interior removed much of the historically significant spaces and features of the building, such as the entry vestibules, elevator cabs and doors, and room finishes. Therefore the conservation treatments are largely confined to the exterior of the building, where the collection of historic fabric is the greatest. The historic exterior has not experienced any extensive restoration project beyond general maintenance and repair. The following sections include general guidelines to follow when repairing and maintaining the historic fabric. The recommendations follow the *Standards* and reference the National Park Service's *Preservation Briefs* publications⁵³ available on-line. The following National Park Service's *Preservation Brief* titles are recommended resources for further information:

- *Preservation Brief 1 – Assessing Cleaning and Water-Repellent Treatments for Historic Buildings*
- *Preservation Brief 2 – Repointing Mortar Joints in Historic Masonry Buildings*
- *Preservation Brief 6 – Dangers of Abrasive Cleaning to Historic Buildings*
- *Preservation Brief 7 – Preservation of Historic Glazed Architectural Terra Cotta*
- *Preservation Brief 11 – Rehabilitating Historic Storefronts*
- *Preservation Brief 24 – Heating, Ventilating and cooling Historic Buildings*
- *Preservation Brief 27 – The Preservation and Repair of Architectural Cast Iron*
- *Preservation Brief 38 – Removing Graffiti from Historic Masonry*
- *Preservation Brief 39 – Controlling Unwanted Moisture in Historic Buildings*
- *Preservation Brief 41 – The Seismic Retrofit of Historic Buildings*
- *Preservation Brief 42 – The Maintenance, Repair and Replacement of Historic Cast Stone*

The recommendation section is organized by building material. Execution of the work described in the section should be carried out by qualified contractors and/or maintenance staff with experience in working with historic buildings and materials. Work should be designed and overseen by a qualified architect and/or engineer.

Brick Repair Recommendations (Contributing Character-Defining Feature)

Seismic Reinforcing

A structural engineer should make recommendations on the seismic upgrade of the unreinforced masonry, with consultation from a preservation architect. It is likely that the brick masonry will need to be covered in areas. The preservation architect should consider the seismic application and how it may affect character-defining features and the building's integrity.

Cracked Units

Areas observed to have cracked masonry units should be repaired as follows:

- Remove cracked masonry units by use of grinders and hand tools. Take care not to overcut surrounding brick.
- Inspect surface behind masonry for evidence of corrosion of steel anchoring system. Repair steel as required.
- Install new brick masonry unit to match existing in dimensions, color and texture as feasible. New mortar to match the original mortar in color, texture and tooled profile.

⁵³ Preservation Briefs, Technical Preservation Services, National Park Service. Available at: <http://www.nps.gov/history/hps/tps/>

Repointing

Where required, repoint masonry as follows:

- Remove old mortar to depth of at least 2- 1/2 times the width of the joint or to sound mortar, whichever is greater. Remove mortar by use of grinders and hand tools. Take care not to overcut surrounding masonry units.
- Repointing mortar should be mixed to match a freshly broken sample of the original, and should not be stronger than the brick. This process may require laboratory analysis of existing mortar to ensure correct mix is installed.
- Repointing mortar should match the original mortar in color, texture and the joint profile should match the original joints.
- Install mortar in 1/4 inch lifts to fill the joint flush to the outer surface. When the final layer is thumbprint hard, tool the joint to match surrounding original mortar.

Cleaning

Previous sandblasting of the brick has resulted in pitting of the masonry surface and deterioration of the mortar joints. The brick may have an increased absorption rate due to blasting and therefore would absorb a greater amount of chemical cleaners when applied. Additional testing of the masonry and pointing of the deteriorated mortar joints should be conducted prior to any cleaning of the facades. Cleaning of the brick must exercise extreme caution and mock-ups should be conducted to ensure no damage will occur as a result of cleaning. Localized stains or marks from vandalism may be cleaned as necessary but cleaning procedures should be limited to the affected area rather than the entire wall. Any masonry cleaning procedures for this building must follow the standard of practice outlined in *Preservation Brief 1 – Assessing Cleaning and Water-Repellent Treatments for Historic Masonry Buildings*.

Colusa Sandstone Recommendations (Significant Character-Defining Feature)

Deterioration of Colusa sandstone is a natural weathering process and therefore cannot be completely arrested. The deterioration can be slowed down by repairing already damaged material and reducing the amount of water penetrating the stone.

Paint Removal

The paint covering the sandstone should be removed. If coatings are not breathable, they can accelerate the deterioration of the stone. Additionally, the existing painted surface makes identifying cracks, spalls, and areas of repair more difficult. Mock-ups of the paint removal process, testing several options, are recommended in order to choose the best approach.

Repair

- Remove all unsound sandstone spalls;
- Inspect substrate for embed steel anchors, repair steel as required;
- Reinforce larger or deep spalls with stainless steel threaded rods, smaller or shallow patches need not be reinforced;
- Patch sandstone units with composite patching mortar of a color that matches the existing sandstone. Patching material must be breathable and have similar thermal expansion characteristics of the original stone;

Replacement

Replacement of the sandstone may be required where the damage is severe and beyond repair. Replacement of entire blocks or partial replacement with a Dutchman repair is costly. It is also difficult to match the sandstone exactly since in many cases the original quarry is closed. Cutting, dressing and installation of the replacement stone is labor intensive and should be conducted by a skilled craftsman familiar with restoration of historic stone.

Replacement with new sandstone to match the existing is preferred in order to comply with the *Standards*, although substitute materials are one option that is sometimes considered. Substitute materials may include glass fiber reinforced concrete (GFRC) and cast stone. The replacement material should be visually compatible. However, it should be understood that an alternate material will weather differently than the adjacent sandstone, therefore the replacement stones may become visually pronounced over time. It is of great importance that the replacement materials contain properties similar to the existing sandstone, for example compressive strength and expansion/contraction coefficient. Due to the complexities of this type of repair, the process should be carefully monitored and include testing of existing and replacement materials, mock-ups, shop drawings and full scale submittal samples.

Flashings and Coatings

Design and installation of flashings at horizontal surfaces should be examined for water infiltration. A flashing system will ensure that water is able to shed off and away from the stone. Flashing should be replaced at areas of water infiltration. Flashing will need to be integrated with the wall system at the stone-to-masonry interface.

All existing paint coatings should be removed from the sandstone by gentlest means possible. Use of a clear, breathable siloxane/silane based water repellent coating would aid in mitigating water penetration into the stone. A mock-up of proposed coatings should be conducted prior to selection of a product. A coating should not alter the natural finish, color or texture of the stone.

Terra Cotta Repair Recommendations (Significant Character-Defining Feature)

Cleaning

The general consensus among preservation professionals is that cleaning terra cotta can be risky and may sometimes produce devastating effects. The objective for cleaning historic materials is not to reach 100 percent clean, but closer to 75 or 80 percent. The following methods for cleaning should be avoided:

- Abrasive Clearers and Sandblasting: Abrasive cleaning for terra cotta, especially with glazed surfaces should not be considered.
- Strong Acids (particularly fluoride based acids): Many commercially available chemical cleaners contain hydrofluoric acid which can etch the glaze of the terra cotta very seriously, removing most of the surface sheen. Use of acids may deteriorate mortar and “liberate” salts within the masonry system producing efflorescence.
- Alkaline Cleaners: May cause little or no damage to the glaze, but if absorbed into the masonry material can cause efflorescence.
- High Pressure Water: Water seepage into masonry wall may cause rusting of metal anchoring.
- Use of metal bristle brushes.

Cleaning campaigns should begin with testing the gentlest means possible and may require several mock-ups prior to selection of the proper technique. A combination of hand scrubbing with a stiff nylon brush and a minimum of water washing is the most conservative approach and least harmful to the material. Depending on the level of soiling a low-pressure wash (100 to 400 psi) may be sufficient to remove soiling. A natural organic detergent may prove useful as well.

Spalls

With the extensive amount of bisque spalling at the Aronson Building options for treatment include patching of spalls and replacement of the terra cotta unit. For more information on the option of replacement see the *Replacement* category of this section.

Patching of terra cotta bisque spalls would include:

- Reinforcing patches for larger or deep spalls with stainless steel threaded rods. Smaller or shallow patches need not be reinforced.
- Selection and application of patching mortar that matches the existing terra cotta color, texture and profile, paying particular attention to matching compressive strength and vapor transmission properties.
- Application of an acrylic or latex coating system to match the existing slip glaze.

Coating systems on terra cotta have an expected life span of ten years at best. Future failures of this repair may include fading, chalking and delamination. A future maintenance plan should include ongoing inspection and maintenance of the coatings.

Cracks

Cracking of the terra cotta is usually caused by underlying conditions, most commonly corrosion of steel anchoring and structural support systems. As discussed in the Existing Conditions section, further investigation of this condition is required before a specific repair can be designed. In general the procedure for repair of terra cotta cracks includes:

- Inspection of terra cotta for underlying conditions;
- Repair of any underlying conditions and stabilization of the masonry unit;
- Repointing and finishing with a coating system. Cracks from 1/32 inch to 1/8 inch in width should be routed out and filled with a proprietary flexible epoxy crack sealant for masonry;
- Hairline cracks should be periodically monitored to ensure that they are not expanding and do not require immediate treatment.

Mortar

Repointing of cracked and deteriorated mortar joints is the first step in mitigating water infiltration into the wall system. Because joints in terra cotta need to “breathe,” pointing joints with sealant is not recommended. Recommendation for pointing of joints includes:

- Removal of deteriorated mortar without damaging surrounding terra cotta;
- Selection of pointing mortar that matches the existing mortar in color and texture. Mortar that is soft and lime-based (weaker than the surrounding terra cotta) will allow for expansion and contraction of the terracotta;
- Installation of mortar to match surrounding mortar.

Replacement

Replacement of the terra cotta units may be necessary when large pieces or whole units are missing. The *Secretary of the Interior's Standards for Rehabilitation* states:

“Deteriorated historic features will be repaired rather than replaced. Where the severity of deterioration requires replacement of a distinctive feature, the new feature will match the old in design, color, texture, and, where possible, materials. Replacement of missing features will be substantiated by documentary and physical evidence.”

Although substitute materials are one option, replacement with new terra cotta to match the existing is preferred in order to comply with the *Standards*. Cost and time constraints associated with fabrication of new terra cotta may require exploration of substitute materials. Substitute materials may include glass fiber reinforced concrete (GFRC) and pre-cast concrete. In both cases of replacement in-kind or use of substitute materials, the replacement material should be visually compatible. Additionally, it is of great importance that the replacement materials contain properties similar to the existing terra cotta, for example compressive strength and expansion/contraction coefficient. Due to the complexities of this type of repair, the process should be carefully monitored and include testing of existing and replacement materials, mock-ups, shop drawings and full scale submittal samples.

Architectural Cast Iron (Significant Character-Defining Feature)

Paint Restoration Recommendations

Areas observed to have extensive failure of the paint coating and/or corrosion should be repaired as follows:

- Remove failing paint by use of wire brush or chemical paint stripper;
- Remove rust and corrosion with wire brush just before priming;
- Prime exposed cast-iron with a zinc-rich rust inhibitor coating;
- Paint all cast-iron elements with an epoxy base coat, and two urethane finish coats.

Missing cast iron elements, such as the missing scroll capitals along Third Street, should be replaced. Substitute materials, provided they comply with the *Standards*, are acceptable.

Architectural Sheet Metal Cornice (Significant Character-Defining Feature)

Paint Restoration Recommendations

Areas observed to have extensive failure of the paint coating and/or corrosion should be repaired as follows:

- Remove failing paint by use of wire brush or chemical paint stripper;
- Remove rust and corrosion with wire brush just before priming;
- Prime exposed metal with a zinc-rich rust inhibitor coating;
- Paint all sheet metal elements with an epoxy base coat, and two urethane finish coats

The cornice was cut to accommodate the fire escape ladder from the roof. If the ladder is removed, the cornice should be repaired. Additionally, part of the original cornice return that once wrapped around the building was cut off to build the 1970's addition. If the addition is removed, the cornice should be repaired.

Bronze Door Frame (Significant Character-Defining Feature)

Cleaning Restoration Recommendations

The bronze door frame should be cleaned and protected as follows:

- Remove any surface wax, soiling or grease with a solvent or power washing;
- Treat corroded areas with a heat applied chemical patina to match the historic patina;
- Apply a proprietary polymer coating such as Inctalac (a standard protective coating for bronze sculpture), as well as a protective microcrystalline wax layer.

Wood Window Trim and Sills at Interior (Contributing Character-Defining Feature)

Paint Restoration Recommendations

Since the wood elements appear to have been sandblasted, it is unlikely that a paint analysis study would reveal the historic finish of the trim and sills. Therefore, options for finishing include:

- Restoration back to bare wood with a clear or stain finish;
- Restoration back to bare wood with a painted finish, with no restrictions on color.

Paint removal should be conducted as follows:

- Remove failing paint by use of chemical paint stripper, do NOT sandblast wood;
- Sand wood to smooth finish to remove current raised grain texture, take care not to sand away any existing decorative detailing;
- Finish wood as desired.

Exterior windows (Non-Contributing Feature)

As discussed in the Preferred Treatments Recommendations section, the modern windows should be replaced with new windows that are sensitive to the historic character of the building. However, because the existing windows are only halfway through their expected service life, it would be acceptable (but not required) to defer replacement until the end of their service life. In the future, when the windows are in need of replacement, new windows should be designed in a style that is appropriate for the historic character of the building.

Based on historic photographs (**Figures 9 & 10**), the original windows were simple, single-lite wood windows. Replacement windows should be based on physical and pictorial evidence and incorporate similar proportions as the windows in the historic photographs. Replacement windows should also fill the original window opening. Recreation of the replacement windows is not required to meet the Standards and substitute materials may be acceptable.⁵⁴

Ceramic Floor Tile at Interior (Non-contributing historic fabric)

The ceramic tile is original historic fabric, although it is not a character-defining feature. The tile is in poor condition and exists as a fragment. Although retaining historic fabric wherever possible is recommended, its removal would not result in an adverse affect on the building.

Roebbling Structural System (Contributing Character-Defining Feature)

Recommendations for the seismic upgrade of the structural system should be completed by a structural engineer with consultation from a preservation architect. As stated in the conditions assessment, the concrete finish of the structural system was likely not exposed, with the exception of the basement. Therefore, covering the concrete structural system with interior finishes is an appropriate treatment.

⁵⁴ Technical Preservation Services, National Park Service, "Replacement Windows that Meet the Standards," Historic Preservation Tax Incentives Program (December 2007) 4.

REFERENCES

PUBLISHED

- Charles Hall Page & Associates and the Foundation for San Francisco's Architectural Heritage. *Splendid Survivors*. San Francisco: Modern Living Books, 1978.
- Himmelwright, A.L.A. *The San Francisco Earthquake and Fire – A Brief History of the Disaster*. The Roebling Construction Company, 1906.
- Kay D. Weeks and Anne E. Grimmer, *The Secretary of the Interior's Standards for the Treatment of Historic Properties with Guidelines for Preserving, Rehabilitating, Restoring, and Reconstructing Historic Buildings*. Washington, D.C.: U.S. Department of the Interior National Park Service, 1995.
- Kelley and VerPlanck, District Record for New Montgomery, Mission and Second Historic District, 23 July 2008.
- Kelley and VerPlanck Historical Resources Consulting, *Transit Center District Survey, San Francisco, California*, 22 July 2008.
- Technical Preservation Services, National Park Service, "Replacement Windows that Meet the Standards," Historic Preservation Tax Incentives Program, 2007.
- Richards, Rand. *Historic San Francisco. A Concise History and Guide*. San Francisco: Heritage House Publishers, 2001.
- Searls, Carolyn L., Joshua M. Marro and Ronald L. Mayes. *APT Bulletin Vol. 36, No. 2/3 - A Mausoleum on Shaky Ground: de la Montanya Mausoleum, Cypress Lawn, Colma, California*, Association for Preservation Technology International, 2005.
- Woodbridge, Sally B. *San Francisco in Maps & Views*. New York: Rizzoli, 2006.

PUBLIC RECORDS

- Bancroft Library, University of California, Berkeley
- California State Library
- San Francisco Assessor's Records
- San Francisco City Directories
- San Francisco Department of Building Inspection, Building Permits
- Sanborn Fire Insurance Maps for 1899-1900, 1913-1915, 1913-1950, and 1988.
- San Francisco Public Library Historical Photograph Collection

NEWSPAPERS AND PERIODICALS

Borsuk, Dan. "Doomed Building has Reprieve," *The San Francisco Chronicle* (20 June 1975).

"Down-town Owner Holds to Old Price," *The San Francisco Chronicle* (17 May 1906) 9.

"Mother Seeks to Restrain Son," *San Francisco Call* (December 30, 1909), p. 10.

"Third and Mission Street Structure," *The San Francisco Chronicle* (28 December 1902) 12.

San Francisco Architectural Heritage, *Heritage News* (xxxiv:2) 7.

"Some Winners in San Francisco Real Estate," *The San Francisco Call* (15 April 1906) 13.

INTERNET SOURCES

San Francisco Planning Department. "Transit Center District Plan: Draft for Public Review, November 2009." Website accessed on 1 April 2010 from: http://www.sf-planning.org/ftp/CDG/docs/transit_center/Transit_Center_District_Plan_Public_Draft_WEB.pdf

National Park Service, Technical Preservation Services, "Preservation Briefs", Website accessed on 1 April 2010 from: <http://www.nps.gov/history/hps/tps/>

OTHER

Charles Hall Page & Associates, Historical Resource Inventory, DPR523 for the Mercantile Building, July 1978.

Corbett, Michael. Untitled History of the Aronson Building, April 1975.

Knapp Architects. *Supplemental Information Form for Historic Resource Evaluation, 706 Mission Street*, September 2008.

Masaoka, Tad, HUD. *E.O.11593: Determination of Eligibility Notification for the National Register of Historic Places, Office of Archeology and Historic Preservation*, 27 March 1978.

APPENDICES

Charles Hall Page & Associates. Historic Resources Inventory Form (DPR523) for the Mercantile Building, March 1978.

Masaoka, Tad, HUD. *E.O.11593: Determination of Eligibility Notification for the National Register of Historic Places, Office of Archeology and Historic Preservation*, 27 March 1978.

Historic Drawings

HISTORIC RESOURCES
INVENTORY FORM
1978

State of California - The Resources Agency
DEPARTMENT OF PARKS AND RECREATION

HISTORIC RESOURCES INVENTORY

0007-1084

Ser. No. _____	
HABS _____	HAER _____
UTM: A10/552740/5182060	NR <u>22</u> SHL _____ Loc _____
C _____	D _____

IDENTIFICATION

1. Common name: Mercantile Building 38-4101-294-0001
2. Historic name: Axonson Building (part of)
3. Street or rural address: Mission Street, 700
City San Francisco Zip 94103 County San Francisco
4. Parcel number: _____
5. Present Owner: San Francisco Redevelopment Agency Address: 820 Howard
City San Francisco Zip 94103 Ownership is: Public Private _____
6. Present Use: commercial Original use: office building

DESCRIPTION

- 7a. Architectural style: _____
- 7b. Briefly describe the present physical description of the site or structure and describe any major alterations from its original condition:

This ten story building consists of a glass base with a massively skeletal shaft vertically articulated. The design culminates in a richly embellished arcade and a two story capital that includes small round windows in reference to such Sullivan skyscrapers as the Guaranty and Wainwright buildings. Renaissance/Baroque ornamental details are overscaled to be legible and to enhance the massiveness of the top. The exterior is of stone, brick, and terra cotta in brown shades.

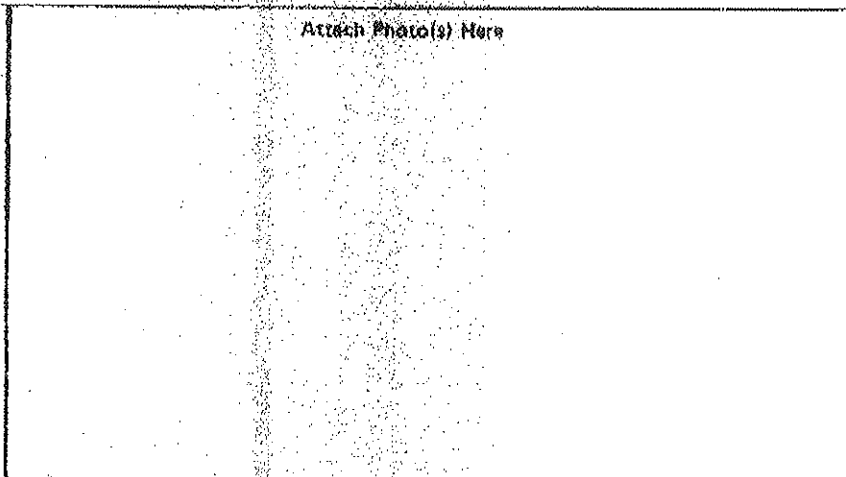

8. Construction date: Estimated _____ Factual 1903
9. Architect Hemenway S. Miller
10. Builder unknown
11. Approx. property size (in feet)
Frontage 100 Depth 25
or approx. acreage _____
12. Date(s) of enclosed photograph(s)
7/78

AT03W0-01

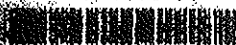

- 13. Condition: Excellent Good Fair Deteriorated No longer in existence
- 14. Alterations: ground floor remodeled
- 15. Surroundings: (Check more than one if necessary) Open land Scattered buildings Density built-up
Residential Industrial Commercial Other: edge of Yerba Buena
- 16. Threats to site: None known Private development Zoning Vandalism
Public Works project Other:
- 17. Is the structure: On its original site? Moved? Unknown?
- 18. Related features:

SIGNIFICANCE

19. Briefly state historical and/or architectural importance (include dates, events, and persons associated with the site.)

This is a fine example of a three part Sullivanesque composition, designed by a little-known firm, Hemenway and Miller, who also did the excellent original design for the building now known as the old French Bank (108-110 Sutter). The glass base of the structure was designed to relate to the form of the San Francisco type with glass commercial areas under "architectural" office floors.

The building serves as a powerful corner anchor, although the buildings which it once anchored have all been demolished for the Yerba Buena Center.

The Aronson Building achieved a measure of notoriety in the post-fire report of the U.S. Geological Survey on the condition of San Francisco buildings. It was the report's featured example of supposedly fireproof construction that met with disaster. The building was built by Abraham Aronson, a major real estate investor of the period and an active member of the Jewish community. The building is said to be the first in the city named after a Jewish person.

- 20. Main theme of the historic resource: (If more than one is checked, number in order of importance.)
Architecture Arts & Leisure
Economic/Industrial Exploration/Settlement
Government Military
Religion Social/Education

- 21. Sources (List books, documents, surveys, personal interviews and their dates).
Sanborn Map, SF Reallex, 1976
Arch&Eng May 1906, USGS #324
SF Architectural Club Notebook 1903/4
Waver, Western Jewry p. 165

- 22. Date form prepared 3/28
By (name) _____
Organization Charles Hall Fire Assn.
Address 354 Bush
City San Francisco zip 94104
Phone: (415) 382-1151

Locational sketch map (draw and label site and surrounding streets, roads, and prominent landmarks):



DETERMINATION OF ELIGIBILITY
NOTIFICATION FOR THE
NATIONAL REGISTER OF
HISTORIC PLACES
1978

PRIM# 38-000480

Prop# 006030
NPS-65000559-9999

RECEIVED
NOV 26 2007
OHP

E.O. 11593

DETERMINATION OF ELIGIBILITY
Date received 3/27/78
Federal Register entry

Property The Aronson Historic District

City San Francisco State California

Source of Request HUD Tad Masaoka

Photos X SHPO consulted yes-eligible
Maps X Request for more information _____
Card filed _____ All documentation assembled _____

CONTROL

In an entity the 3 bldgs represent the "City Beautiful" commercial block architecture popular in the early 20th c. They are significant in the "South of Market" San Francisco history.

HISTORIAN
Eligible
Markham
3-30-78

*3 buildings eligible as a group 2-7-906
merchandise individually eligible.*

ARCH. HISTORIAN
Eligible
Parvham
3-28-78

ARCHEOLOGIST

HAER

REVIEW UNIT CHIEF

FED. PLAN. COORDINATOR

Eligible
Cshull
5-1-78

BRANCH CHIEF

Eligible
Cshull for
Cherington
5-1-78

KEEPER

E.O. 11593

DETERMINATION OF ELIGIBILITY NOTIFICATION NATIONAL REGISTER OF HISTORIC PLACES OFFICE OF ARCHEOLOGY AND HISTORIC PRESERVATION HERITAGE CONSERVATION AND RECREATION SERVICE

Request submitted by: WON Ted Masaoka

Date request received: 3/27/78

Name of property: The Aronson Historic District State: California

Location: 693, 710 Mission Street, 87 Third Street; San Francisco

Opinion of the State Historic Preservation Officer:

Eligible Not eligible No response

Comments: "....Eligible for inclusion in the National Register of Historic Places."

The Secretary of the Interior has determined that this property is:

Eligible Applicable criteria: c

Comments: 693, 710 Mission Street, and 87 Third Street, are interesting examples of multi-story commercial architecture typical of the early 20th century. They are significant as a group, preserving a whole commercial corner essentially as it was originally. In addition, 710 Mission Street is individually eligible for its design which is reminiscent of Louis Sullivan's skyscrapers in Chicago.

Not eligible

Comments:

Documentation insufficient (see accompanying sheet explaining additional materials required)

Robert B. Pettig (Sgd.)

Keeper of the National Register

Date: MAY 02 1978

HUD Analysis to Determine Eligibility of an Historic District
for Inclusion in the National Register

NAME: No name exists for this proposal. However, the Mercantile Building is the dominating structure and in recognition of its original and longtime owner, A. Aronson,* it is suggested that the name be "The Aronson Historic District".

LOCATION: Three corners of Third and Mission Streets, San Francisco. Please see attached map.

DESCRIPTION: The northwest, southeast, and northeast corners of these two streets each contains a structure which has been analysed as individual building at 710 Mission Street, 693 Mission Street, and 87 Third Street respectively. Each has been found lacking in significance by HUD to be found eligible for inclusion in the National Register. However, as a group these three buildings are eligible for inclusion as an historic district.

Prof. Turner has suggested the significance of this group of buildings by commenting as follows: "These three buildings, all built soon after the 1906 fire, are interesting examples of commercial architecture of the period, but are probably less significant individually than they are as a whole (that is, as an urbanistic ensemble, preserving a whole commercial corner essentially as it was originally.) Individually, the two most interesting of the buildings, in my opinion, are: 710 Mission (the N-W corner), with its richly ornamented upper stories; and the simpler building on the N-E corner, with its wide "Chicago window" proportions, and its unusual iron brackets at the fifth floor level."

The Aronson building (now known as the Mercantile building) was impressively designed to dominate its corner and the buildings around it in the concentration of mass and detail at the top. Virtually everything else in the immediate neighborhood was built at the same time, but few structures were as elaborate. The building thus dominated its corner by effectively combining traditional design elements more commonly found in the better neighborhoods north of Market Street, with more purely functional qualities of the south of Market area. It thus dominates the other two structures at this intersection of Third and Mission Streets, and together with them creates a unique and impressive example of the early century City Beautiful movement type development.

HUD FINDINGS: In spite of HUD finding that the architectural style of each building does not embody the distinctive characteristics of a type, period, or method of construction, HUD finds that as a group, the three buildings do represent a significant and distinguishable entity whose component parts lack individual distinction. And that as a group, the buildings are associated with events that have made a significant contribution to the broad pattern of our San Francisco history.

The Mercantile Building, at 710 Mission Street was constructed before the 1906 earthquake, was destroyed by it, and was reconstructed thereafter. The Williams Building, at 693 Mission Street was constructed "soon" after the earthquake according to Prof. Turner. And the best evidence is that the 3 story building at 87 Third Street was built in 1911, just few years after the other two. All three are representative of the "City Beautiful" commercial block architecture popular in those days, and as such, constitute an entity significant to "South of Market" San Francisco history.

HUD RECOMMENDATION:

1. These three buildings --as a group-- are a significant entity, and
2. That an historic district, to be named The Aronson Historic District, be created and found eligible for inclusion in the National Register of Historic Places.

Comments: The Mercantile building, it has already been noted, is the subject of a land disposition agreement for sale to a designated developer. As such it will be rehabilitated. The other two buildings at 87 Third Street and at 693 Mission Street are now owned by the Redevelopment Agency and scheduled to be razed.

It is noted also that the National Trust for Historic Preservation, and the San Francisco Landmark Advisory Board have recommended that this area, (without defining the "area") be preserved as an example of period development. HUD has reviewed the possibilities involved in defining the area, and concludes that the subject three buildings only should be included in the district. The nearby Jessie Substation, a National Register property, does not contribute to the value of the District because of its different romanesque style, and because it pre-dates the period represented in the District. St. Patrick church, some 300' west of the Mercantile building also is not representative of either the period or the architectural style. It is a unique structure best listed in the Register as a single building. The Jessie Hotel is not included because its location contributes nothing to the value of the District, which value is derived from the very fact that the three buildings are in three adjoining corners, and as such constitute a significant entity.

*The Aronson Building was erected as a commercial office building by Abraham Aronson. Mr. Aronson was a Polish immigrant who came to San Francisco in 1870 and who became successful in the furniture business. He was an active leader in the Jewish community and helped finance the Stockton Street Synagogue in 1886. After 1894 he was engaged exclusively in the real estate business, buying old buildings and sites and building modern structures in their places. Like other developers, he was especially busy in the period following the earthquake and fire of 1906, and by 1916 had become one of the more prolific commercial builders in the City. Like other important San Franciscans such as Mr. Flood and Mr. Phelan, Mr. Aronson gave permanent recognition to his success by building a large office block in his own name, the first Jewish person to do so in San Francisco. This building, located at the northwest corner of Third and Mission Streets, remained in family ownership until 1938 when it was sold to the Northwestern Mutual Life Insurance Company and became known as the Mercantile Building.

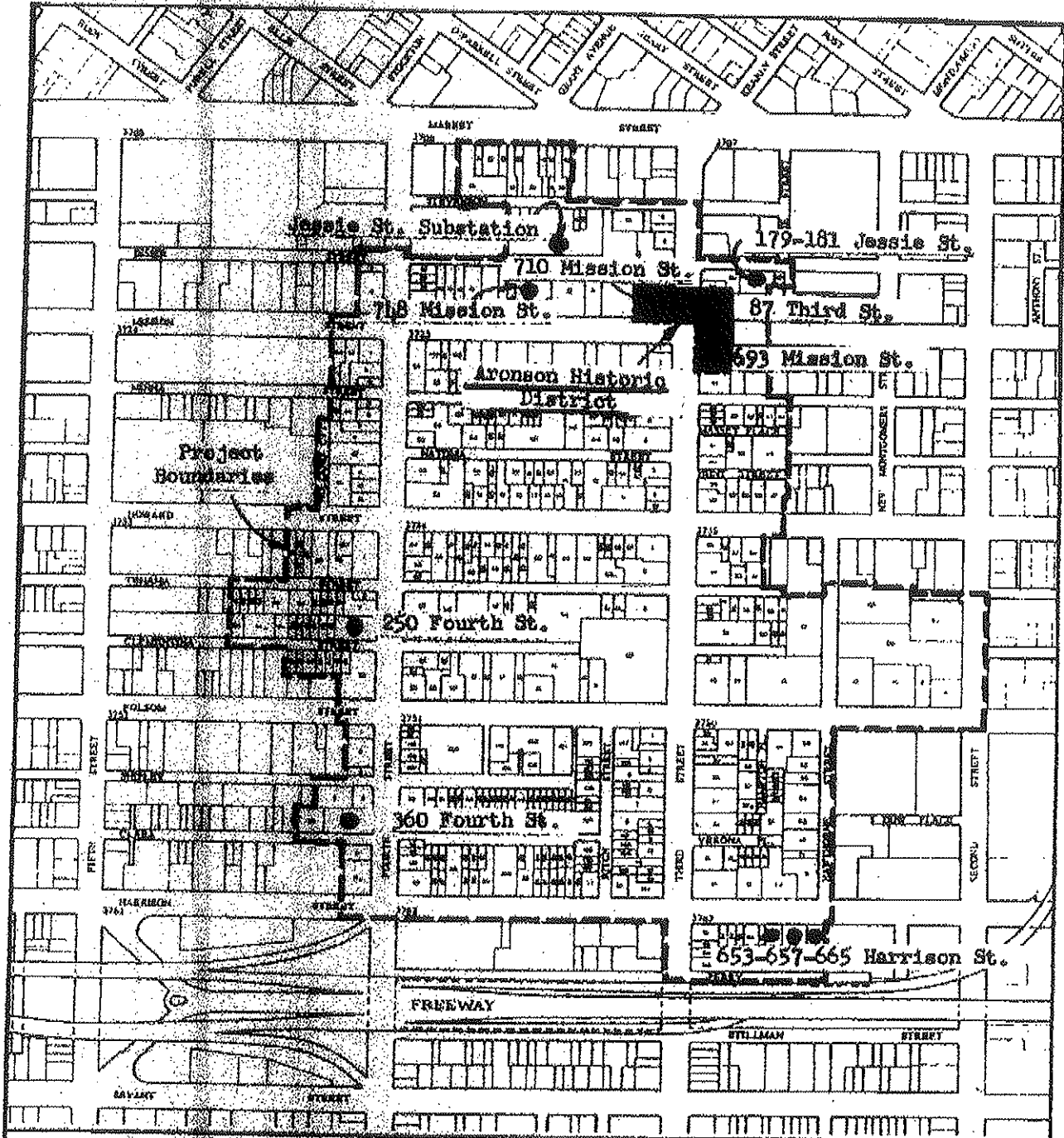

YERBA BUENA CENTER

REDEVELOPMENT PROJECT AREA D-1

PROJECT AREA BOUNDARIES

AND SHOWING BUILDINGS HAVING HISTORIC
OR ARCHITECTURAL INTEREST & VALUE

- PROJECT AREA BOUNDARY
- 3700 ASSessor'S BLOCK NUMBER
- [] LOT NUMBER

PREPARED BY SAN FRANCISCO HUD AREA OFFICE * ENVIRONMENTAL STAFF

1/78



HISTORIC DRAWINGS
C. 1906 GLADDING MCBEAN
TERRA COTTA SHOP DRAWINGS

TOTAL LIST OF TERRA COTTA		
E1 TO 5	1 TO 18 EACH	90 PIECES
E6 TO 9	1 TO 18 EACH	72
FOR E STORY TOTAL		162 PIECES
F		162
G		162
H		162
I		90
TOTAL		738 PIECES

ORDER 717 E.F.G.H. [OLD ORDER 591] DNR 11014 SCALE 3/4"=1'-0"

TERRA COTTA FOR 5TH 6TH 7TH 8TH & 9TH STORIES

SCHEDULE DRAWING AND SETTERS DIAGRAM FOR

THE ARONSON BUILDING SAN FRANCISCO

HEMENWAY & MILLER ARCHITECTS
J.S. 702

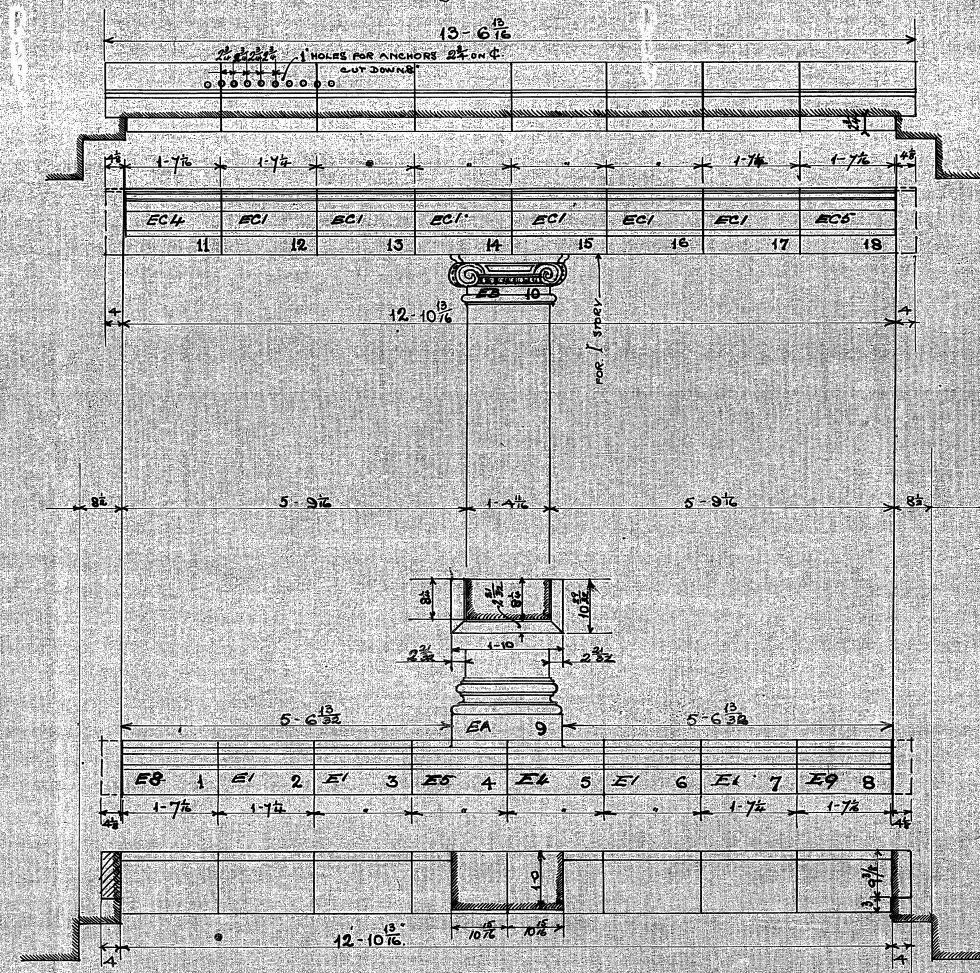
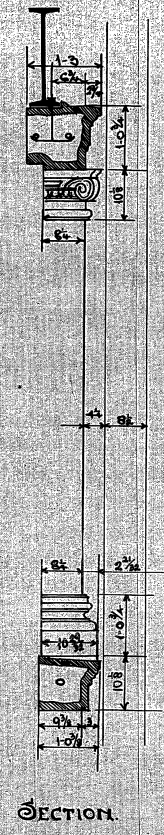
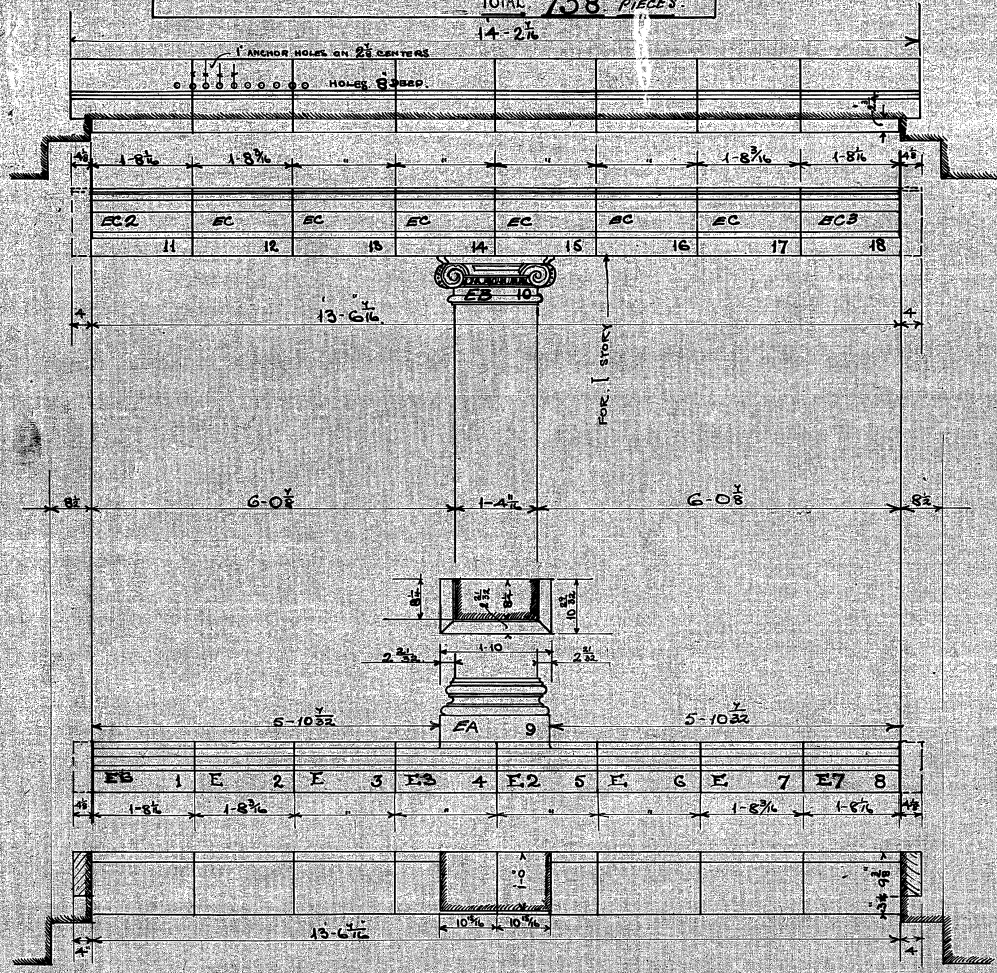

MISSION ST ELEVATION		
E.1 TO 5.	1 TO 18 EACH	
F.1 TO 5.		
G.1 TO 5.		
H.1 TO 5.		
I.1 TO 5.	1 TO 10	

THIRD ST ELEVATION		
E6 TO 9	1 TO 18 EACH	
F6 TO 9		
G6 TO 9		
H6 TO 9		
I6 TO 9	1 TO 10	

ORDER 77 D (ORDER 59) DRG 17014. SCALE 3/4-1-0

SCHEDULE DRAWING AND SETTEK'S DIAGRAM FOR

THE ARONSON BUILDING SAN FRANCISCO

HEMPWAY & MILLER ARCHITECTS

TOTAL LIST OF TERRA COTTA

D1.	1 TO 9	9 PIECES
D2,4,6,8,10.	1 TO 10 EACH	50
D3,5,7,9,13,15,17.	1 TO 7 EACH	49
D11.	1 TO 12	12
D12,14,16,18.	1 TO 10 EACH	40
D19.	1 TO 7	7
		TOTAL 167 PIECES

TERRA COTTA FOR 4TH STORY :-

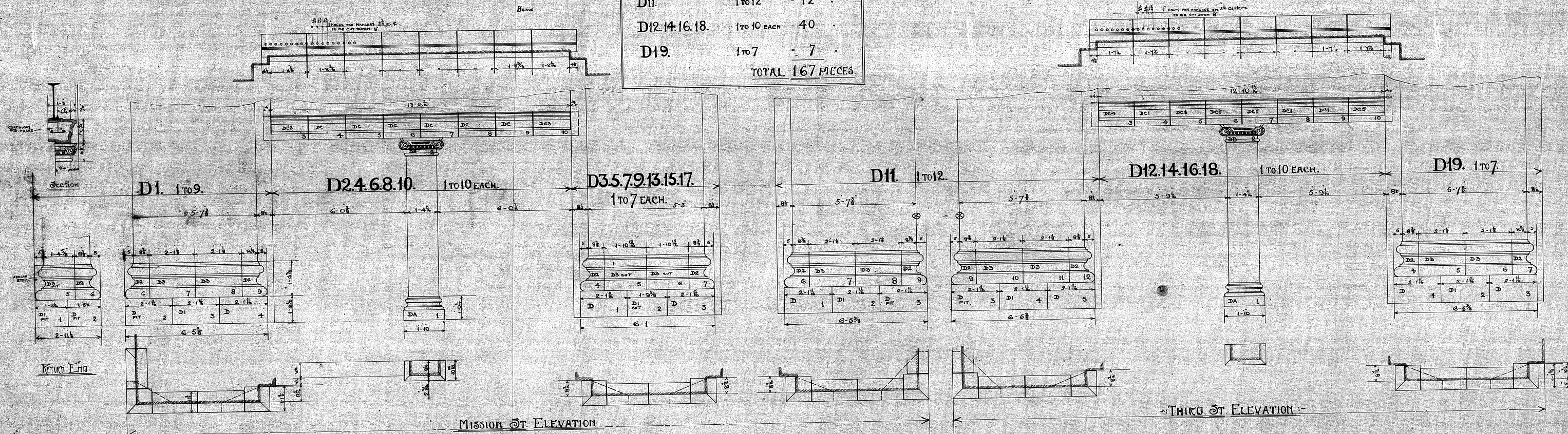

HISTORIC DRAWINGS
1978 ADDITION PROJECT
SELECT ARCHITECTURAL
DRAWINGS

ASPHALT PARKING LOT

NOTES
 Surveyed in accordance with Western Title Insurance Company Preliminary Report No. 597962 PLA, dated 7-13-81.
 For the purpose of clarity, location of improvements are not shown to scale.
 All property line angles are 90°.
 Basement Sidewalk Vault Area has fire sprinklers.

DESCRIPTION
 BEGINNING at the point of intersection of the northwesterly line of Mission Street and the southwesterly line of Third Street, on said streets as shown on that certain map entitled "Record of Survey Map of Yerba Buena Center Central Blocks", recorded February 19, 1975, in Book "V" of Maps, of pages 102 and 103, in the Office of the Recorder of the City and County of San Francisco, State of California; running thence southwesterly along said northwesterly line of Mission Street 147 feet; thence at a right angle northwesterly 105 feet; thence at a right angle northwesterly 147 feet to the southwesterly line of Third Street; thence at a right angle southeasterly along said southwesterly line of Third Street 105 feet to the point of beginning.

BEING a portion of 100 Vera Block No. 362, and a portion of Opera Alley, vacated by Resolution No. 106-75, adopted February 3, 1975, by the Board of Supervisors of the City and County of San Francisco, State of California.

SURVEYOR'S CERTIFICATE
 I hereby certify that the survey prepared by me entitled "Survey for T/W Associates" was actually made upon the ground and that it and the information, courses and distances shown thereon are correct; that the title lines and lines of actual possession are the same; that the size, location and type of buildings and improvements as shown and all are within the boundary lines of the property, other than those shown and depicted thereon; that there are no violations of zoning ordinances, restrictions or other rules and regulations with reference to the location of said buildings and improvements; that there are no easements, encroachments or uses affecting this property appearing from a careful physical inspection of the same, other than those shown and depicted thereon; that all utility services required for the operation of the premises either enter the premises through adjoining public streets or the survey shows the point of entry and location of any utilities which pass through or are located on adjoining private land; that the survey shows the location and direction of all storm drainage systems for the collection and disposal of all roof and surface drainage; that any discharge into streams, rivers or other conveyance system is shown on the survey; and that the parcel described hereon does not lie within flood hazard areas in accordance with the document entitled "Department of Housing and Urban Development, Federal Insurance Administration - Special Flood Hazard Area Maps". This survey is made in accordance with the Minimum Standard Detail Requirements for Land Title Surveys jointly established and adopted by ALTA and ACSM in 1982.



Gordon V. Tronoff
 July 30, 1981

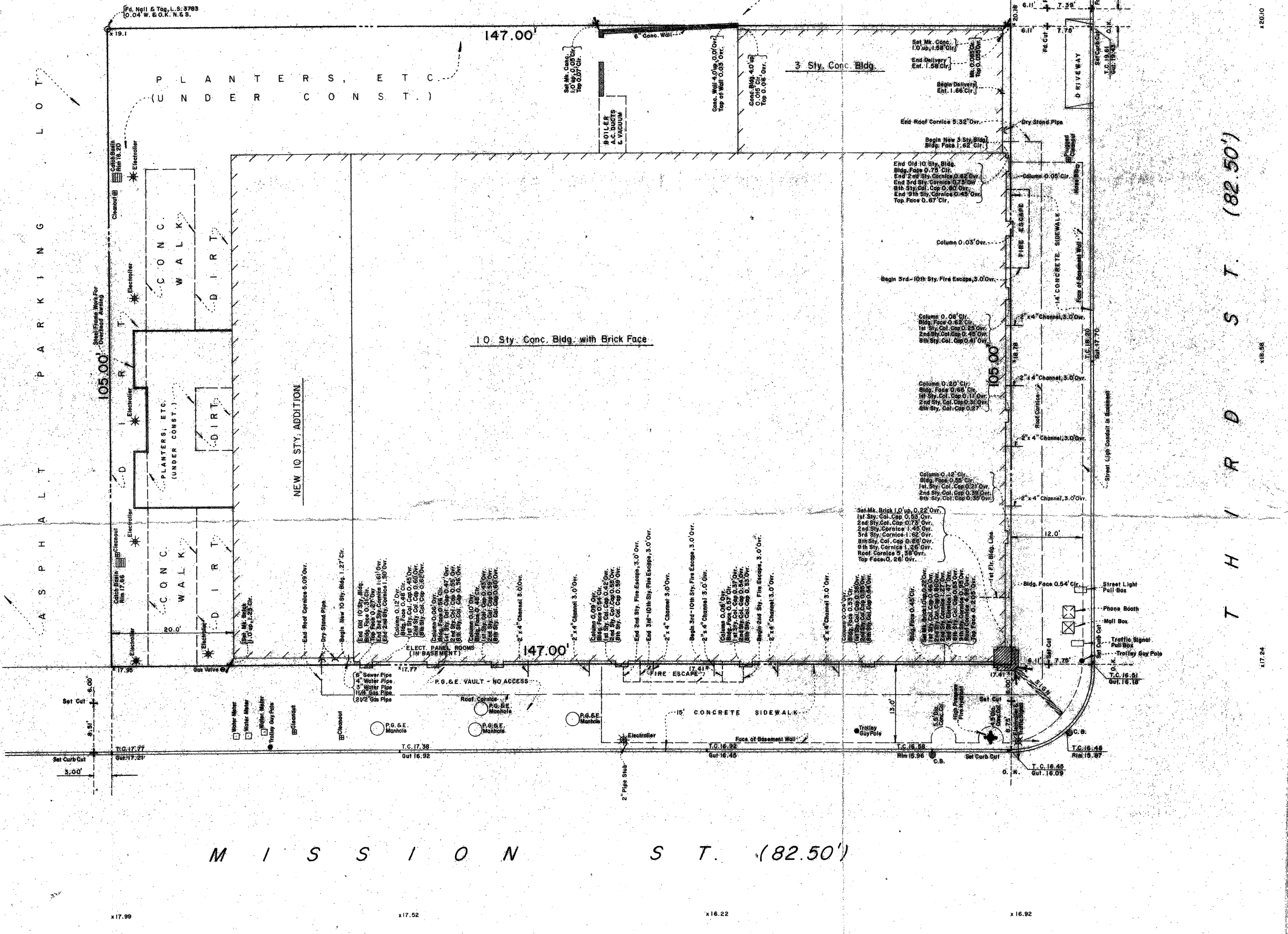

MISSION ST. (82.50')

THIRD ST. (82.50')

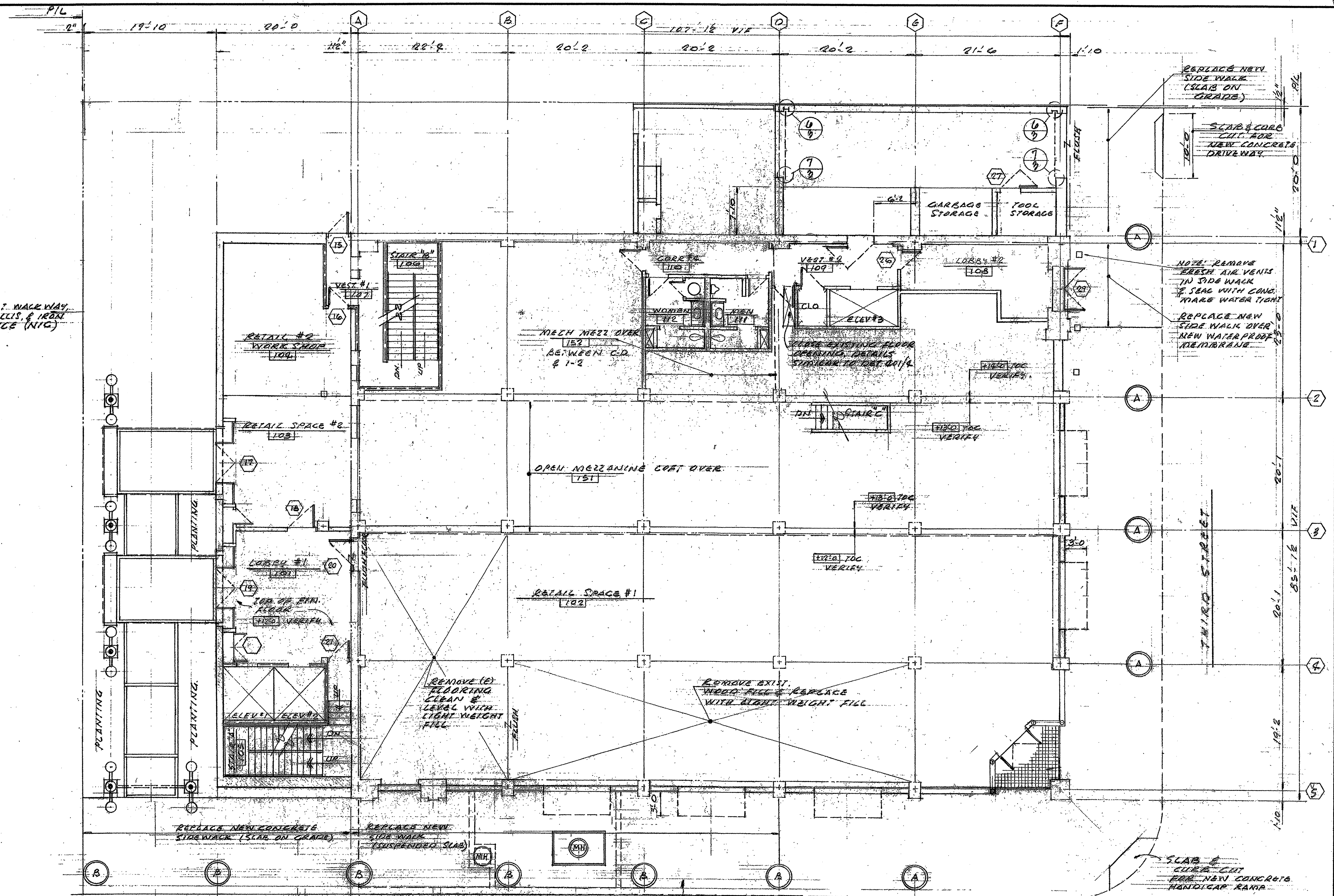
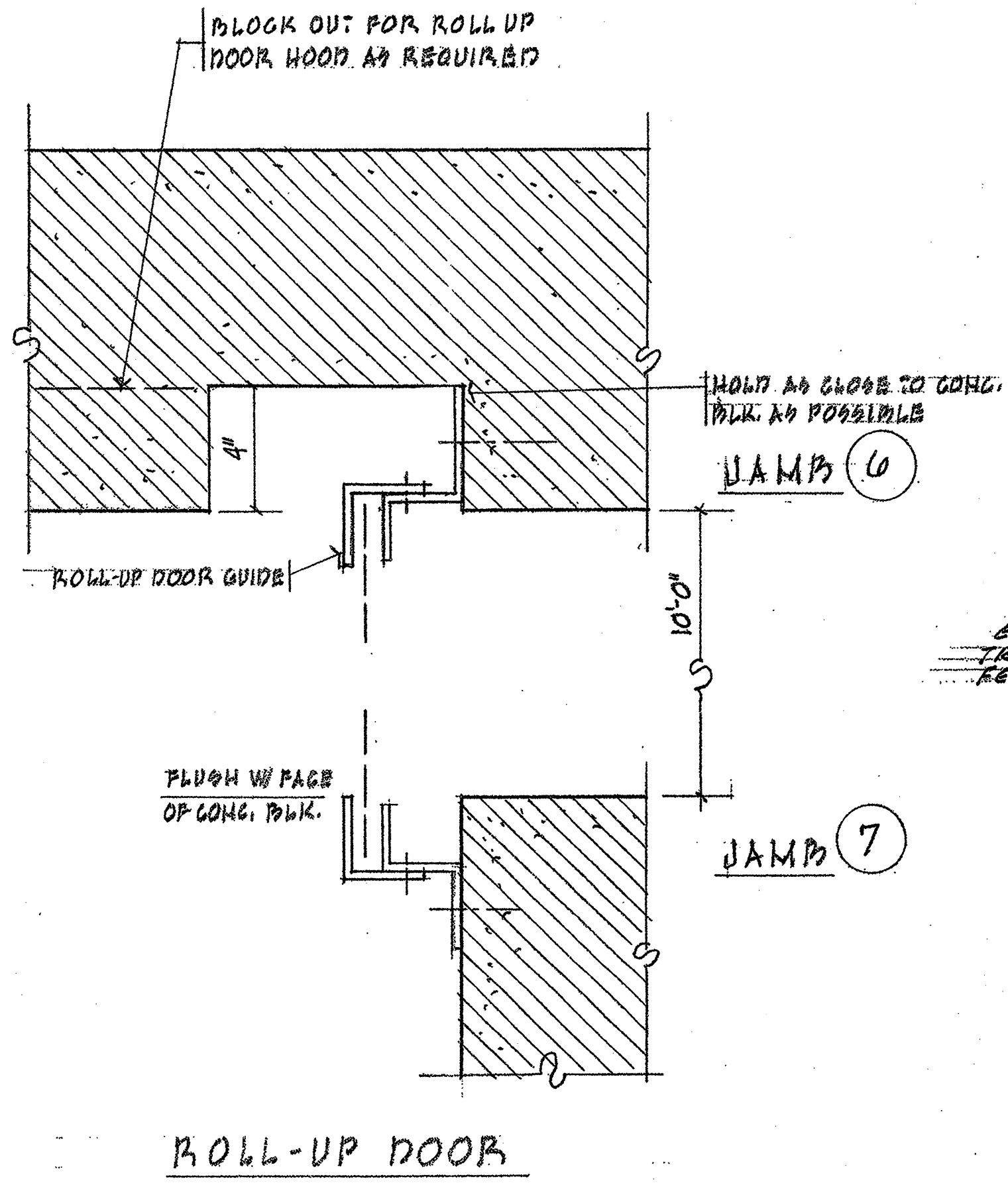

FLOOR ELEVATION
 GROUND FLOOR +12'-0", +13'-0", +14'-0"
 MISSION STREET
 GROUND FLOOR PLAN
 56'-8" x 150'

PLANTING NOTES (NIC)
 (A) PLANT TYPE A: MAGNOLIA GRANDIFLORA "RUSSET"
 (B) PLANT TYPE B: MAGNOLIA GRANDIFLORA "SAMUEL SOMMER"

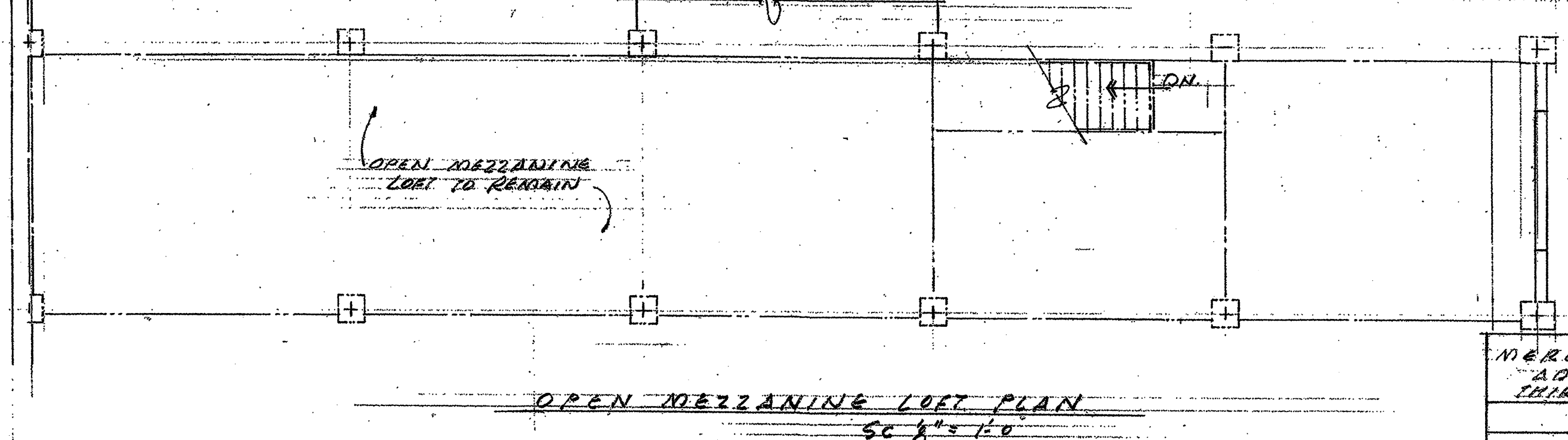

MERCANTILE CENTER BUILDING
 ADDITIONS & REHABILITATION
 THIRD & MISSION STREET, SAN FRANCISCO, CA
 0-26-99
 5/31/98
 T/W ASSOCIATES
 390 - FOURTH STREET, SAN FRANCISCO, CA
 WORKS CIVIL & STRUCTURAL ENGINEERS
 380 FOURTH ST. SAN FRANCISCO, CA. 94102

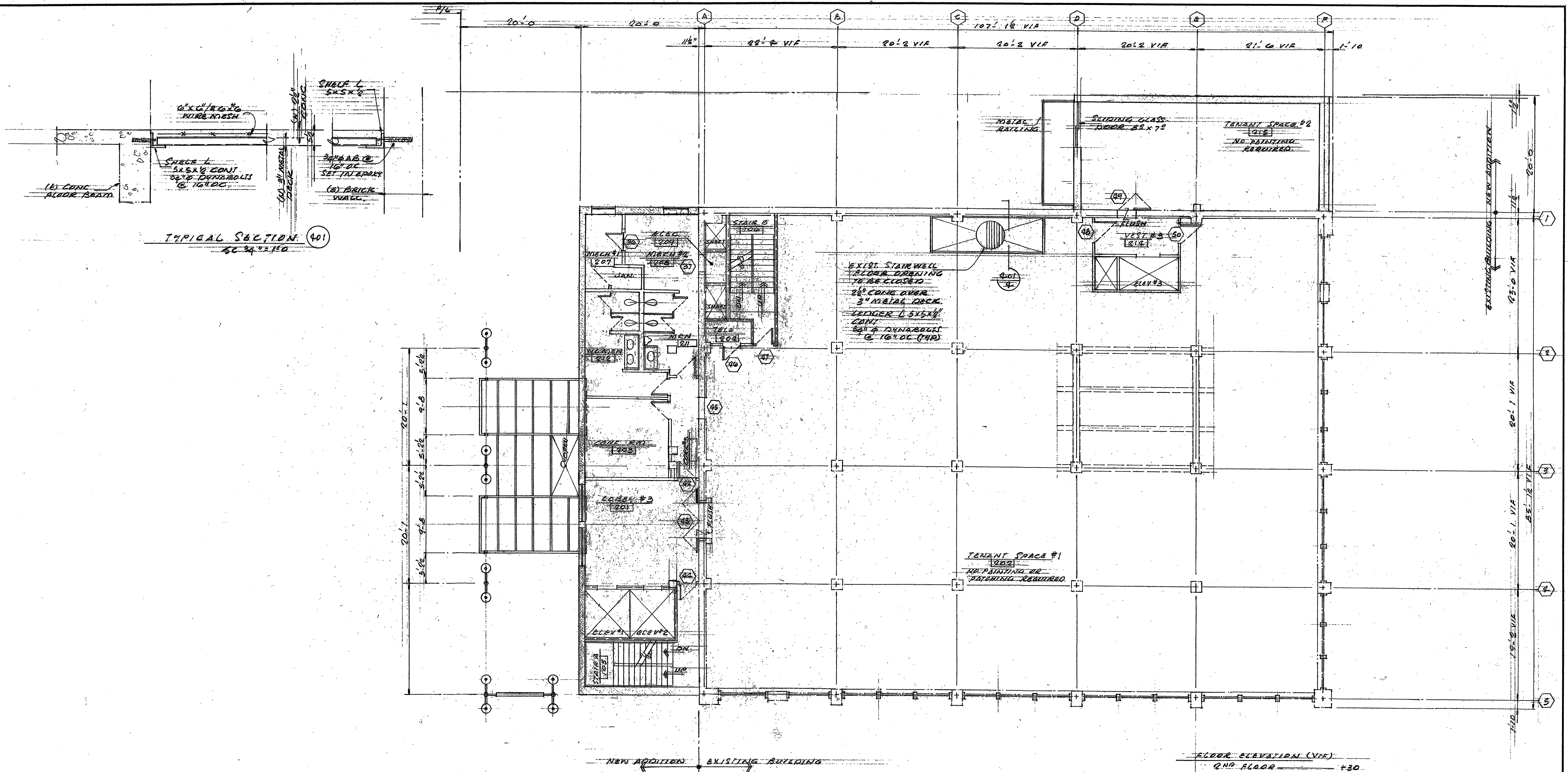

TYPICAL SECTION 401
SC 84-110

SECOND FLOOR PLAN
SC 8-110

FLOOR ELEVATION (VIB)
2ND FLOOR +30

NOTES
SEE SHEET 10 FOR WALL AND PARTITION LEGEND.
SEE SHEET 10 FOR 1/4" SCALE PLAN

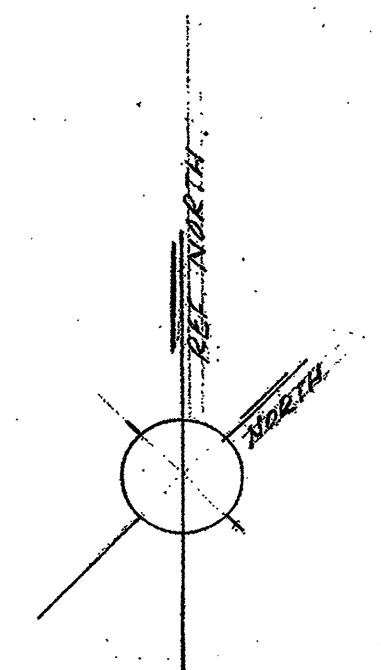

MERCANTILE CENTER BUILDING
ADDITIONS & REHABILITATION
THIRD & MISSION STREET, SAN FRANCISCO, CA
1/14 ASSOCIATES
390 FOURTH STREET, SAN FRANCISCO, CA
4

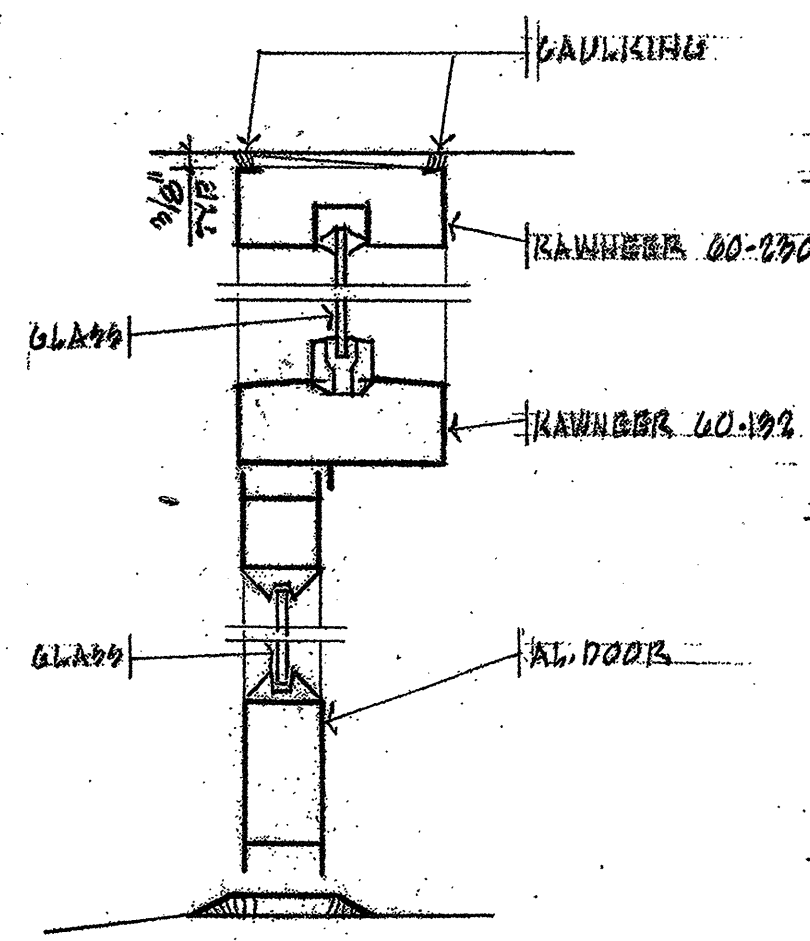

HEAD 15

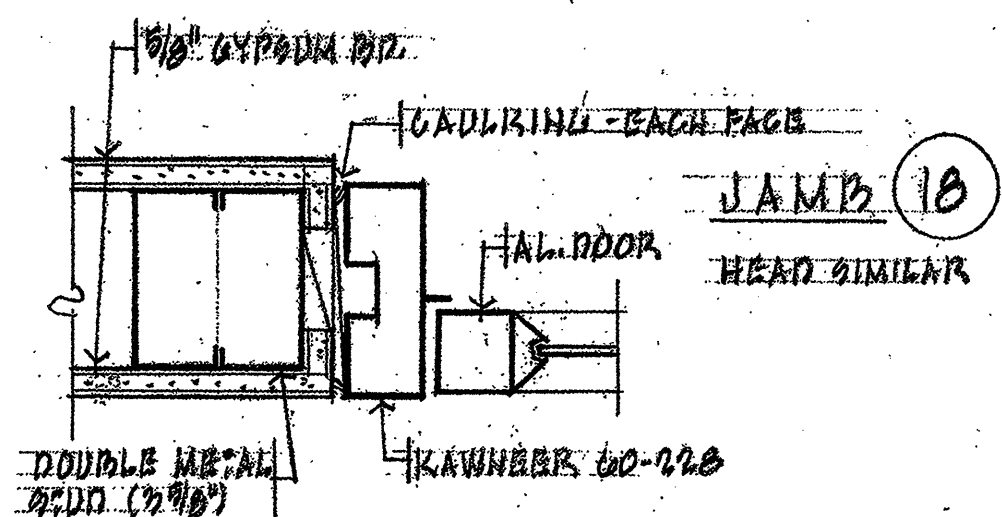

JAMB 18

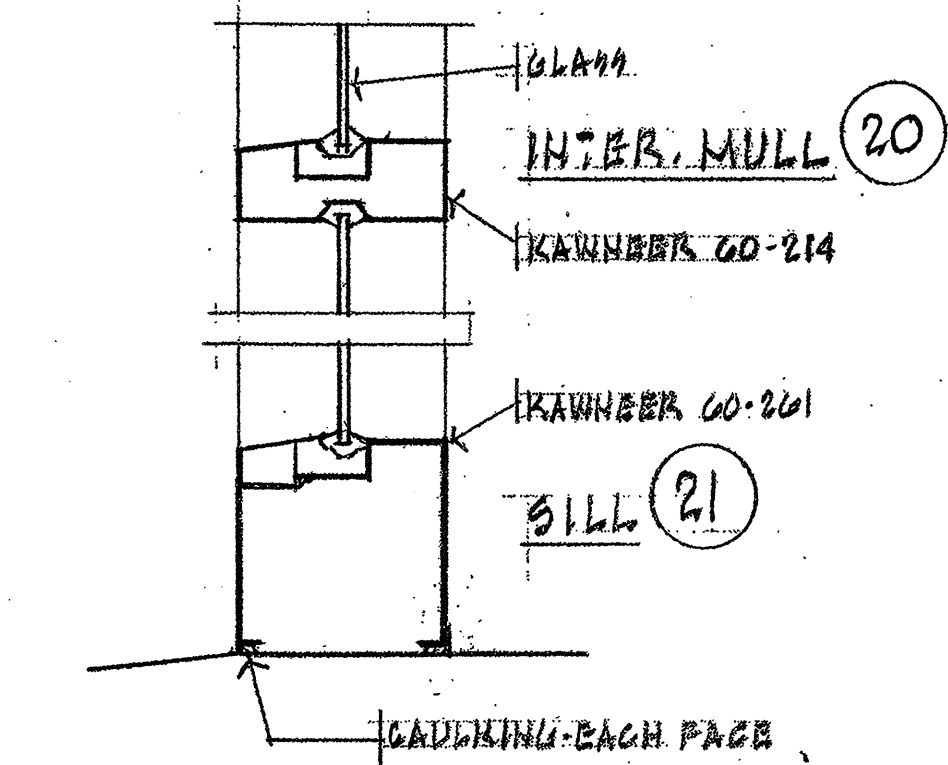

INTER. MULL 20

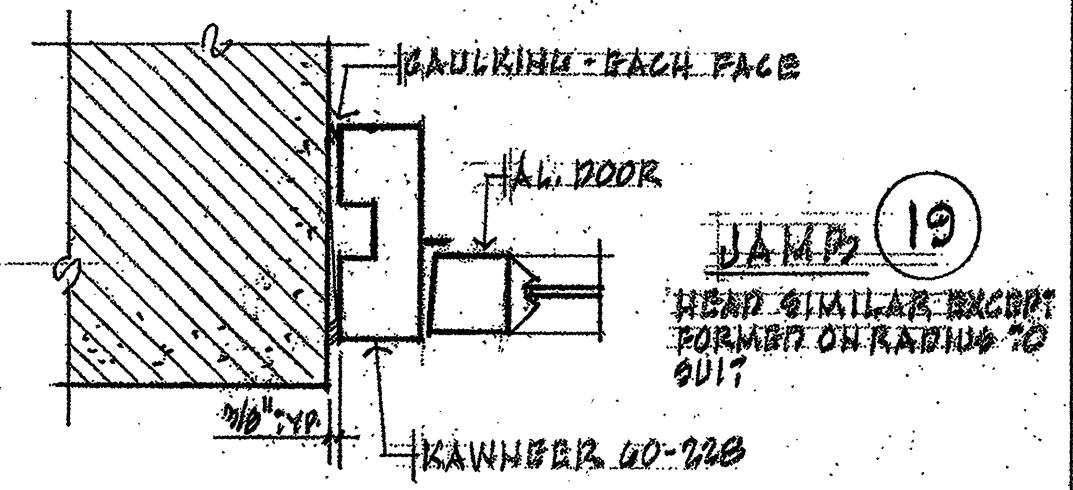

JAMB 19

SILL 17

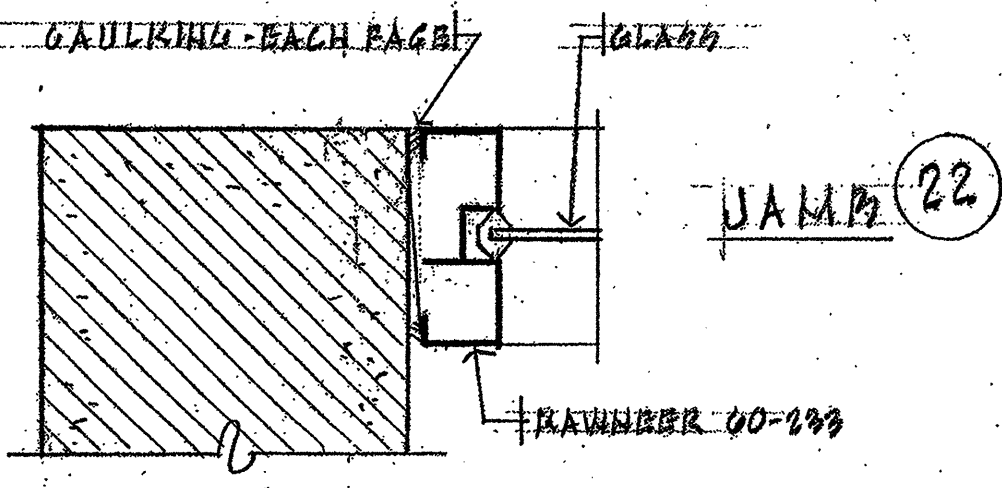

JAMB 22

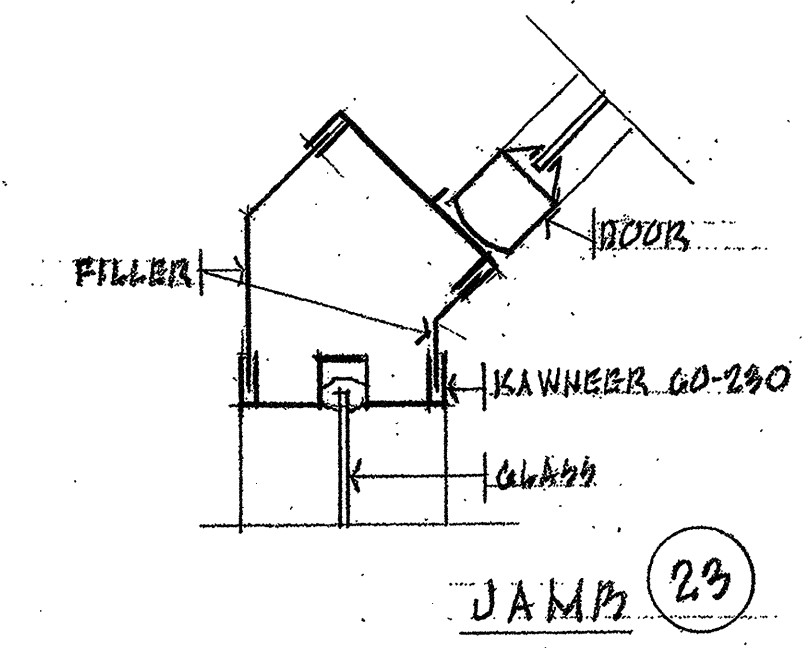

JAMB 23

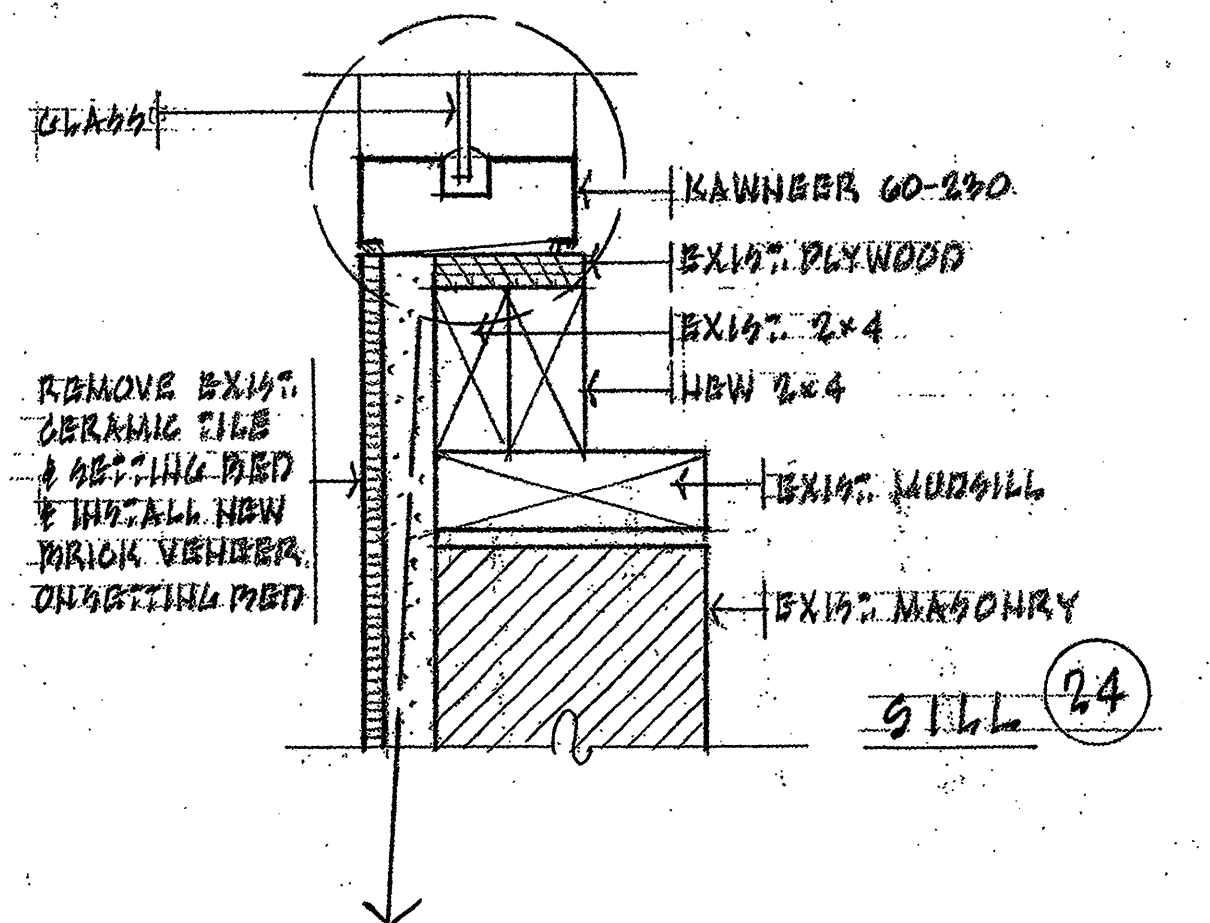

SILL 24

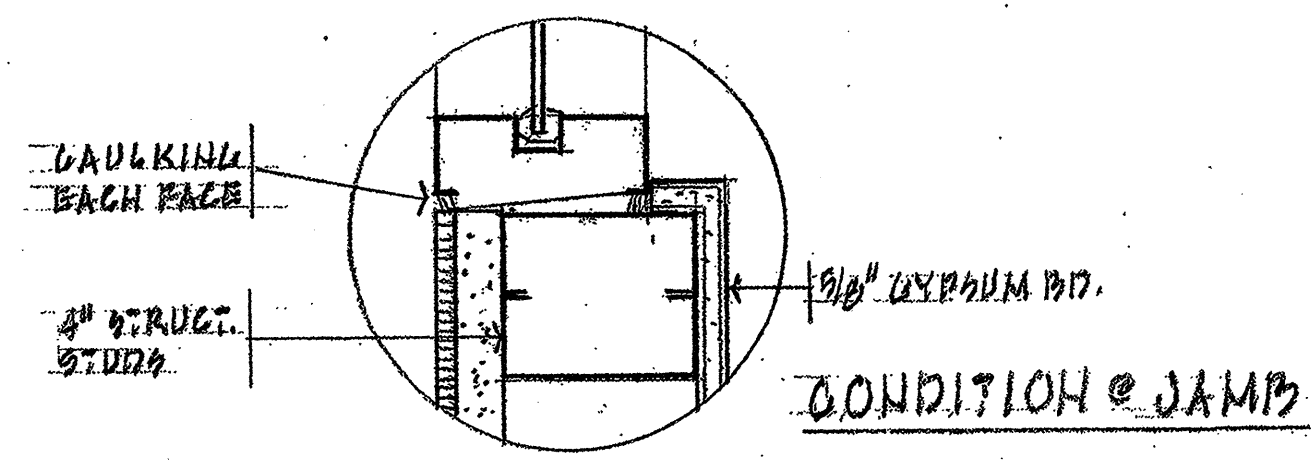

CONDITION @ JAMB

STOREFRONT DETAILS 2"=1'-0"

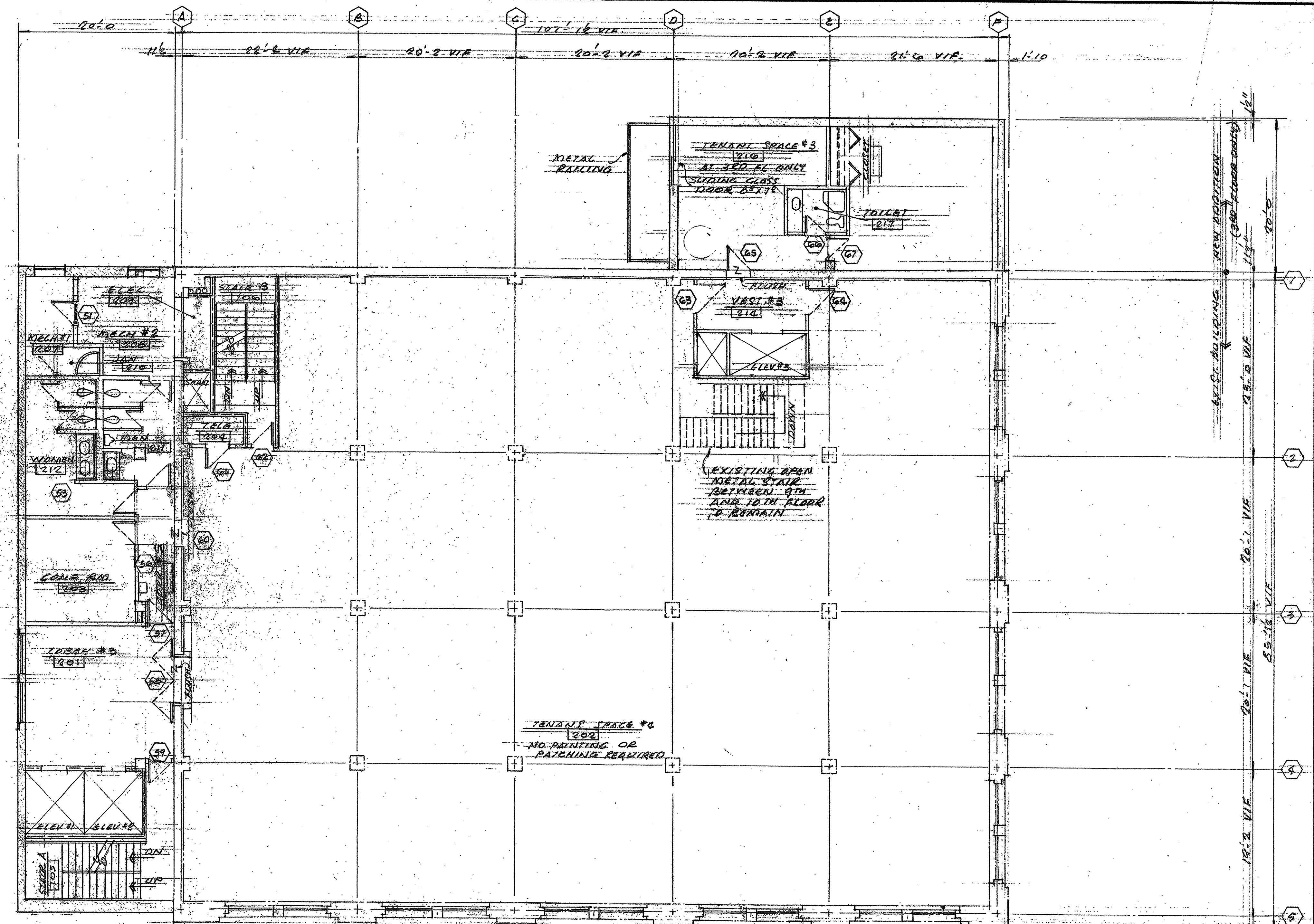

FLOOR ELEVATIONS (VIE)

10 TH FLOOR	+136
9 TH FLOOR	+122
8 TH FLOOR	+109
7 TH FLOOR	+96
6 TH FLOOR	+83
5 TH FLOOR	+70
4 TH FLOOR	+57
3 RD FLOOR	+44

NOTE: SEE SHEET 10 FOR 1/4" SCALE PLAN AND WALL & PARTITION LEGEND.

TYPICAL FLOOR PLAN (THIRD THRU TENTH) 1/4" = 1'-0"

MERCANTILE CENTER BUILDING
 ADDITIONS & RECONFIGURATION
 THIRD & MISSION STREETS, SAN FRANCISCO, CA

12-26579
 5/31/78

T/W ASSOCIATES
 390 - FOURTH STREET, SAN FRANCISCO, CA

CIVIL & STRUCTURAL ENGINEER
 390 FOURTH ST. SAN FRANCISCO, CALIF. 94107

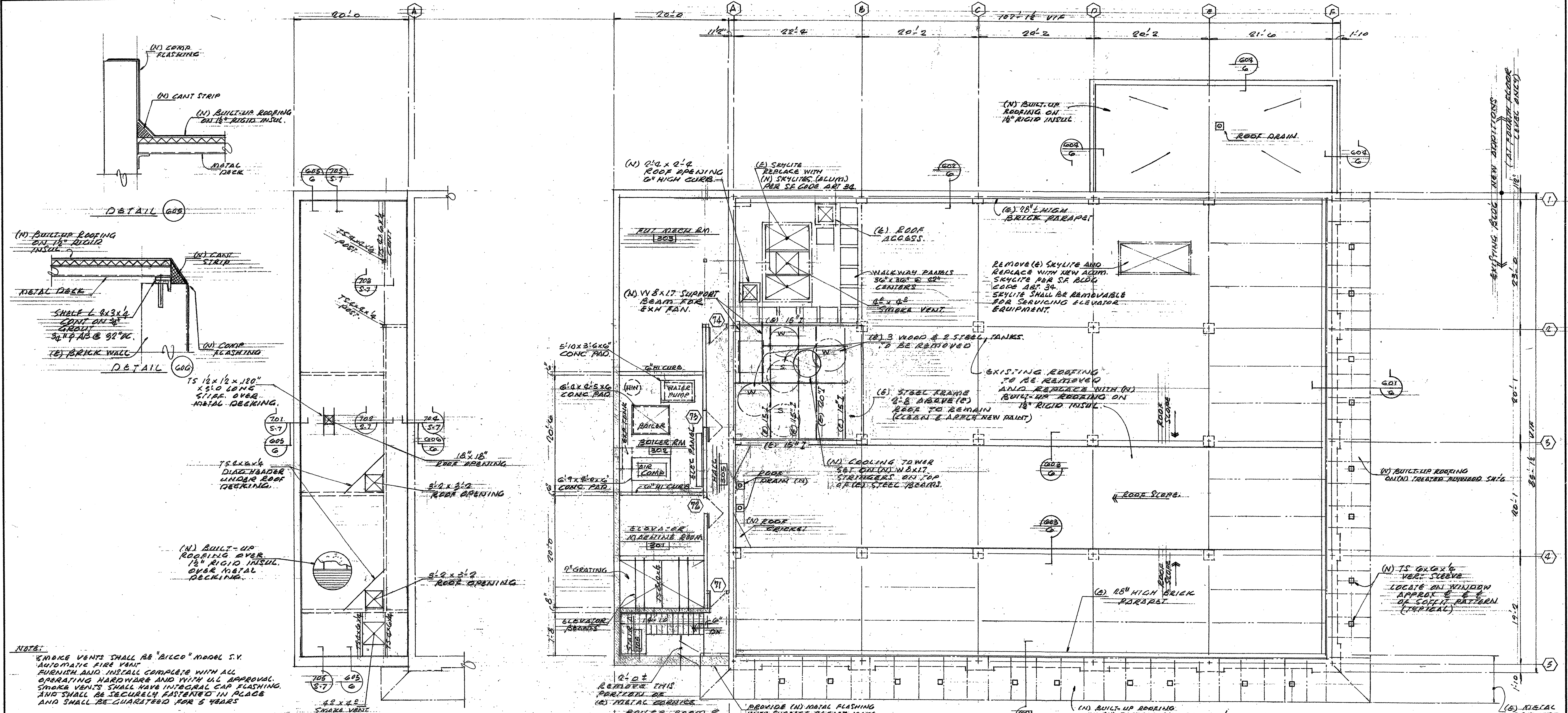

NOTE:
 SMOKE VENTS SHALL BE "BILCO" MODEL S.V. AUTOMATIC FIRE VENT. FURNISH AND INSTALL COMPLETE WITH ALL OPERATING HARDWARE AND WITH UL APPROVAL. SMOKE VENTS SHALL HAVE INTEGRAL CAP FLASHING AND SHALL BE SECURELY FASTENED IN PLACE AND SHALL BE GUARANTEED FOR 5 YEARS.

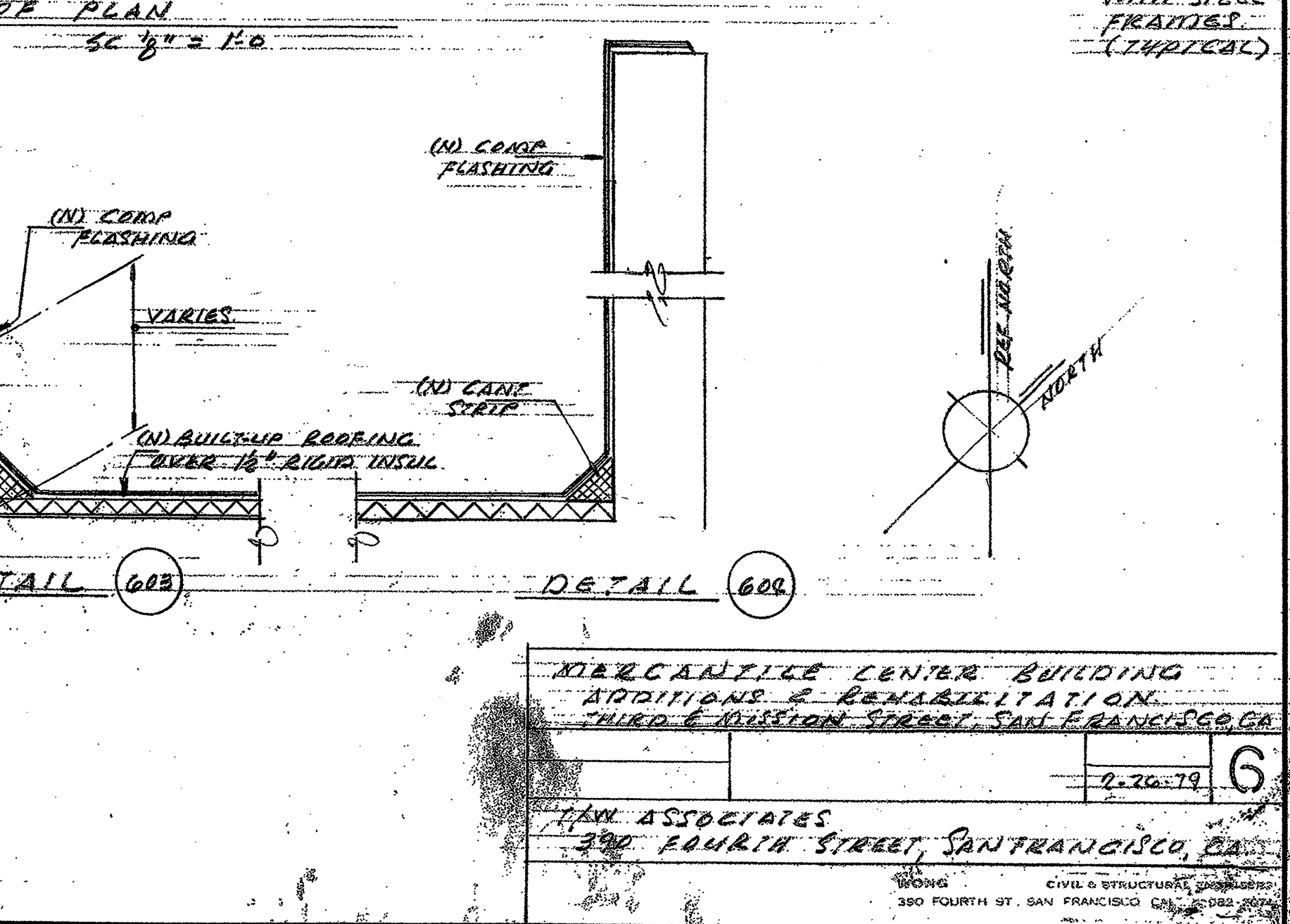
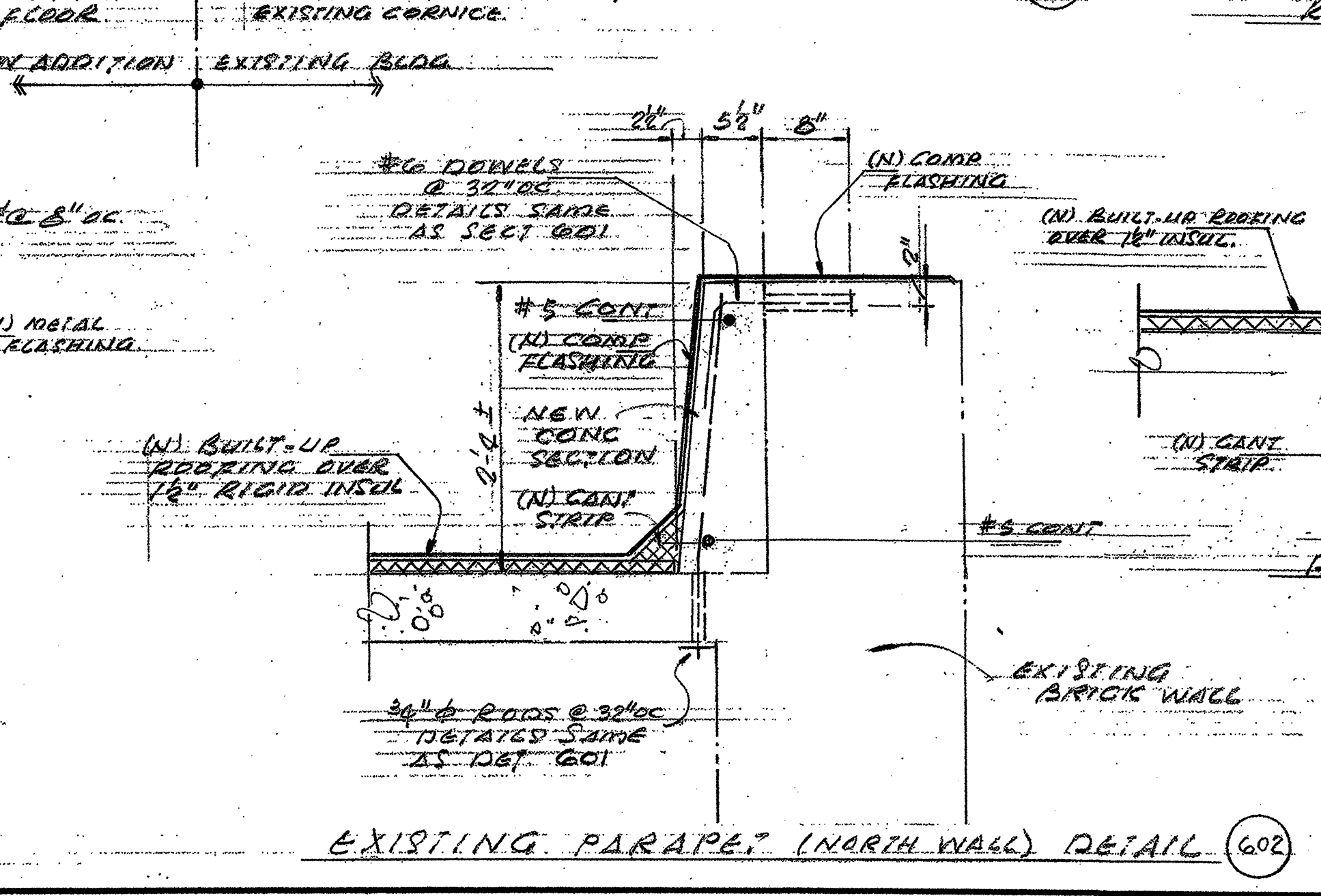
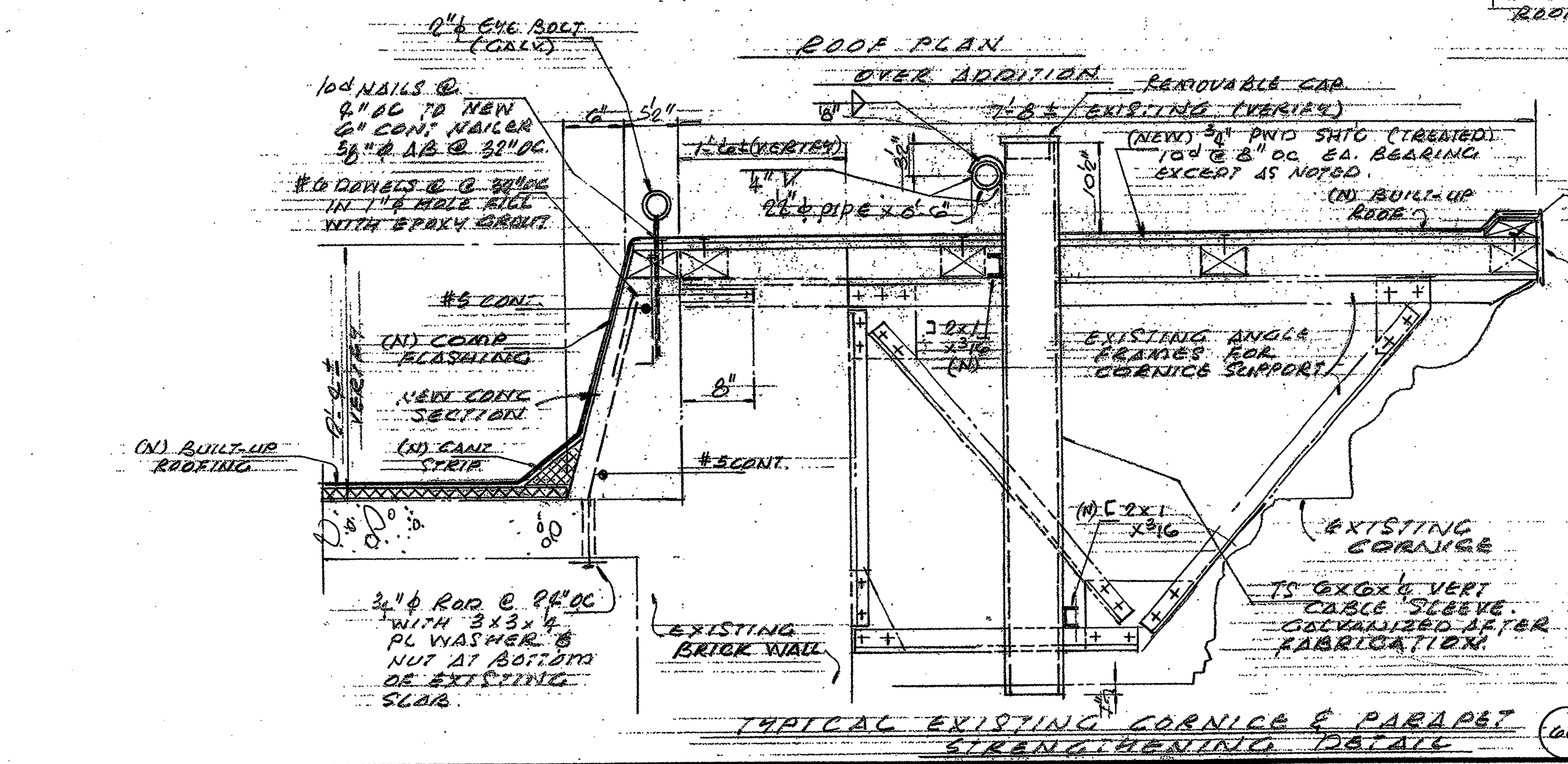

MERCANTILE CENTER BUILDING
 ADDITIONS & REMEDIATION
 THIRD & MISSION STREET, SAN FRANCISCO, CA
 2.26.79
 HAN ASSOCIATES
 300 FOURTH STREET, SAN FRANCISCO, CA
 CIVIL & STRUCTURAL ENGINEERS

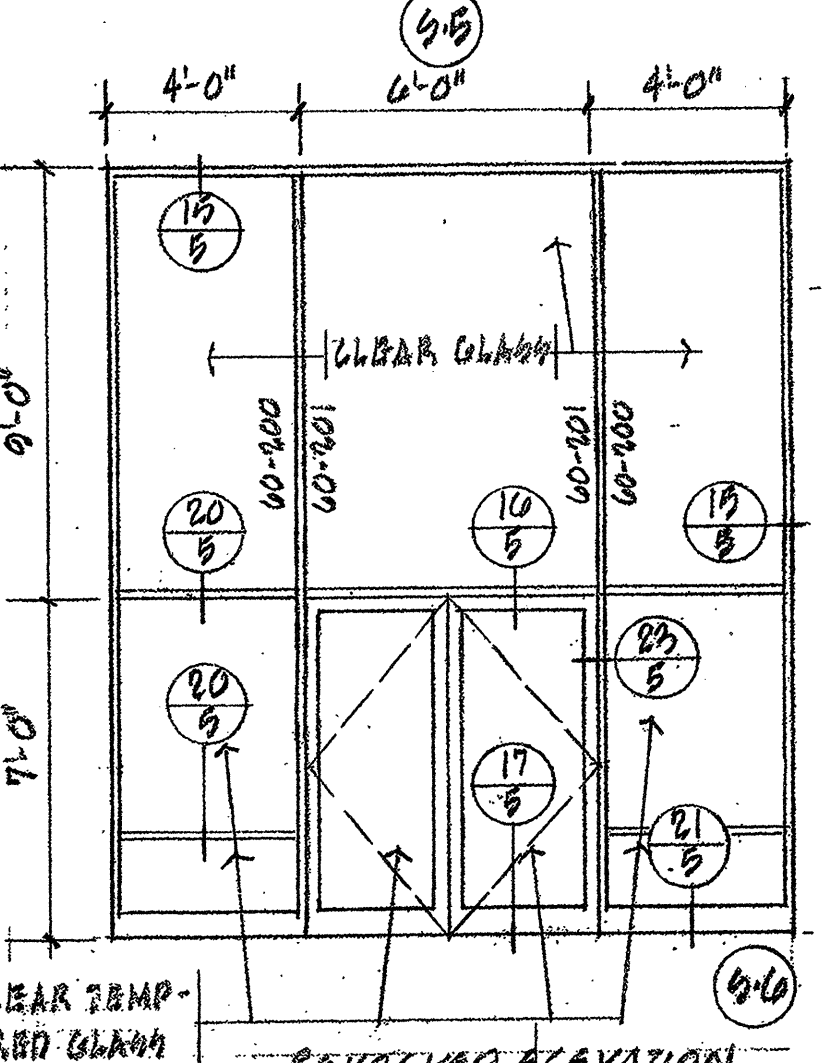
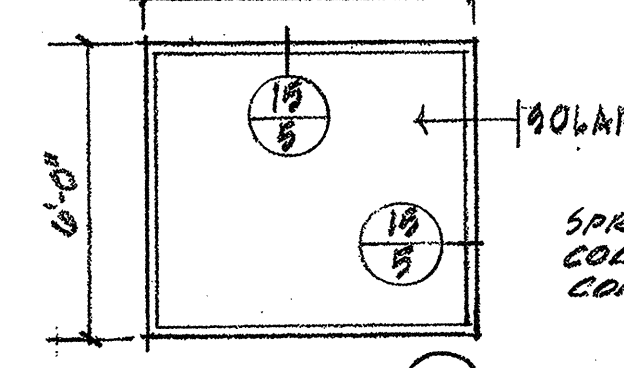
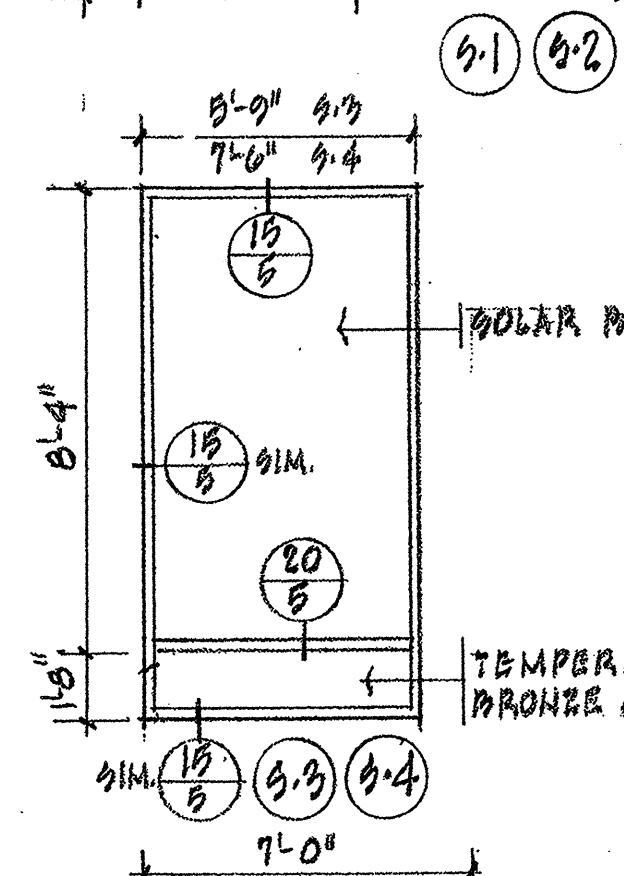
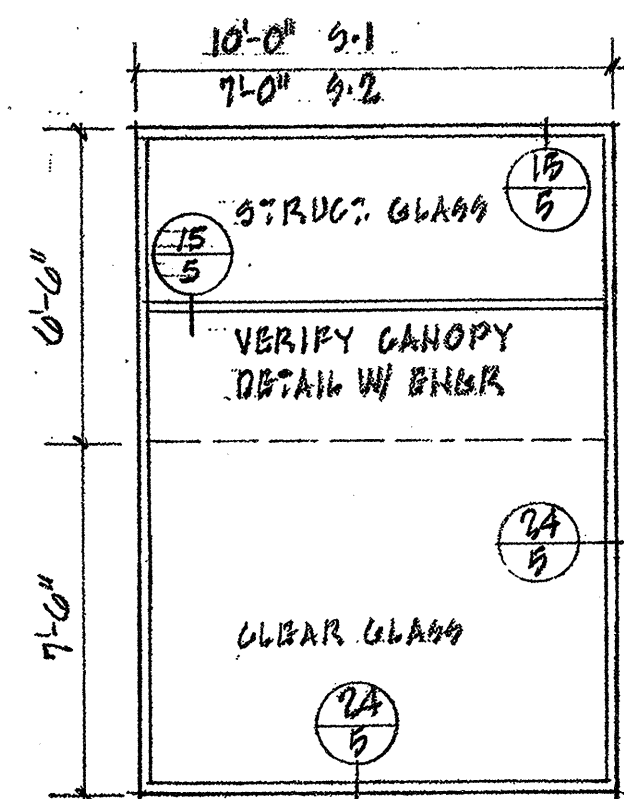

STOREFRONT SCHEDULE 1/4" = 1'-0"

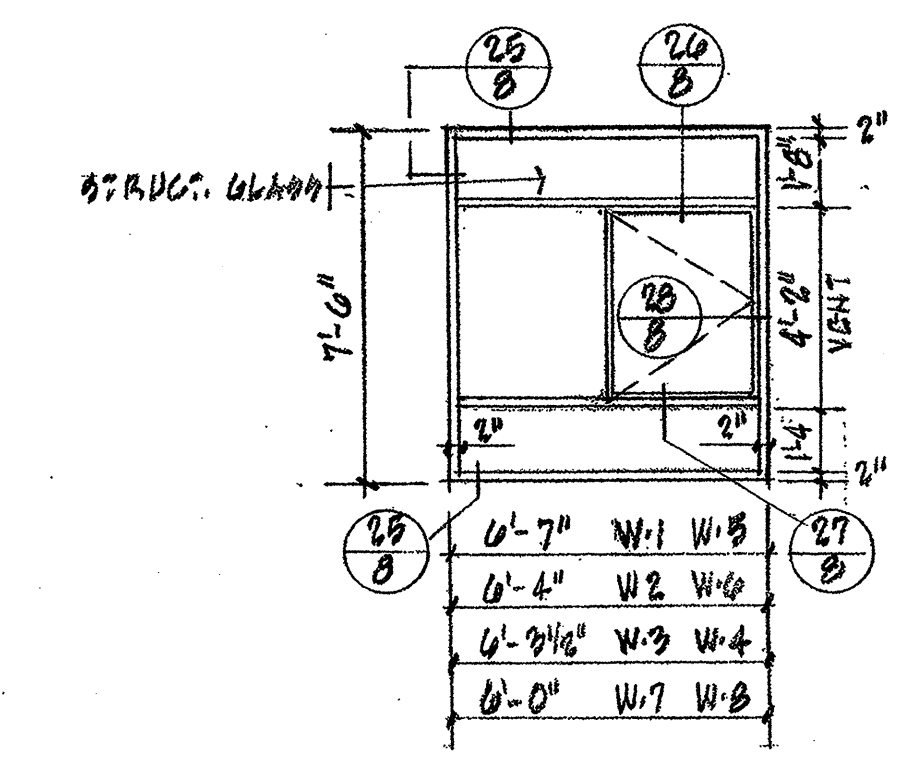
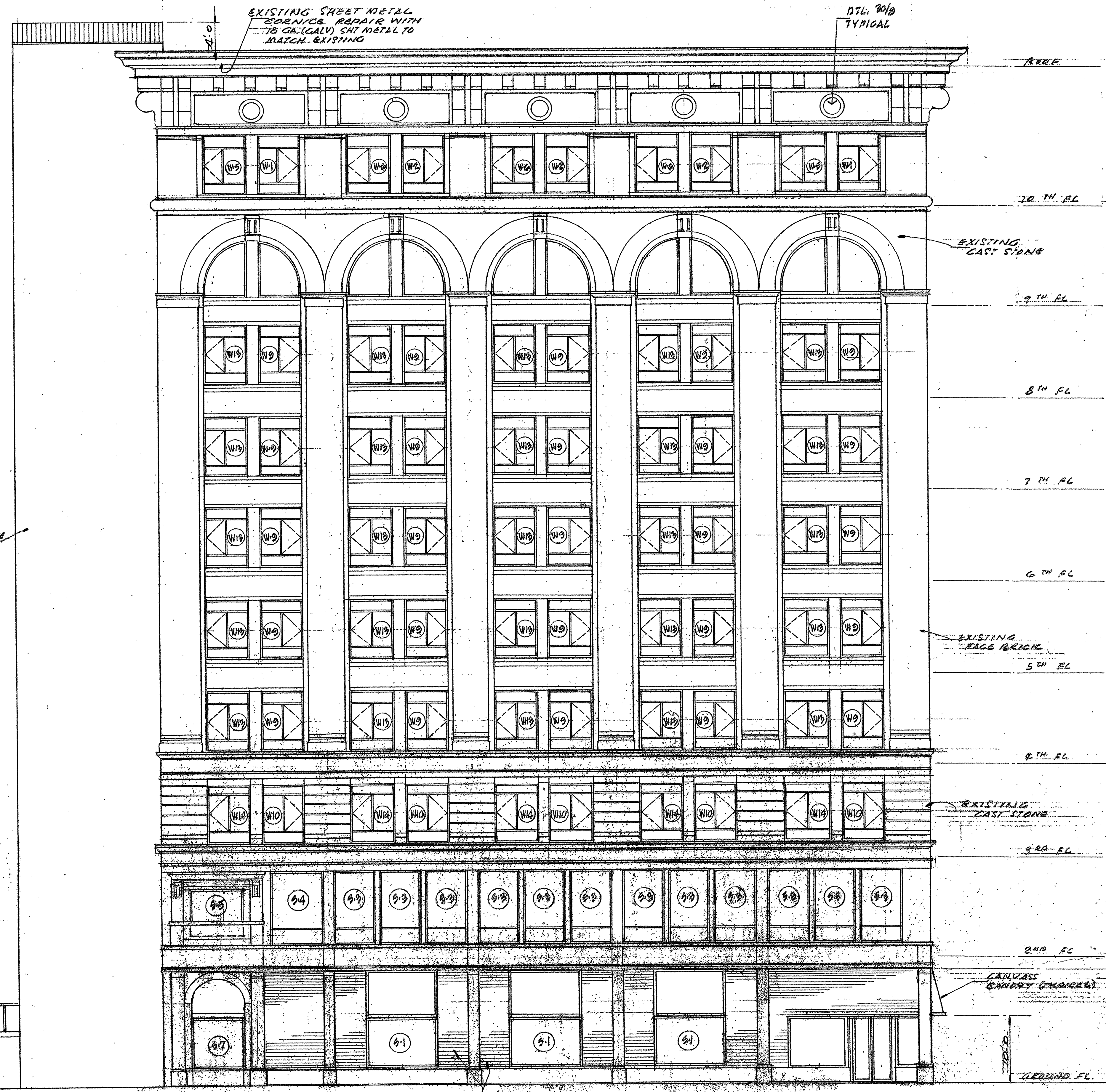

- | | |
|----------|--------------|
| AS SHOWN | VENT ON LEFT |
| W1 | W5 |
| W2 | W6 |
| W3 | W7 |
| W4 | W8 |

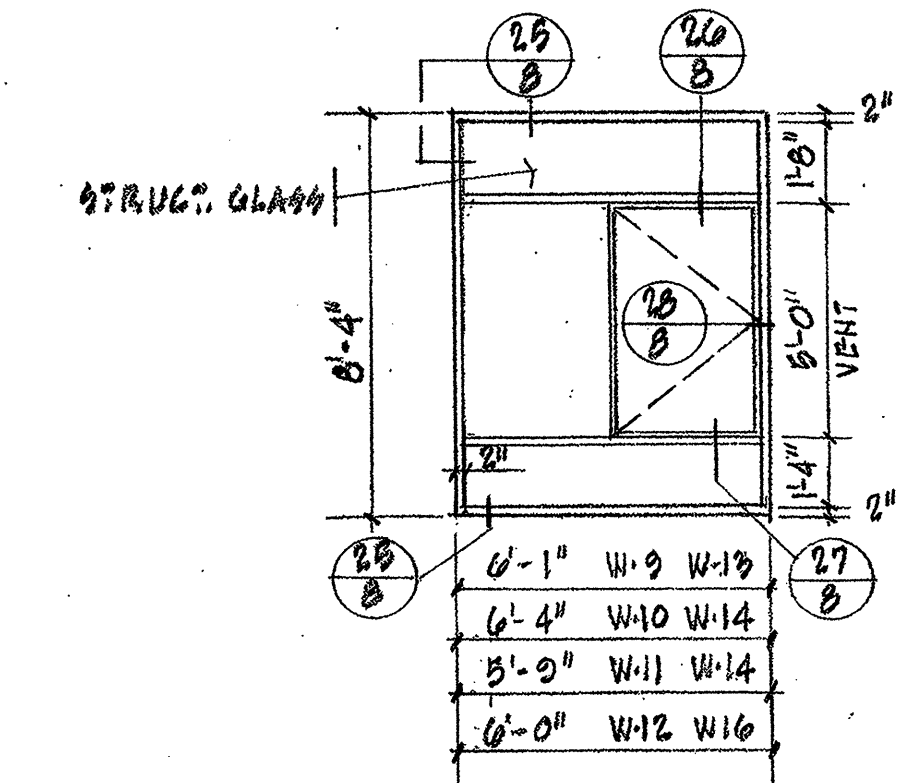

- | | |
|----------|--------------|
| AS SHOWN | VENT ON LEFT |
| W9 | W13 |
| W10 | W14 |
| W11 | W15 |
| W12 | W16 |

NOTE:
 ALL GLASS SHALL BE "SOLAR BRONZE" EXCEPT WHERE "STRUCT. GLASS" IS SHOWN "STRUCT. GLASS" SHALL BE ASQ "HUBTEX" LOP "VITROLUX HEAT STRENGTHENED GLASS W/ FUSED CERAMIC COLOR ON INDOOR FACE; BRONZE COLOR TO HARMONIZE WITH ADJ. AGENT "SOLAR BRONZE" GLASS

WINDOW SCHEDULE 1/4" = 1'-0"
 VERIFY ALL WINDOW DIMENSIONS IN FIELD

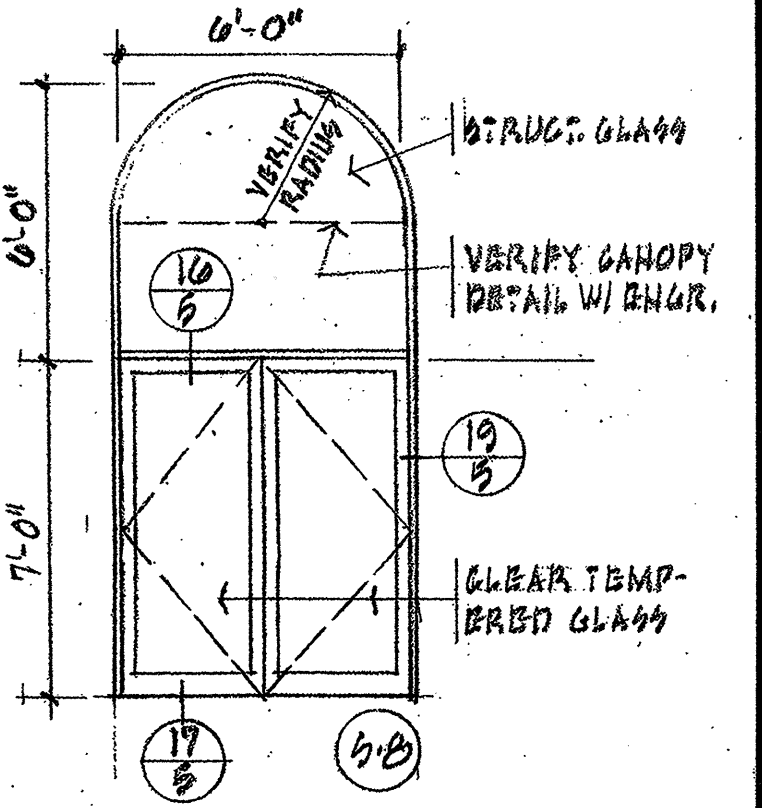
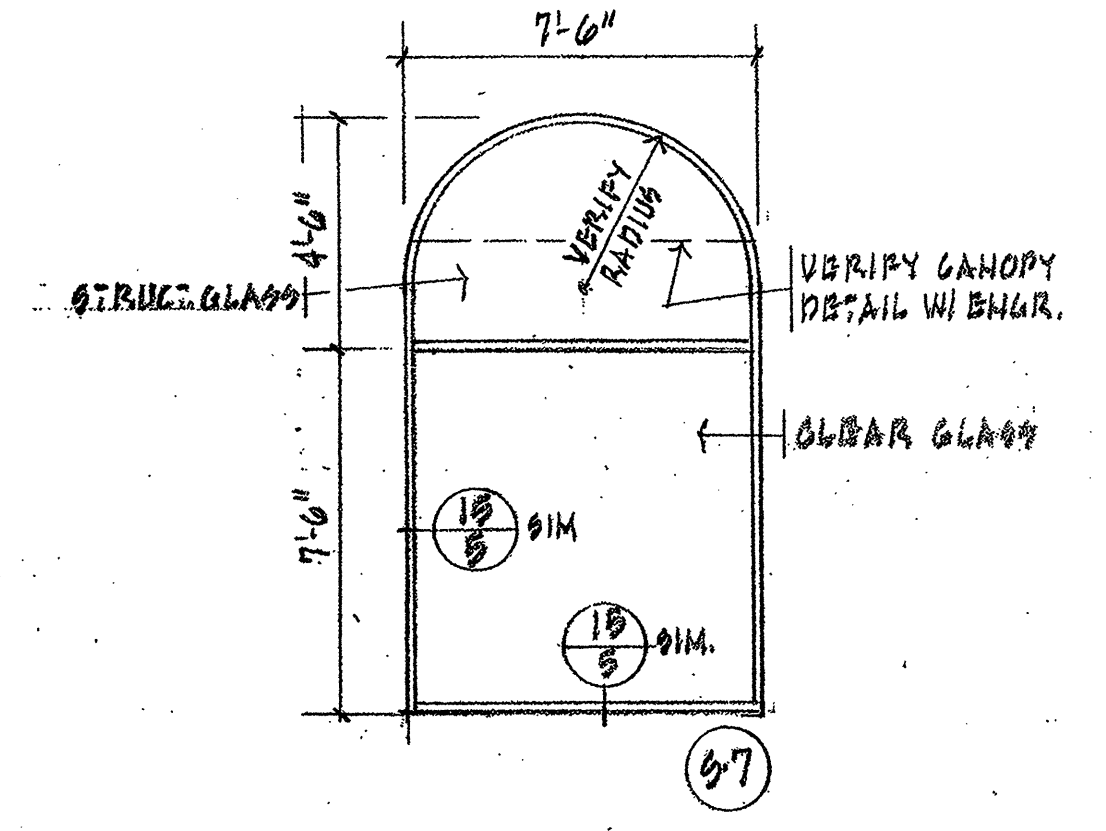

STOREFRONT SCHEDULE 1/4" = 1'-0"

VERIFY ALL STOREFRONT DIMENSIONS IN FIELD FOR GROUND FLOOR STOREFRONT ELEVATIONS AT WEST SIDE SEE SHT. 14 FOR "STRUCT. GLASS" SPEC. SEE WINDOW SCHEDULE ABOVE. SEE SHT. 14 FOR INTERIOR STOREFRONT WINDOW IN LOBBY AT GROUND FLOOR.

SOUTH ELEVATION (MISSION STREET)

NOTE: THE ENTIRE SOUTH ELEVATION OF THE EXISTING BUILDING (INCLUDING CORNICE) TO BE WASHED WITH DETERGENT & STAIN CLEARED.

MERCANTILE CENTER BUILDING ADDITIONS & REHABILITATION THIRD & MISSION STREET SAN FRANCISCO, CA	
DATE	2-26-79
DATE	5/31/78
T/W ASSOCIATES 390 FOURTH STREET, SAN FRANCISCO, CA	
OWNER	CHIL & STRUCTURAL ENGINEERS 380 FORTH ST. SAN FRANCISCO, CALIF. 94103

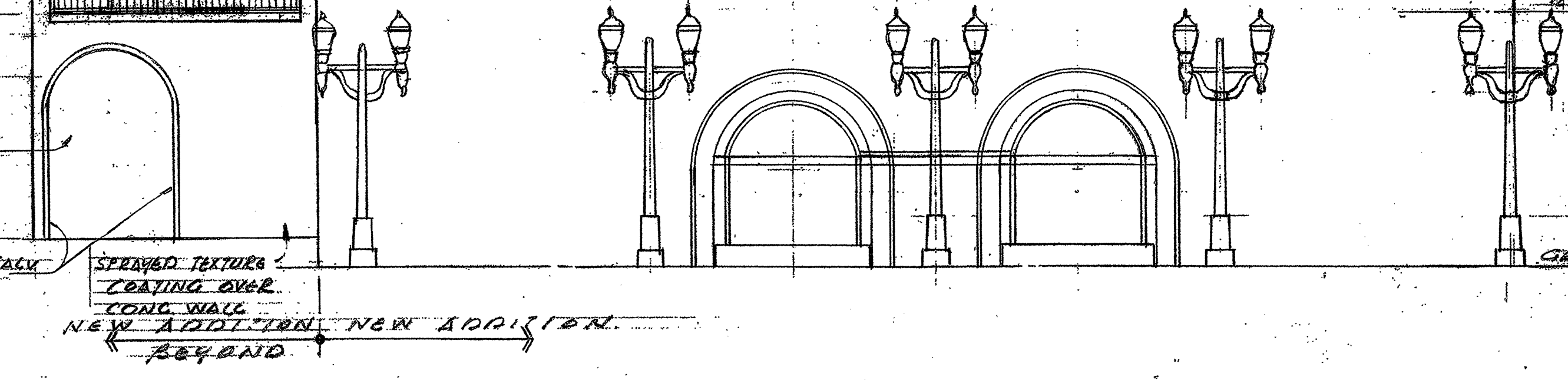
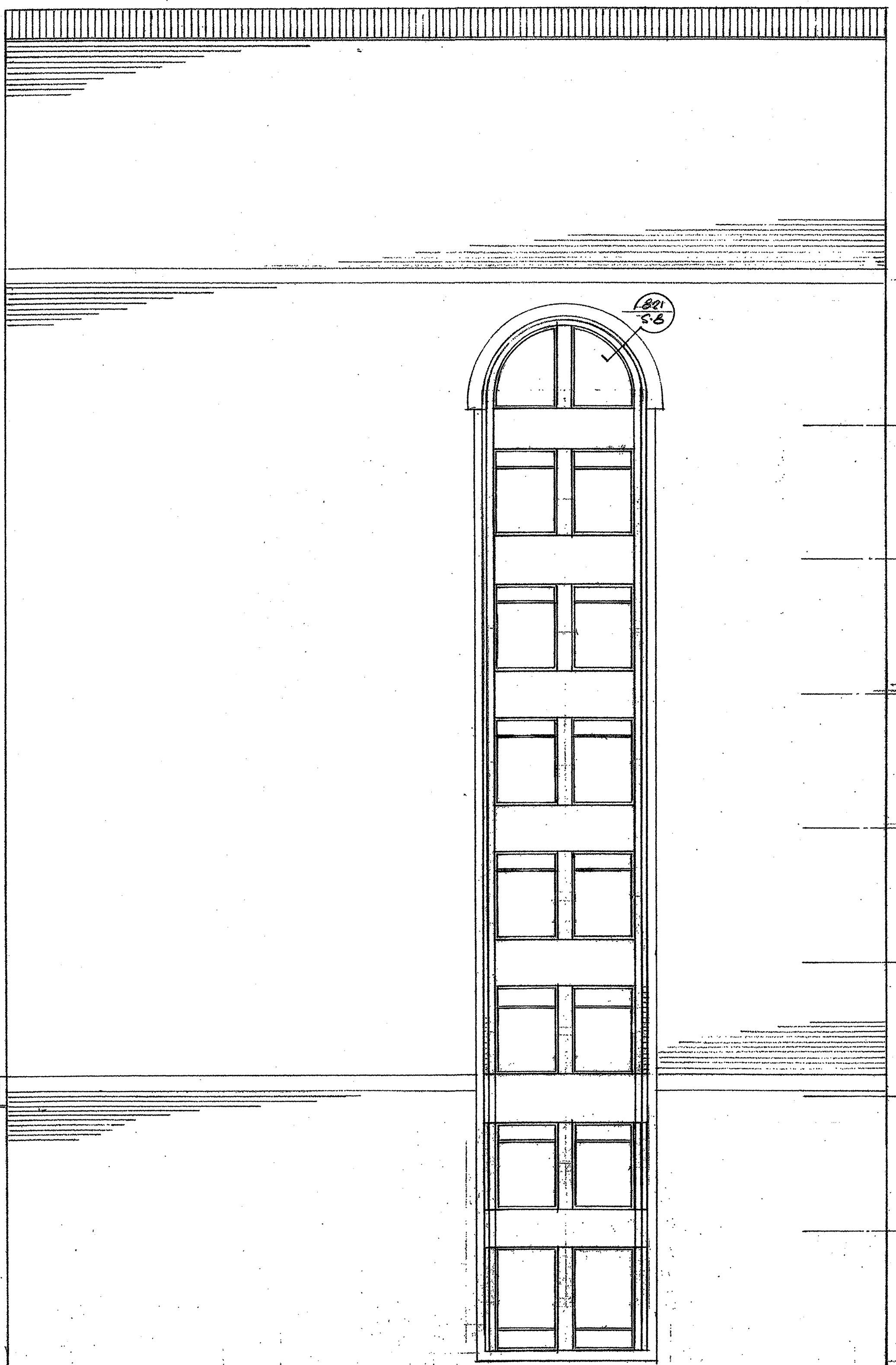
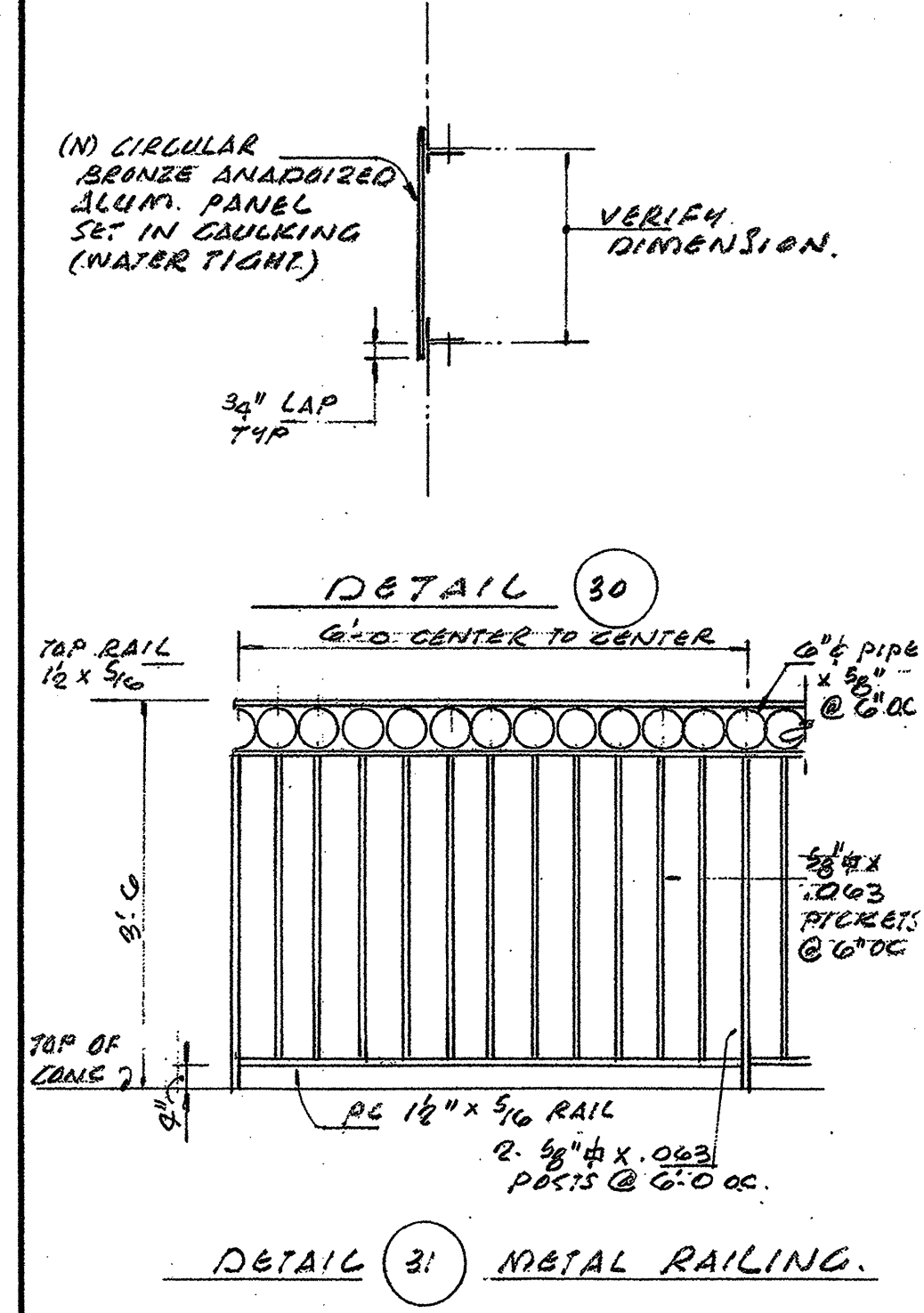

WEST ELEVATION

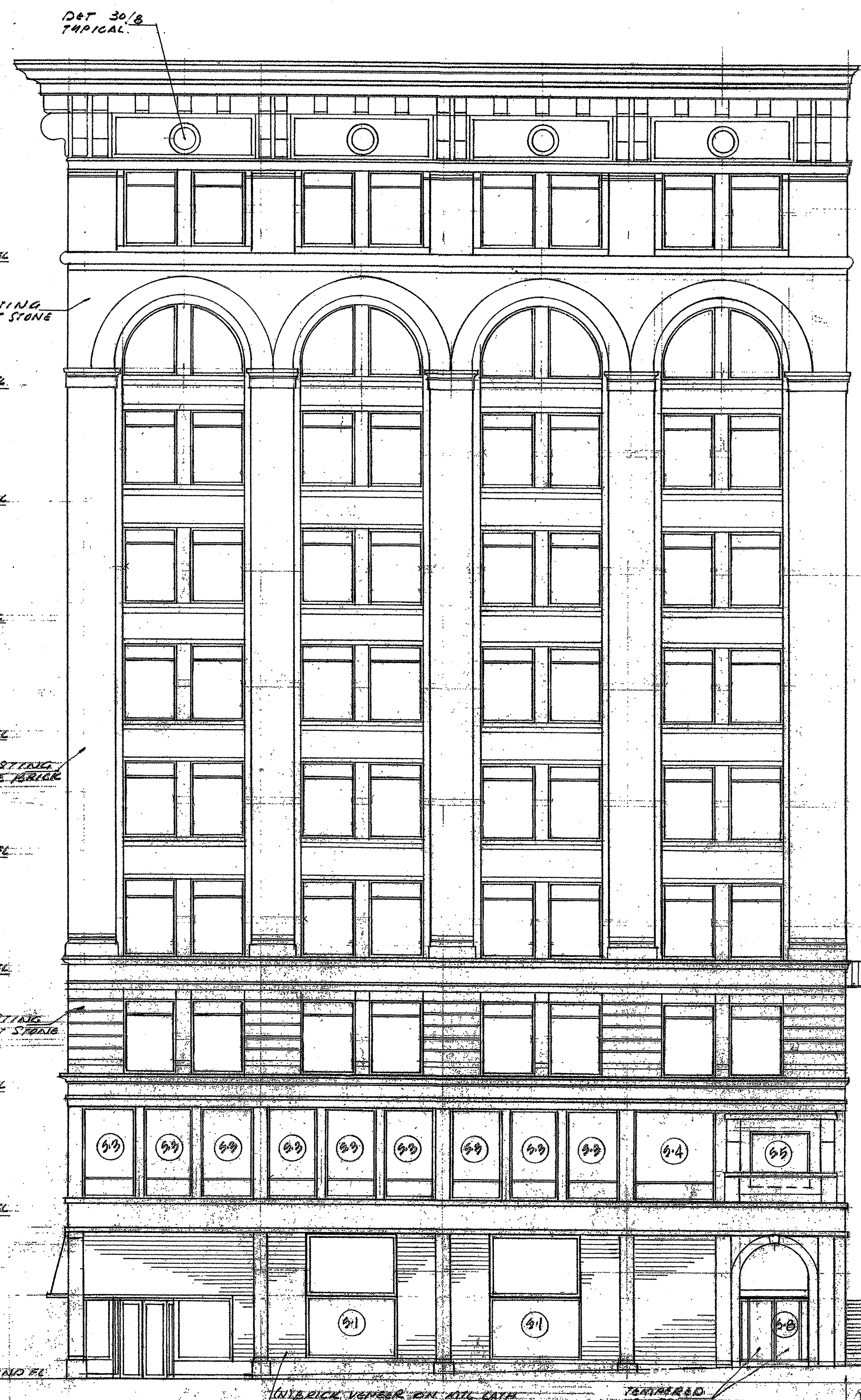

EAST ELEVATION (THIRD STREET)

NOTE: THE ENTIRE EAST ELEVATION OF THE EXISTING BUILDING (INCLUDING CORNICE) TO BE WASH WITH DETERGENT & STEAM CLEAN

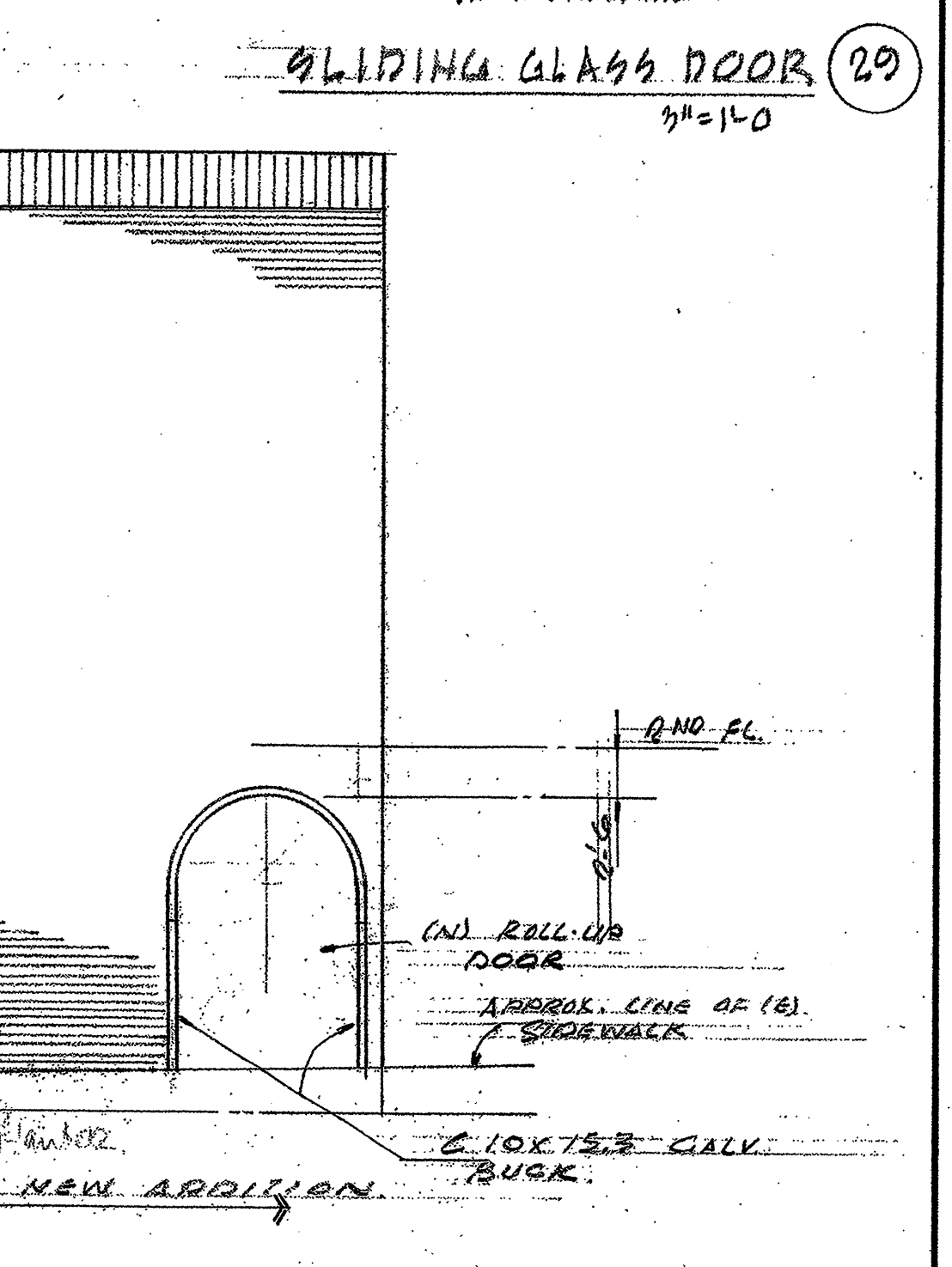
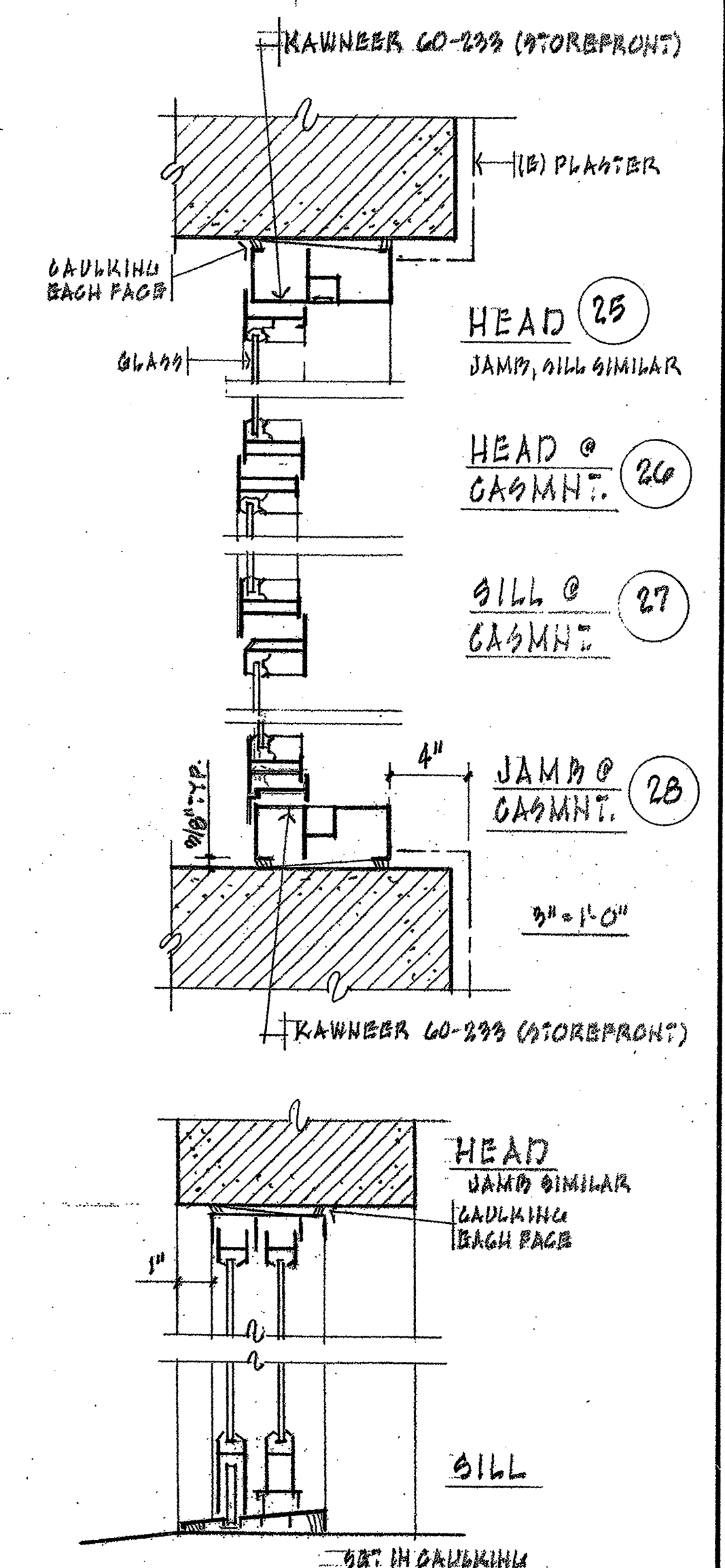

MERCANTILE CENTER BUILDING ADDITIONS & REHABILITATION THIRD & MISSION STREET SAN FRANCISCO, CA

2-26-79

5/31/78

TJM ASSOCIATES

330 CALIFORNIA STREET, SAN FRANCISCO, CA

CIVIL & STRUCTURAL ENGINEER

330 CALIFORNIA STREET, SAN FRANCISCO, CA 94104

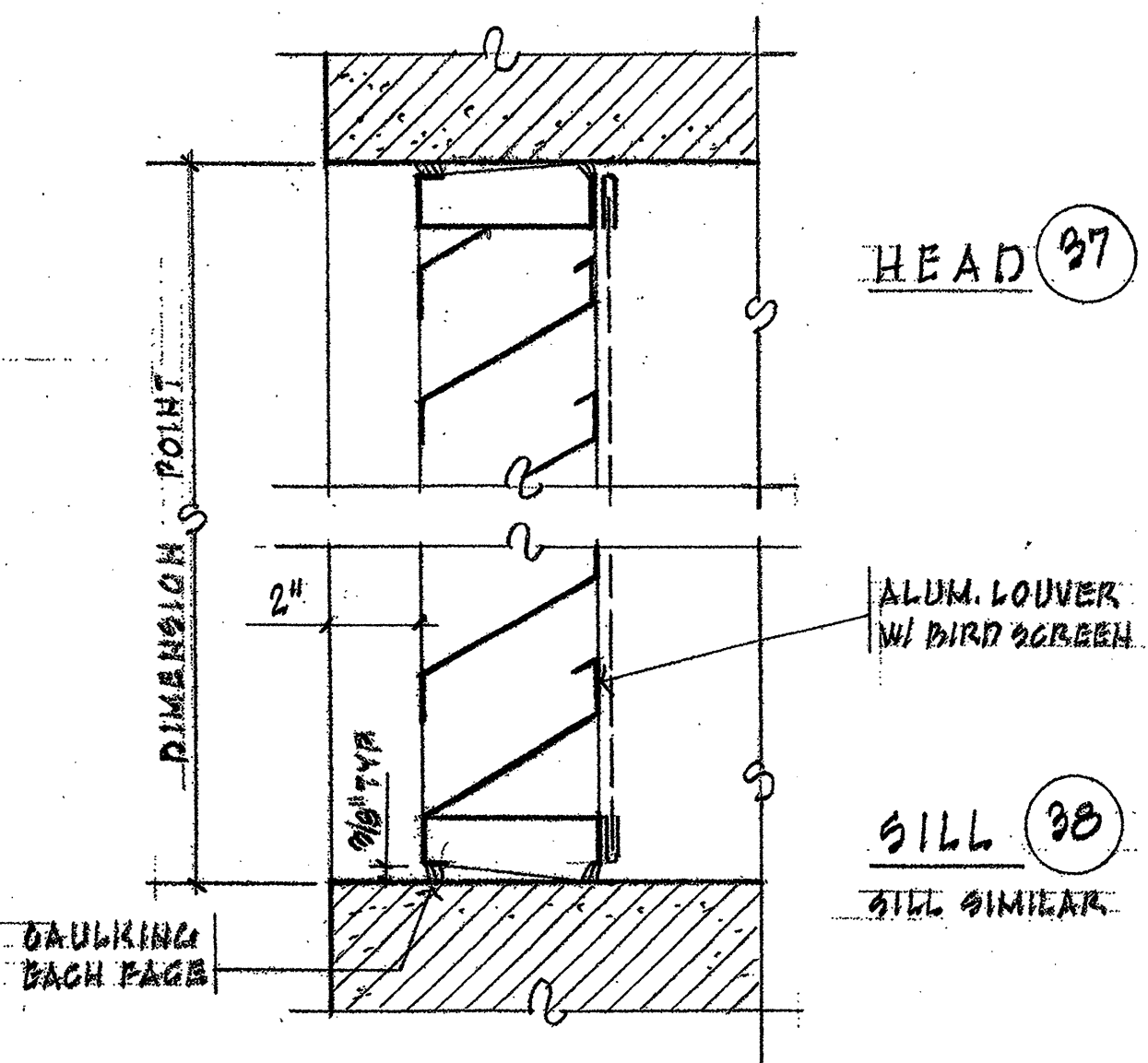
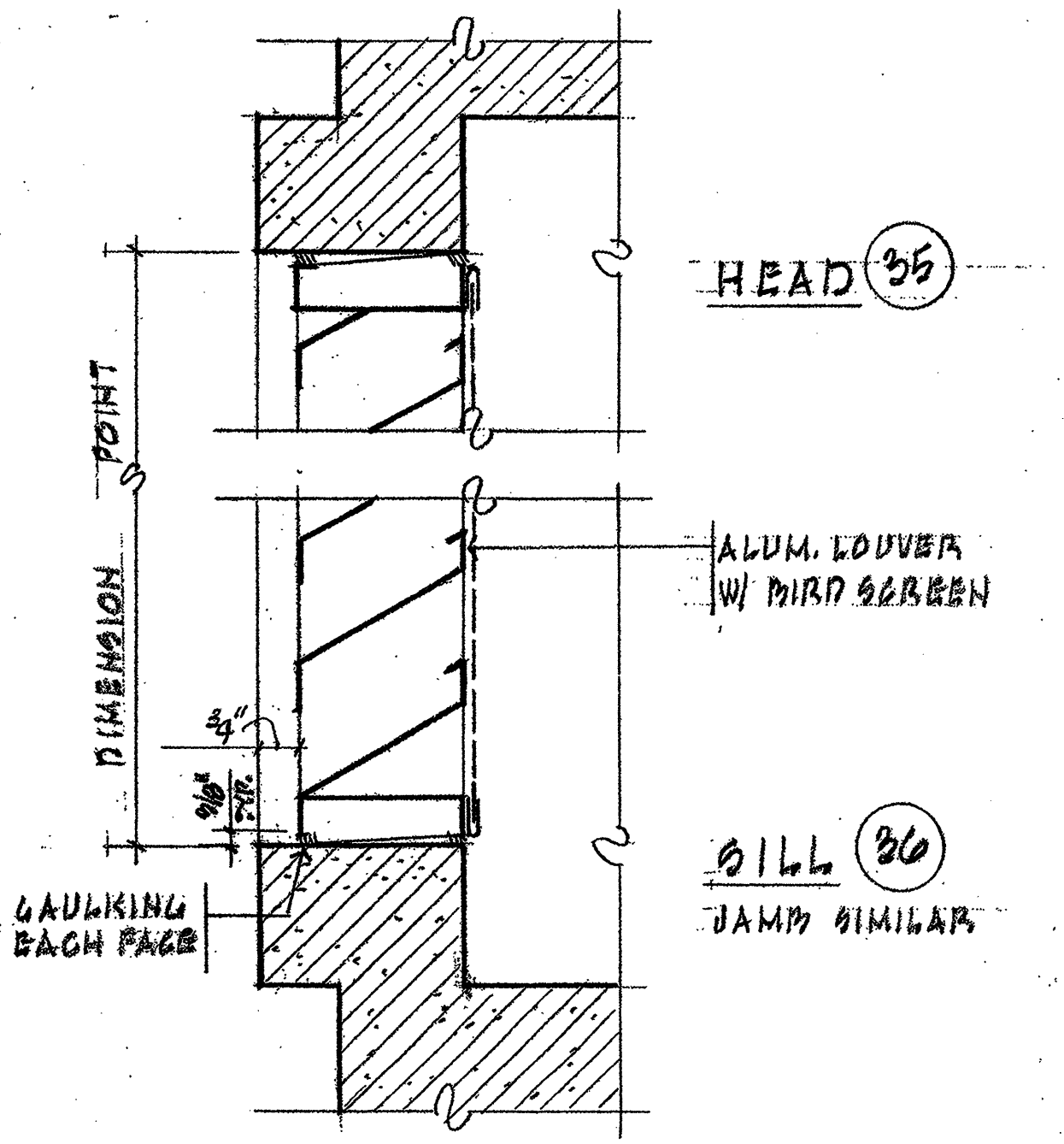
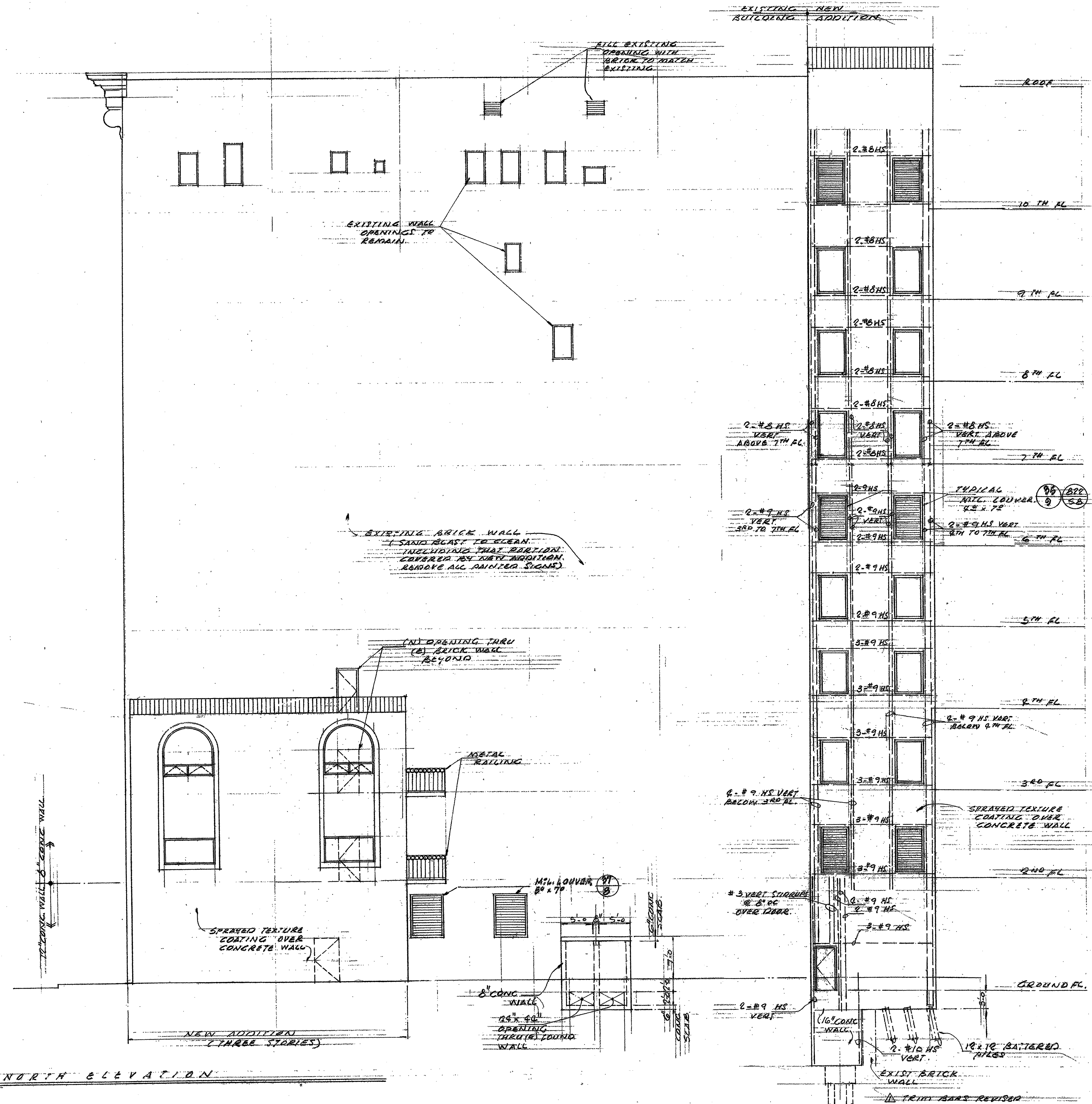

NORTH ELEVATION

TRIM BARS REVISOR		5-28-79
MERCANTILE CENTER BUILDING		
ADD'L 1, 2, 3 - REHABILITATION		
390 - 4 MISION STREET, SAN FRANCISCO, CA		
		5/31/79
T/W ASSOCIATES		
390 - FOURTH STREET, SAN FRANCISCO, CA		
WONG	CIVIL & STRUCTURAL ENGINEER	9
390 FOURTH ST. SAN FRANCISCO, CAL. 94102		

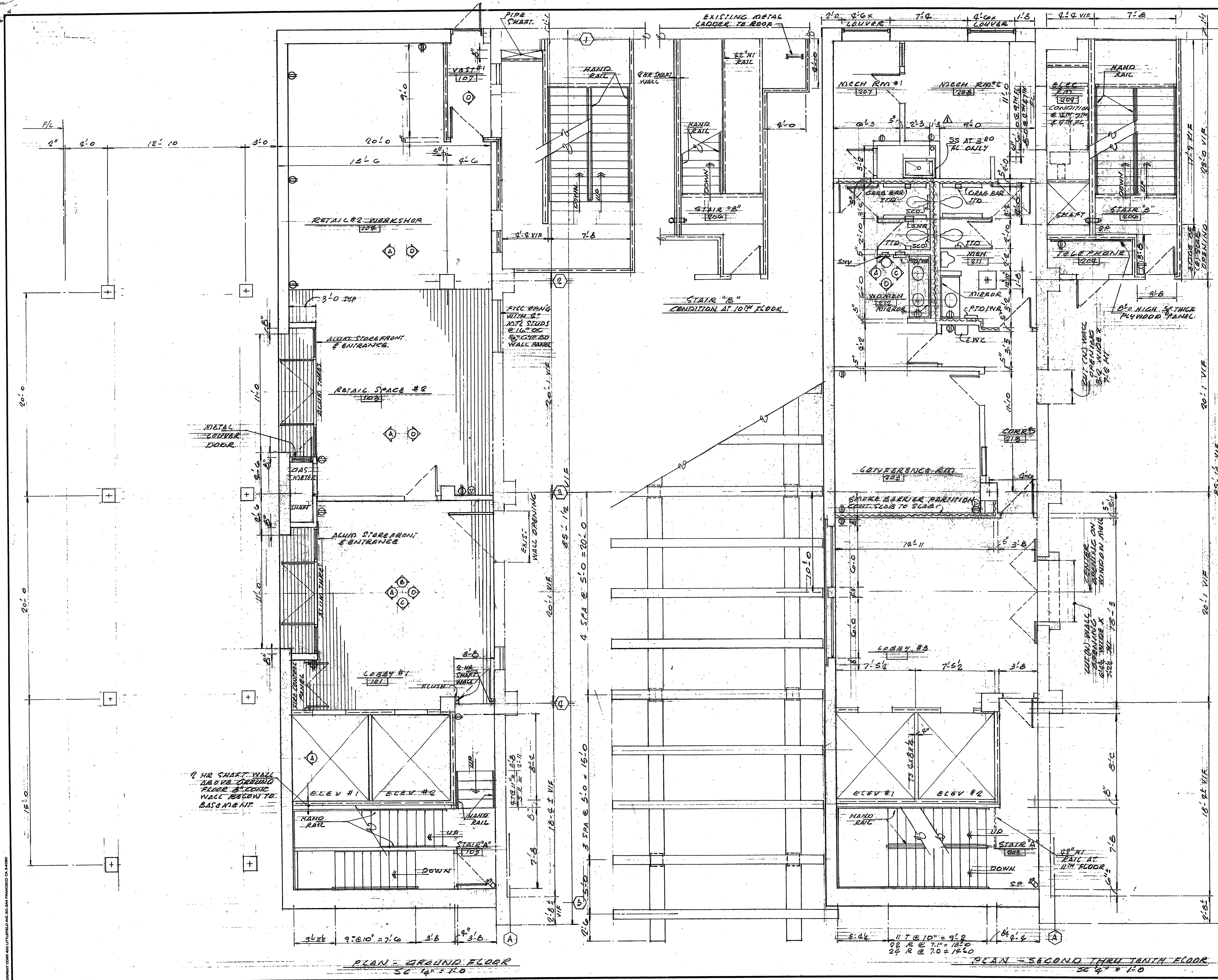

- LEGEND**
- NEW MASONRY WALL
 - EXISTING MASONRY WALL
 - NEW 3 1/2" METAL STUD PARTITION UNLESS OTHERWISE NOTED
 - NEW 2" METAL STUD PARTITION UNLESS OTHERWISE NOTED
 - SHAFT WALL, CONTINUOUS SLAB TO SLAB
 - NEW CONCRETE WALL
 - NEW SOUND INSULATED PARTITIONS
 - INTERIOR ELEVATION KEY SEE SHEET 18 & 15

NOTE:
 ALL 3 1/2" METAL STUD PARTITIONS AND FINISH CONTINUOUS SLAB TO SLAB EXCEPT WHERE SUSPENDED GYPSUM BOARD CEILING OCCUR ON BOTH SIDES AT THIS CONDITION METAL STUDS AND FINISH STOPS AT CEILING.

- TOILET ROOM ACCESSORIES**
- RTO/WR - COMBINATION PAPER TOWEL DISPENSER & WASTE RECEPTACLE
 - TID - TOILET TISSUE DISPENSER
 - SCO - SEAT COVER DISPENSER
 - SNV - SANITARY NAPKIN VENDOR
 - SND - SANITARY NAPKIN DISPOSAL
 - AT - ASH TRAY

MERCANTILE CENTER BUILDING
 300 CALIFORNIA STREET, SAN FRANCISCO, CALIF.
 THIRD FLOOR, 31400, SAN FRANCISCO, CALIF.

T/W ASSOCIATES
 390 FOURTH STREET, SAN FRANCISCO, CALIF.

2-26-79

DATAPRINT STOCKDRAFTING FORM NO. 101-84

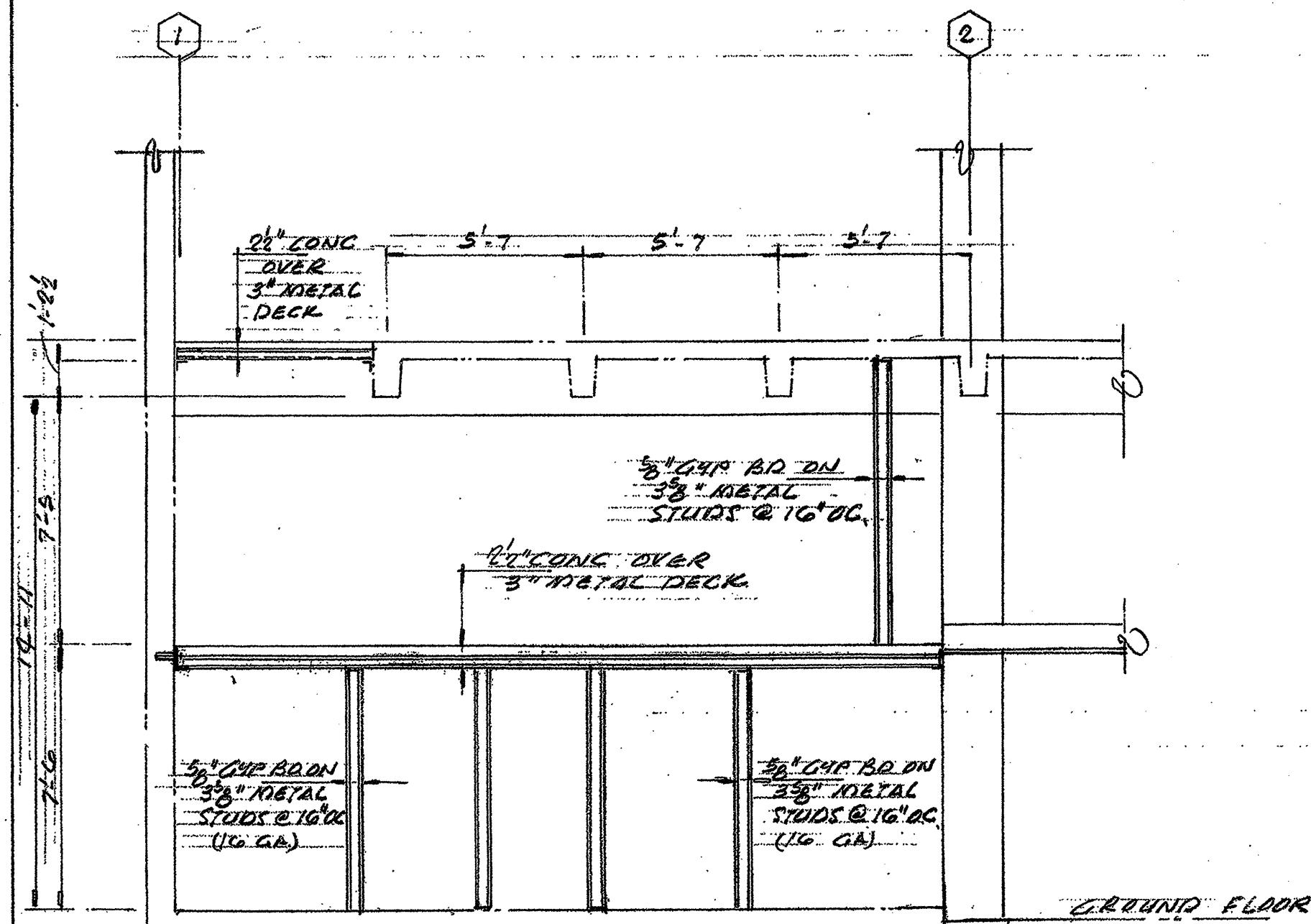

SECTION 1101
50'-4" x 1'-0"

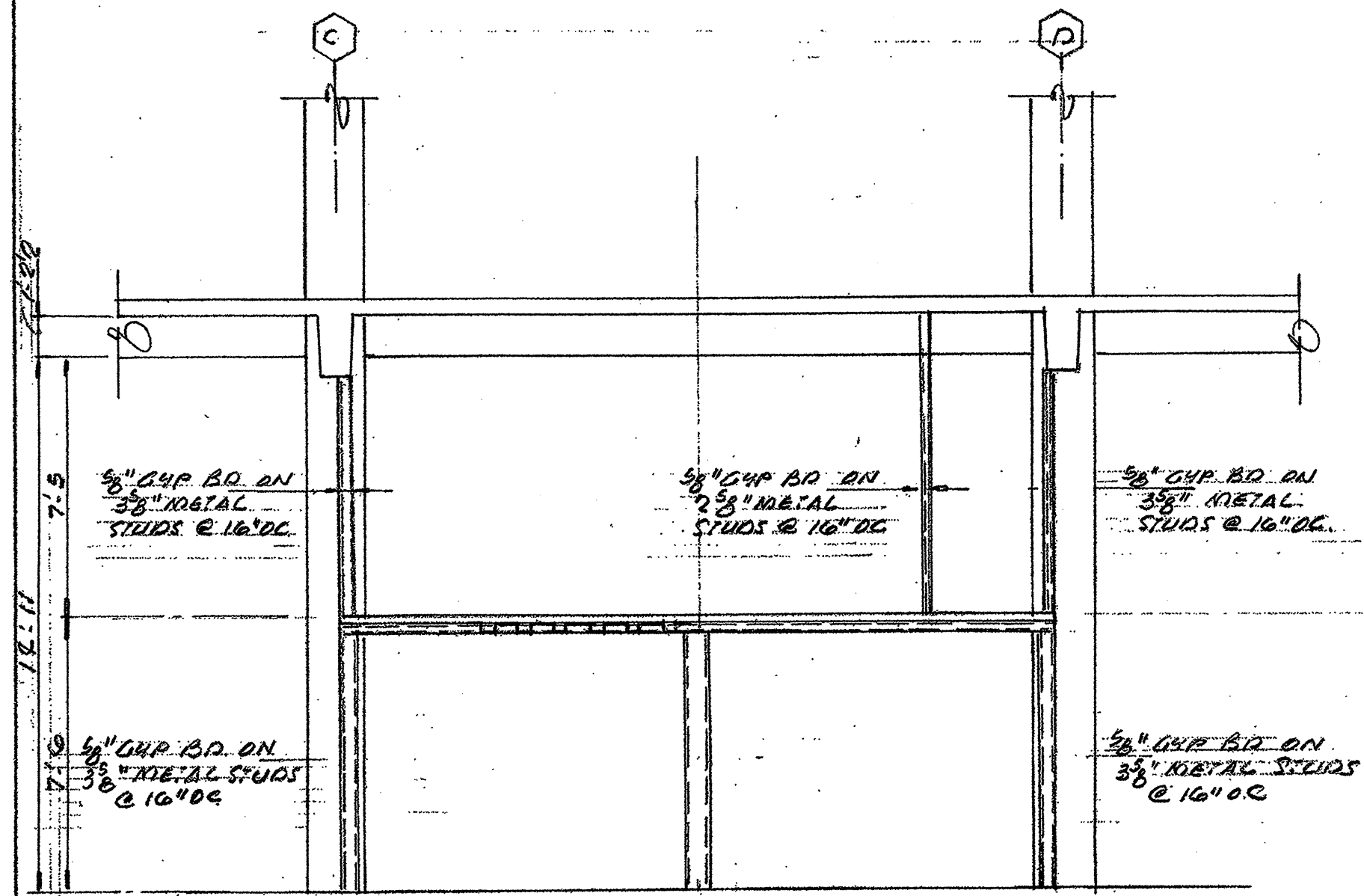

SECTION 1102
50'-4" x 1'-0"

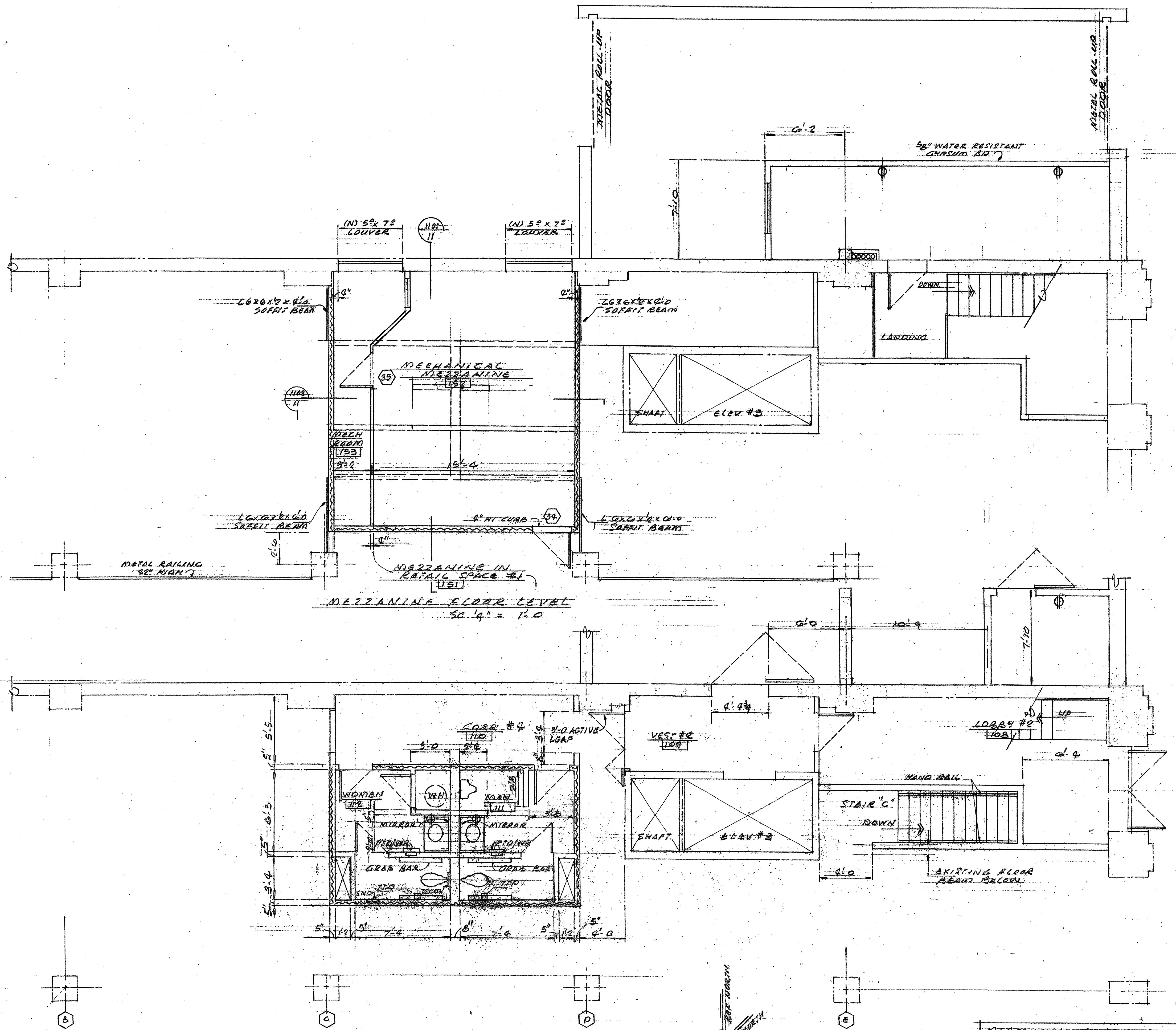

GROUND FLOOR LEVEL
50'-4" x 1'-0"

NOTE
FOR WALL AND PARTITION LEGEND
SEE SHEET 10

MERCANTILE CENTER BUILDING
RENOVATION & REHABILITATION
THIRD & MISSION STREET SAN FRANCISCO, CALIF.

T.W. ASSOCIATES
390 FOURTH STREET, SAN FRANCISCO, CALIF.

DATE: 0-16-79

WONG CIVIL & STRUCTURAL ENGINEER
180 TOWNE SQUARE, SAN FRANCISCO, CALIF. 94102

ARCHITECTURE
PLANNING & RESEARCH
MATERIALS CONSERVATION

www.page-turnbull.com

1000 Sansome Street, Suite 200
San Francisco, California 94108
415.362.5154 / 415.362.5560 fax

2401 C Street, Suite B
Sacramento, California 95816
916.930.9903 / 916.930.9904 fax

417 S. Hill Street, Suite 211
Los Angeles, California 90013
213.221.1200 / 213.221.1209 fax