



SAN FRANCISCO PLANNING DEPARTMENT

Executive Summary Conditional Use

HEARING DATE: NOVEMBER 29, 2012

Date: November 20, 2012
Case No.: **2012.1142 C**
Project Address: **2815 DIAMOND STREET**
Zoning: Glen Park Neighborhood Commercial Transit District
40-X Height and Bulk District
Block/Lot: 6745/074
Project Sponsor: Nathan Jose
Security Vault Works
25079 Viking Street
Hayward, CA 94545
Staff Contact: Rick Crawford – (415) 558-6358
rick.crawford@sfgov.org
Recommendation: **Approval with Conditions**

1650 Mission St.
Suite 400
San Francisco,
CA 94103-2479

Reception:
415.558.6378

Fax:
415.558.6409

Planning
Information:
415.558.6377

PROJECT DESCRIPTION

The project is for a new ATM for Wells Fargo Bank to replace the existing Wells Fargo ATM in front of Canyon Market. The new ATM would be setback between 17 inches and 21 inches from the property line.

SITE DESCRIPTION AND PRESENT USE

The project is located on the easterly side of Diamond Street, on the southeast corner of the intersection with Wilder Street, Block 6745, Lot 074. The property is located within the Glen Park Neighborhood Commercial Transit District with 40-X Height and Bulk district. The property is developed with a two- to four-story mixed use building with 15 dwelling units on Wilder Street, a grocery store (D.B.A. Canyon Market) and the Glen Park Branch of the San Francisco Public Library both fronting on Diamond Street. A Wells Fargo ATM is located on the property in front of the Canyon Market and would be replaced by the project. The existing ATM is setback between 27 inches and 31 inches from the front property line. The building permit for this ATM was approved in error in 2008 without the Conditional Use authorization that is required for an ATM setback less than three feet from the property line.

SURROUNDING PROPERTIES AND NEIGHBORHOOD

The project site is located within the Glen Park commercial district along Diamond Street. The area features two- to four-story mixed-use buildings with ground-floor commercial uses and residential uses on the upper floors. The Glen Park BART Station is located one block to the south. The surrounding properties are located within the RH-1 (Residential House, One-Family) and RH-2 (Residential House, Two-Family) Districts and occupied by two-to three-story residential buildings.

ENVIRONMENTAL REVIEW

The Project is exempt from the California Environmental Quality Act ("CEQA") as a Class 1 categorical exemption.

HEARING NOTIFICATION

TYPE	REQUIRED PERIOD	REQUIRED NOTICE DATE	ACTUAL NOTICE DATE	ACTUAL PERIOD
Classified News Ad	20 days	November 9, 2012	November 7, 2012	22 days
Posted Notice	20 days	November 9, 2012	November 5, 2012	24 days
Mailed Notice	10 days	November 19, 2012	November 6, 2012	23 days

The proposal requires a Section 312-neighborhood notification, which was conducted in conjunction with the conditional use authorization process.

PUBLIC COMMENT

- To date, the Department has not received any public comment on the project.

ISSUES AND OTHER CONSIDERATIONS

- ATMs that are recessed 3 feet are principally permitted and do not require Conditional Use authorization. The intent of the requirement for conditional use approval for ATMs that are not recessed is to maintain unobstructed pedestrian circulation in the district. The sidewalk in front of the Project Site is approximately nine feet wide and the ATM would be setback between 17 and 21 inches from the property line. The width of the walk, combined with the proposed setback, would be adequate to allow customers to queue when waiting to use the ATMs while still allowing ample room for pedestrian circulation.
- The ATM would be one of three ATMs on the block associated with a financial institution. A CITI Bank ATM is located one block south and a Bank of America ATM is located across Diamond Street. Private ATMs are located within businesses within the district and are commercial franchise machines that tend to charge higher user fees.
- The project would replace an existing ATM that was approved in error in 2008. The existing facility is setback 27 inches to 31 inches from the property line.
- Planning Code Section 709.110 defines Formula Retail to include Financial Services as a retail use that provides banking services and products to the public, such as banks, savings and loans, and credit unions, when occupying more than 15 feet of linear frontage or 200 square feet of gross floor area. The proposed ATM occupying less than 15 feet of linear frontage and would be less than 200 square feet in area. The proposed ATM is not Formula Retail under the Planning Code.

REQUIRED COMMISSION ACTION

In order for the project to proceed, the Commission must grant conditional use authorization to allow a Walk-Up Facility located at 2815 Diamond Street, Block 6745, and Lot 074, pursuant to Planning Code Section 738.26 within the Glen Park Neighborhood Commercial Transit District and a 40-X Height and Bulk District

BASIS FOR RECOMMENDATION

- The project replaces an existing ATM in a similar location that was approved in error in 2008.
- The ATM would be one of three ATMs in the District associated with a financial institution. Other ATMs in the District are private commercial franchise machines, inside businesses, that tend to charge higher user fees.
- The project meets all applicable requirements of the Planning Code.
- The project is desirable for, and compatible with the surrounding neighborhood.
- The business is not a Formula Retail use and would serve the immediate neighborhood.

RECOMMENDATION: Approval with Conditions
--

Attachments:

Block Book Map
Sanborn Map
Zoning Map
Aerial Photograph
Site Photographs
Context Photograph
Reduced Plans

Attachment Checklist

- | | |
|---|--|
| <input checked="" type="checkbox"/> Executive Summary | <input checked="" type="checkbox"/> Project sponsor submittal |
| <input checked="" type="checkbox"/> Draft Motion | Drawings: <u>Existing Conditions</u> |
| <input type="checkbox"/> Environmental Determination | <input checked="" type="checkbox"/> Check for legibility |
| <input checked="" type="checkbox"/> Zoning District Map | Drawings: <u>Proposed Project</u> |
| <input checked="" type="checkbox"/> Height & Bulk Map | <input checked="" type="checkbox"/> Check for legibility |
| <input checked="" type="checkbox"/> Parcel Map | <input type="checkbox"/> Wireless Telecommunications Materials |
| <input checked="" type="checkbox"/> Sanborn Map | <input type="checkbox"/> Health Dept. review of RF levels |
| <input checked="" type="checkbox"/> Aerial Photo | <input type="checkbox"/> RF Report |
| <input checked="" type="checkbox"/> Context Photos | <input type="checkbox"/> Community Meeting Notice |
| <input checked="" type="checkbox"/> Site Photo | <input type="checkbox"/> Housing Documents |
| | <input type="checkbox"/> Inclusionary Affordable Housing Program: Affidavit for Compliance |
| | <input type="checkbox"/> Residential Pipeline |

Exhibits above marked with an "X" are included in this packet

_____ RC _____
Planner's Initials



SAN FRANCISCO PLANNING DEPARTMENT

Subject to: (Select only if applicable)

- | | |
|--|--|
| <input type="checkbox"/> Affordable Housing (Sec. 415) | <input type="checkbox"/> First Source Hiring (Admin. Code) |
| <input type="checkbox"/> Jobs Housing Linkage Program (Sec. 413) | <input type="checkbox"/> Child Care Requirement (Sec. 414) |
| <input type="checkbox"/> Downtown Park Fee (Sec. 412) | <input type="checkbox"/> Other |

1650 Mission St.
Suite 400
San Francisco,
CA 94103-2479

Reception:
415.558.6378

Fax:
415.558.6409

Planning
Information:
415.558.6377

Planning Commission Draft Motion

HEARING DATE: NOVEMBER 29, 2012

Date: November 20, 2012
Case No.: **2012.1142 C**
Project Address: **2815 DIAMOND STREET**
Zoning: Glen Park Neighborhood Commercial Transit District
40-X Height and Bulk District
Block/Lot: 6745/074
Project Sponsor: Nathan Jose
Security Vault Works
25079 Viking Street
Hayward, CA 94545
Staff Contact: Rick Crawford – (415) 558-6358
rick.crawford@sfgov.org

ADOPTING FINDINGS RELATING TO THE APPROVAL OF CONDITIONAL USE AUTHORIZATION PURSUANT TO SECTIONS 303 AND 738.26 OF THE PLANNING CODE TO ALLOW A WALK-UP FACILITY, AN ATM FOR WELLS FARGO BANK, WITHIN THE GLEN PARK NEIGHBORHOOD COMMERCIAL TRANSIT DISTRICT AND A 40-X HEIGHT AND BULK DISTRICT.

PREAMBLE

On August 31, 2012, Nathan Jose (hereinafter “Project Sponsor”) filed an application with the Planning Department (hereinafter “Department”) for Conditional Use Authorization under Planning Code Sections 303 and 738.26, Walk-Up Facility, to allow a new ATM for Wells Fargo Bank to replace the existing ATM within the Glen Park Neighborhood Commercial Transit District and a 40-X Height and Bulk District.

On November 29, 2012, the San Francisco Planning Commission (hereinafter “Commission”) conducted a duly noticed public hearing at a regularly scheduled meeting on Conditional Use Application No. 2012.1142C.

The project is categorically exempt as a Class 1 exemption under CEQA Guidelines.

The Commission has heard and considered the testimony presented to it at the public hearing and has further considered written materials and oral testimony presented on behalf of the applicant, Department staff, and other interested parties.

MOVED, that the Commission hereby authorizes the Conditional Use requested in Application No. 2012.1142C, subject to the conditions contained in "EXHIBIT A" of this motion, based on the following findings:

FINDINGS

Having reviewed the materials identified in the preamble above, and having heard all testimony and arguments, this Commission finds, concludes, and determines as follows:

1. The above recitals are accurate and constitute findings of this Commission.
2. **Site Description and Present Use.** The project is located on the easterly side of Diamond Street, on the southeast corner of the intersection with Wilder Street, Block 6745, Lot 074. The property is located within the Glen Park Neighborhood Commercial Transit District with 40-X Height and Bulk district. The property is developed with a two- to four-story mixed use building with 15 dwelling units on Wilder Street, a grocery store (D.B.A. Canyon Market) and the Glen Park Branch of the San Francisco Public Library both fronting on Diamond Street. A Wells Fargo ATM is located on the property in front of the Canyon Market and would be replaced by the project. The existing ATM is setback between 27 inches and 31 inches from the front property line. The building permit for this ATM was approved in error in 2008 without the Conditional Use authorization that is required for an ATM setback less than three feet from the property line.
3. **Surrounding Properties and Neighborhood.** The project site is located within the Glen Park commercial district along Diamond Street. The area features two- to four-story mixed-use buildings with ground-floor commercial uses and residential uses on the upper floors. The Glen Park BART Station is located one block to the south. The surrounding properties are located within the RH-1 (Residential House, One-Family) and RH-2 (Residential House, Two-Family) Districts and occupied by two-to three-story residential buildings.
4. **Project Description.** The project is for a new ATM for Wells Fargo Bank to replace the existing Wells Fargo ATM in front of Canyon Market. The new ATM would be setback between 17 inches and 21 inches from the property line.
5. **Public Comment.** To date, the Department has not received any public comment on the project.
6. **Planning Code Compliance:** The Commission finds that the Project is consistent with the relevant provisions of the Planning Code in the following manner:
 4. **Walk-Up Facility.** Planning Code Section 738.26 states that a Conditional Use Authorization is required for a Walk-Up Facility that is not setback three feet from the property line.

The project would replace the existing Wells Fargo ATM, approved in error in 2008 and setback 27 inches to 31 inches from the property line, with a new Wells Fargo ATM setback between 17 inches and 21 inches from the property line. The project would upgrade the ATM and the housing for the machine. The ATM would be one of three ATMs on the block associated with a financial institution. A CITI Bank ATM is located one block south and a Bank of America ATM is located across Diamond Street. Private ATMs are located within businesses within the district and are commercial franchise machines that tend to charge higher user fees.

5. **Formula Retail.** Planning Code Section 303(i)(2) defines Formula Retail to include Financial Services, defined in Planning Code Section 709.110 as a retail use that provides banking services and products to the public, such as banks, savings and loans, and credit unions, when occupying more than 15 feet of linear frontage or 200 square feet of gross floor area.

The proposed use is a Walk-Up Facility that would occupy less than 15 feet of linear frontage and would be less than 200 square feet in area. The proposed use is not Formula Retail under the Planning Code.

6. **Signage.** Any proposed signage will be subject to the review and approval of the Planning Department. Wells Fargo has undertaken a new branding program to change the signage at all their facilities. The program has been approved in concept by the Department and all signs are reviewed for consistency with the program. The proposed signage is consistent with the approved Wells Fargo branding program.
7. **Planning Code Section 303** establishes criteria for the Planning Commission to consider when reviewing applications for Conditional Use approval. On balance, the project does comply with said criteria in that:

- A. The proposed new uses and building, at the size and intensity contemplated and at the proposed location, will provide a development that is necessary or desirable, and compatible with, the neighborhood or the community.

The size of the proposed use is in keeping with other uses on the block face. The project ATM would be one of three ATMs located outside of another business. The other ATMs in the area are of the commercial variety that generally charges higher fees for use. Additional financial services and ATMs located outside of a business are desired in the District.

- B. The proposed project will not be detrimental to the health, safety, convenience, or general welfare of persons residing or working in the vicinity. There are no features of the project that could be detrimental to the health, safety or convenience of those residing or working the area, in that:
 - i. Nature of proposed site, including its size and shape, and the proposed size, shape and arrangement of structures;

The project is a tenant improvement in front of an existing building and replaces an existing ATM in the same location. The project would not change the size, shape, or arrangement of the building.

- ii. The accessibility and traffic patterns for persons and vehicles, the type and volume of such traffic, and the adequacy of proposed off-street parking and loading;

The width of the walk, combined with the setback of the 17 to 21 inch setback of the ATM, would be adequate to allow customers to queue when waiting to use the ATM while still allowing ample room for pedestrian circulation. Customers queuing for the existing ATM do not block the sidewalk or interfere with pedestrian traffic.

- iii. The safeguards afforded to prevent noxious or offensive emissions such as noise, glare, dust and odor;

The financial service use proposed for this project would not generate nuisance levels of noise, glare, dust, and odor.

- iv. Treatment given, as appropriate, to such aspects as landscaping, screening, open spaces, parking and loading areas, service areas, lighting and signs;

The project replaces an existing ATM with a slightly larger ATM and would not change the landscaping, screening, open spaces, parking and loading areas, service areas, or lighting on the property.

- C. That the use as proposed will comply with the applicable provisions of the Planning Code and will not adversely affect the General Plan.

The project complies with all relevant requirements and standards of the Planning Code and is consistent with objectives and policies of the General Plan as detailed below.

- D. That the use as proposed would provide development that is in conformity with the purpose of the applicable Neighborhood Commercial District.

The proposed project is consistent with the stated purposes of Glen Park Neighborhood Commercial Transit District in that the project would provide convenient financial services for the adjacent neighborhood. The sidewalk in front of the Project Site is approximately nine feet wide. The width of the walk, combined with the setback of the ATM, would be adequate to allow customers to queue when waiting to use the ATM while still allowing ample room for pedestrian circulation. Customers queuing for the existing ATM do not block the sidewalk or interfere with pedestrian traffic.

- 8. **General Plan Compliance.** The Project is, on balance, consistent with the following Objectives and Policies of the General Plan:

COMMERCE AND INDUSTRY ELEMENT

Objectives and Policies

OBJECTIVE 1:

MANAGE ECONOMIC GROWTH AND CHANGE TO ENSURE ENHANCEMENT OF THE TOTAL CITY LIVING AND WORKING ENVIRONMENT.

Policy 1.1:

Encourage development which provides substantial net benefits and minimizes undesirable consequences. Discourage development that has substantial undesirable consequences that cannot be mitigated.

Policy 1.2:

Assure that all commercial and industrial uses meet minimum, reasonable performance standards.

The project would provide net benefits because the proposed use would maintain the available options for financial services in the area to the benefit of both area merchants and residents. The use would not cause substantial undesirable consequences, as there are few financial service businesses in the area. In addition, the project would not cause substantial undesirable consequences because the setback of the ATM, combined with the width of the sidewalk on Diamond Street, is adequate to allow a customer queue that would not interfere with pedestrian circulation.

OBJECTIVE 6:

MAINTAIN AND STRENGTHEN VIABLE NEIGHBORHOOD COMMERCIAL AREAS EASILY ACCESSIBLE TO CITY RESIDENTS.

Policy 6.1:

Ensure and encourage the retention and provision of neighborhood-serving goods and services in the city's neighborhood commercial districts, while recognizing and encouraging diversity among the districts.

Policy 6.2:

Promote economically vital neighborhood commercial districts which foster small business enterprises and entrepreneurship and which are responsive to the economic and technological innovation in the marketplace and society.

The project would replace a neighborhood serving financial service. The proposed use would maintain the available options for financial services in the area to the benefit of both area merchants and residents. The project would promote economic viability in the area by maintaining existing financial services to area residents and businesses.

9. **Planning Code Section 101.1(b)** establishes eight priority-planning policies and requires review of permits for consistency with said policies. On balance, the project does comply with said policies in that:

- A. That existing neighborhood-serving retail uses be preserved and enhanced and future opportunities for resident employment in and ownership of such businesses be enhanced.

The proposal would enhance the district by providing maintaining a financial service in an area that would not be well served with such uses with the elimination of the existing ATM.

- B. That existing housing and neighborhood character be conserved and protected in order to preserve the cultural and economic diversity of our neighborhoods.

The project would not affect existing housing in the area. The project would complement and strengthen the character of the surrounding neighborhood commercial district and maintain existing financial services available to area merchants and residents.

- C. That the City's supply of affordable housing be preserved and enhanced,

No housing is removed for this project.

- D. That commuter traffic not impede MUNI transit service or overburden our streets or neighborhood parking.

The sidewalk in front of the Project Site is approximately nine feet wide. The width of the walk, combined with the setback of the ATM, would be adequate to allow customers to queue when waiting to use the ATM while still allowing ample room for pedestrian circulation. Customers queuing for the existing ATM do not block the sidewalk or interfere with pedestrian traffic.

- E. That a diverse economic base be maintained by protecting our industrial and service sectors from displacement due to commercial office development, and that future opportunities for resident employment and ownership in these sectors be enhanced.

The project would not displace any service or industry establishment. The project would not affect industrial or service sector uses or related employment opportunities. Ownership of industrial or service sector businesses would not be affected by this project.

- F. That the City achieve the greatest possible preparedness to protect against injury and loss of life in an earthquake.

The project is designed and would be constructed to conform to the structural and seismic safety requirements of the City Building Code.

- G. That landmarks and historic buildings be preserved.

A landmark or historic building does not occupy the Project site.

- H. That our parks and open space and their access to sunlight and vistas be protected from development.

The project would have no negative affect on existing parks and open spaces.

10. The Project is consistent with and would promote the general and specific purposes of the Code provided under Section 101.1(b) in that, as designed, the Project would contribute to the character and stability of the neighborhood and would constitute a beneficial development.
11. The Commission hereby finds that approval of the Conditional Use authorization would promote the health, safety and welfare of the City.

DECISION

That based upon the Record, the submissions by the Applicant, the staff of the Department and other interested parties, the oral testimony presented to this Commission at the public hearings, and all other written materials submitted by all parties, the Commission hereby **APPROVES Conditional Use Application No. 2012.1142C** subject to the following conditions attached hereto as "EXHIBIT A" in general conformance with plans on file, dated August 31, 2012, and stamped "EXHIBIT B", which is incorporated herein by reference as though fully set forth.

APPEAL AND EFFECTIVE DATE OF MOTION: Any aggrieved person may appeal this Conditional Use Authorization to the Board of Supervisors within thirty (30) days after the date of this Motion No. XXXXX. The effective date of this Motion shall be the date of this Motion if not appealed (After the 30-day period has expired) OR the date of the decision of the Board of Supervisors if appealed to the Board of Supervisors. For further information, please contact the Board of Supervisors at (415) 554-5184, City Hall, Room 244, 1 Dr. Carlton B. Goodlett Place, San Francisco, CA 94102.

I hereby certify that the Planning Commission ADOPTED the foregoing Motion on November 29, 2012.

Jonas P. Ionin
Acting Commission Secretary

AYES:

NAYS:

ABSENT:

ADOPTED: November 29, 2012

EXHIBIT A

AUTHORIZATION

This authorization is for a conditional use to allow a Walk-Up Facility located at 2815 Diamond Street, Block 6745, and Lot 074, pursuant to Planning Code Section 3 303 and 738.26 within the Glen Park Neighborhood Commercial Transit District and a 40-X Height and Bulk District; in general conformance with plans, dated August 31, 2012, and stamped "EXHIBIT B" included in the docket for Case No. 2011.1142C and subject to conditions of approval reviewed and approved by the Commission on November 29, 2012 under Motion No XXXXXX. This authorization and the conditions contained herein run with the property and not with a particular Project Sponsor, business, or operator.

RECORDATION OF CONDITIONS OF APPROVAL

Prior to the issuance of the building permit or commencement of use for the Project, the Zoning Administrator shall approve and order the recordation of a Notice in the Official Records of the Recorder of the City and County of San Francisco for the subject property. This Notice shall state that the project is subject to the conditions of approval contained herein and reviewed and approved by the Planning Commission on November 29, 2012 under Motion No XXXXXX.

PRINTING OF CONDITIONS OF APPROVAL ON PLANS

The conditions of approval under the 'Exhibit A' of this Planning Commission Motion No. XXXXXX shall be reproduced on the Index Sheet of construction plans submitted with the Site or Building permit application for the Project. The Index Sheet of the construction plans shall reference to the Conditional Use authorization and any subsequent amendments or modifications.

SEVERABILITY

The Project shall comply with all applicable City codes and requirements. If any clause, sentence, section or any part of these conditions of approval is for any reason held to be invalid, such invalidity shall not affect or impair other remaining clauses, sentences, or sections of these conditions. This decision conveys no right to construct, or to receive a building permit. "Project Sponsor" shall include any subsequent responsible party.

CHANGES AND MODIFICATIONS

Changes to the approved plans may be approved administratively by the Zoning Administrator. Significant changes and modifications of conditions shall require Planning Commission approval of a new Conditional Use authorization.

Conditions of Approval, Compliance, Monitoring, and Reporting

PERFORMANCE

1. **Validity and Expiration.** The authorization and right vested by virtue of this action is valid for three years from the effective date of the Motion. A building permit from the Department of

Building Inspection to construct the project and/or commence the approved use must be issued as this Conditional Use authorization is only an approval of the proposed project and conveys no independent right to construct the project or to commence the approved use. The Planning Commission may, in a public hearing, consider the revocation of the approvals granted if a site or building permit has not been obtained within three (3) years of the date of the Motion approving the Project. Once a site or building permit has been issued, construction must commence within the timeframe required by the Department of Building Inspection and be continued diligently to completion. The Commission may also consider revoking the approvals if a permit for the Project has been issued but is allowed to expire and more than three (3) years have passed since the Motion was approved.

For information about compliance, contact Code Enforcement, Planning Department at 415-575-6863, www.sf-planning.org.

2. **Extension.** This authorization may be extended at the discretion of the Zoning Administrator only where failure to issue a permit by the Department of Building Inspection to perform said tenant improvements is caused by a delay by a local, State or Federal agency or by any appeal of the issuance of such permit(s).

For information about compliance, contact Code Enforcement, Planning Department at 415-575-6863, www.sf-planning.org.

DESIGN – COMPLIANCE AT PLAN STAGE

3. **Canopy.** The proposed canopy at the top of the ATM unit shall not extend beyond any property line of the subject property.

For information about compliance, contact the Case Planner, Planning Department at 415-558-6378, www.sf-planning.org

MONITORING

4. **Enforcement.** Violation of any of the Planning Department conditions of approval contained in this Motion or of any other provisions of Planning Code applicable to this Project shall be subject to the enforcement procedures and administrative penalties set forth under Planning Code Section 176 or Section 176.1. The Planning Department may also refer the violation complaints to other city departments and agencies for appropriate enforcement action under their jurisdiction.

For information about compliance, contact Code Enforcement, Planning Department at 415-575-6863, www.sf-planning.org

5. **Revocation due to Violation of Conditions.** Should implementation of this Project result in complaints from interested property owners, residents, or commercial lessees which are not resolved by the Project Sponsor and found to be in violation of the Planning Code and/or the specific conditions of approval for the Project as set forth in Exhibit A of this Motion, the Zoning Administrator shall refer such complaints to the Commission, after which it may hold a public hearing on the matter to consider revocation of this authorization.

For information about compliance, contact Code Enforcement, Planning Department at 415-575-6863, www.sf-planning.org

Parcel Map

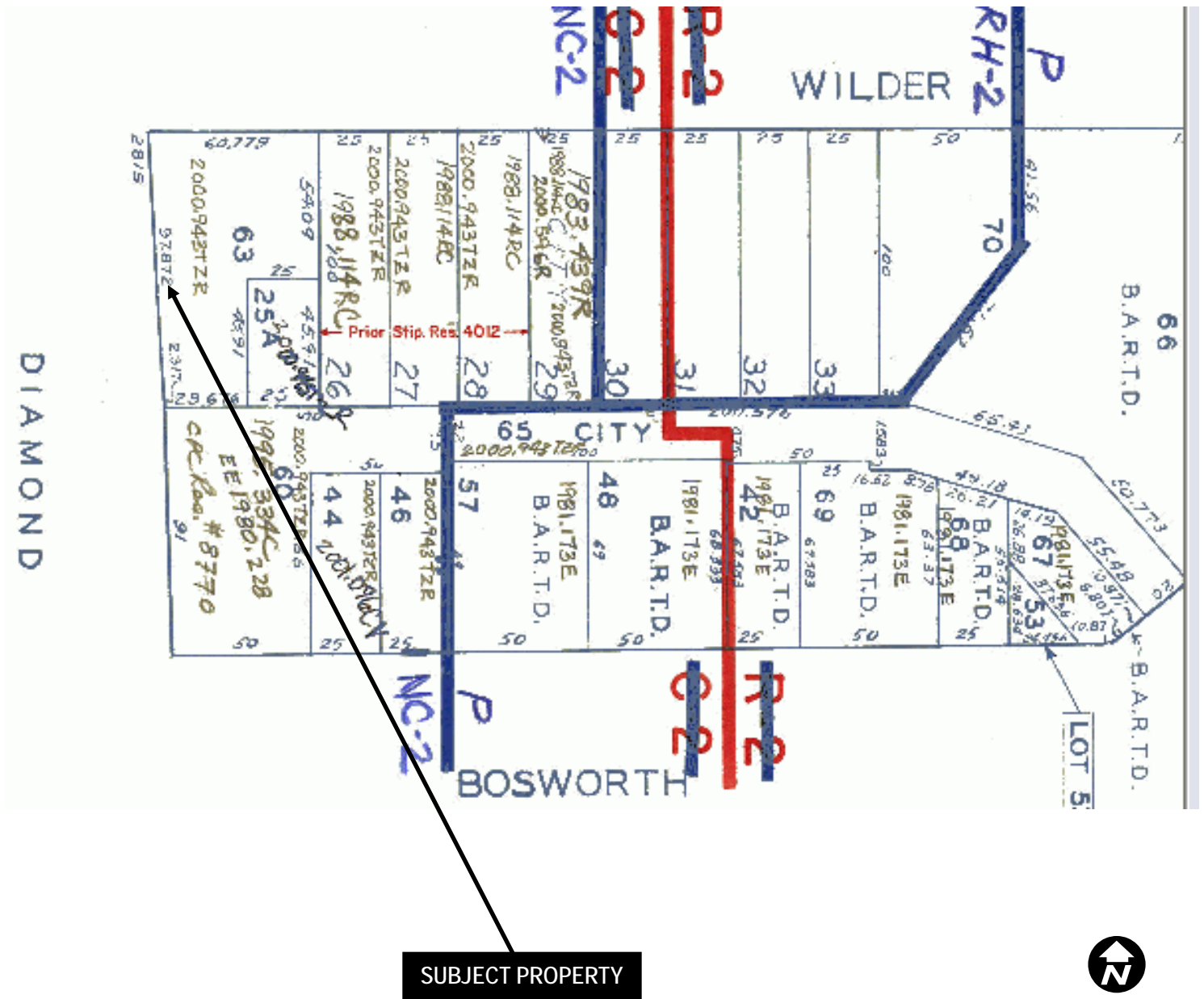

SUBJECT PROPERTY

Conditional Use Authorization
 Case Number 2012.1142C
 Wells Fargo ATM
 2815 Diamond Street

Sanborn Map*

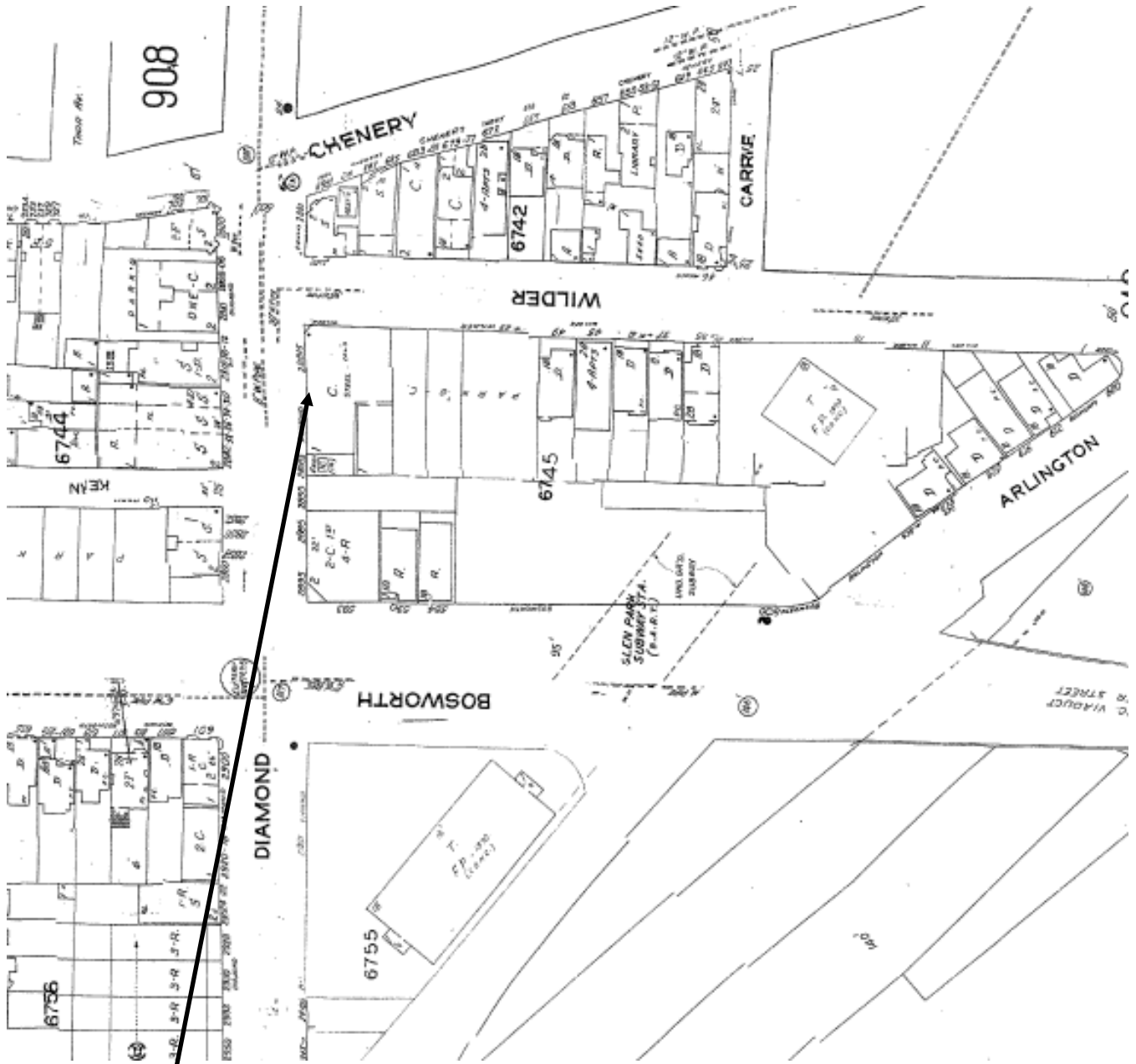

SUBJECT PROPERTY



**The Sanborn Maps in San Francisco have not been updated since 1998, and this map may not accurately reflect existing conditions.*

Conditional Use Authorization
Case Number 2012.1142C
Wells Fargo ATM
2815 Diamond Street

Zoning Map

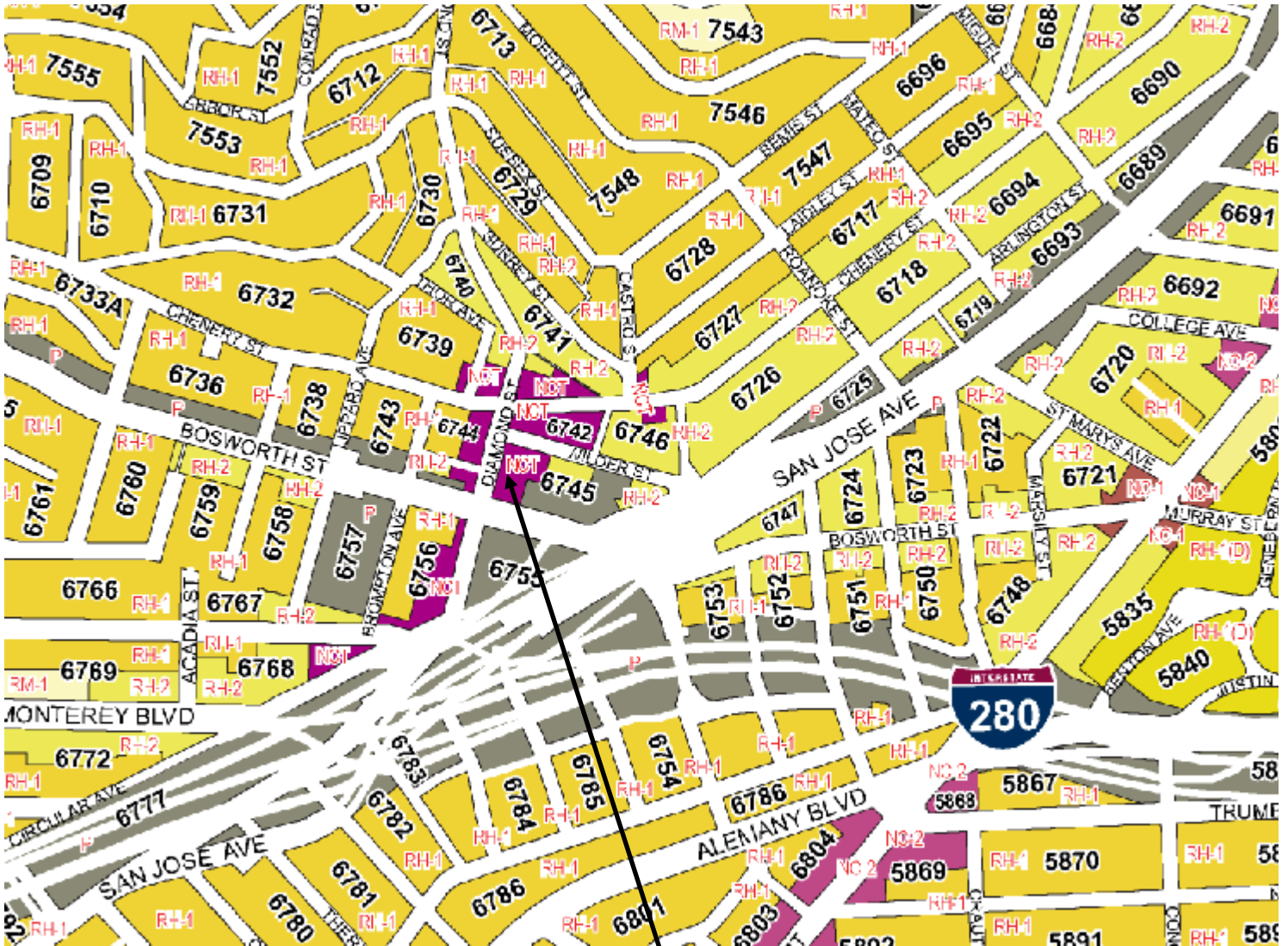

SUBJECT PROPERTY



Conditional Use Authorization
Case Number 2012.1142C
Wells Fargo ATM
2815 Diamond Street

Aerial Photo

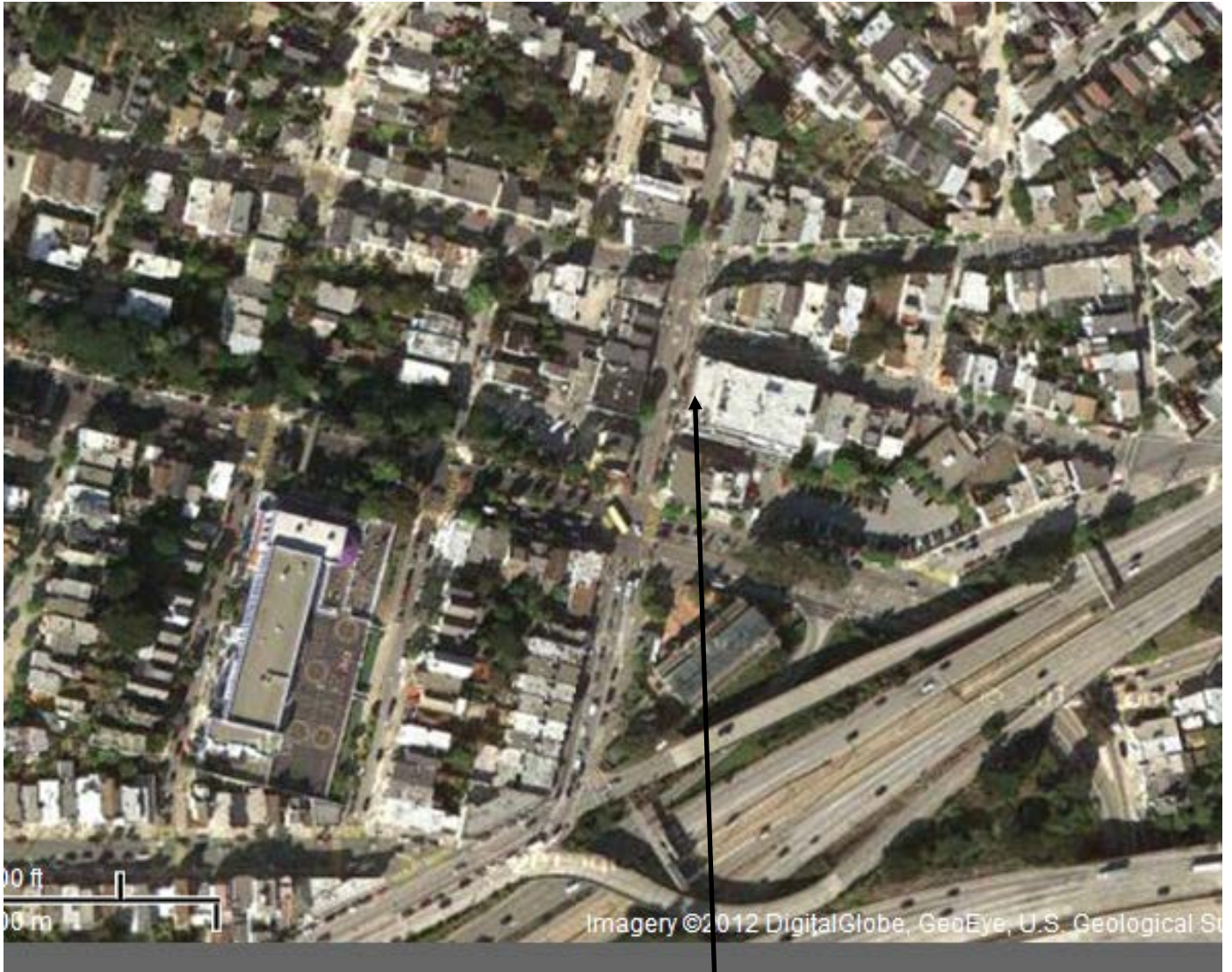

SUBJECT PROPERTY



Conditional Use Authorization
Case Number 2012.1142C
Wells Fargo ATM
2815 Diamond Street

Context Photo



Conditional Use Authorization
Case Number 2012.1142C
Wells Fargo ATM
2815 Diamond Street

Site Photos



Conditional Use Authorization
Case Number 2012.1142C
Wells Fargo ATM
2815 Diamond Street

Wells Fargo SF Tone on Tone
Glen Park 9917L



VIEW OF PROPERTY



VIEW FROM WILDER STREET



VIEW OF PROPERTY ACROSS THE STREET



VIEW OF ATM AND PROPERTY



VIEW OF ATM WITH NOTICE SIGN



VIEW ACROSS THE STREET

Wells Fargo SF Tone on Tone
Glen Park 9917L



VIEW OF BUISNESSES ACROSS THE STREET



VIEW OF BUISNESSES ACROSS THE STREET



VIEW OF BUISNESSES ACROSS THE STREET



VIEW OF SIDEWALK FACING ATM



VIEW OF ATM FROM STREET



VIEW OF NOTICE SIGN ON WILDER STREET

CHENERY STREET



EXISTING CLEANERS
 EXISTING RESTAURANT
 EXISTING GLEN PARK STATION
 EXISTING TAQUERIA
 EXISTING SOL GYM

DIAMOND STREET

EXISTING RESTARUANT
 EXISTING OFFICE SPACE
 EXISTING OFFICE SPACE

WILDER STREET

EXISTING CANYON MARKET
 ATM
 MPOE
 EXISTING WELLS FARGO BANK ATM
 EXISTING GLEN PARK LIBRARY

KERN STREET

EXISTING CITI BANK

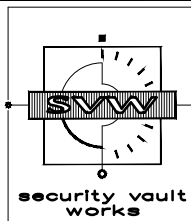

2815 DIAMOND STREET
 SAN FRANCISCO, CA 94131
 GLEN PARK 9917L

All rights reserved. Designs, drawings and specifications as instruments of service are and shall remain the property of Security Vault Works, Incorporated whether the project for which they are made is executed or not. They are not to be used by the owner on other projects or extensions to this project except by agreement in writing and with appropriate compensation to Security Vault Works, Incorporated.

TITLE: Site Plan		SCALE: NTS
DATE: 3/12/12	DRAWN BY: NRA / M	SURVEYOR: SVW

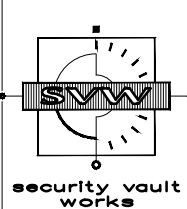
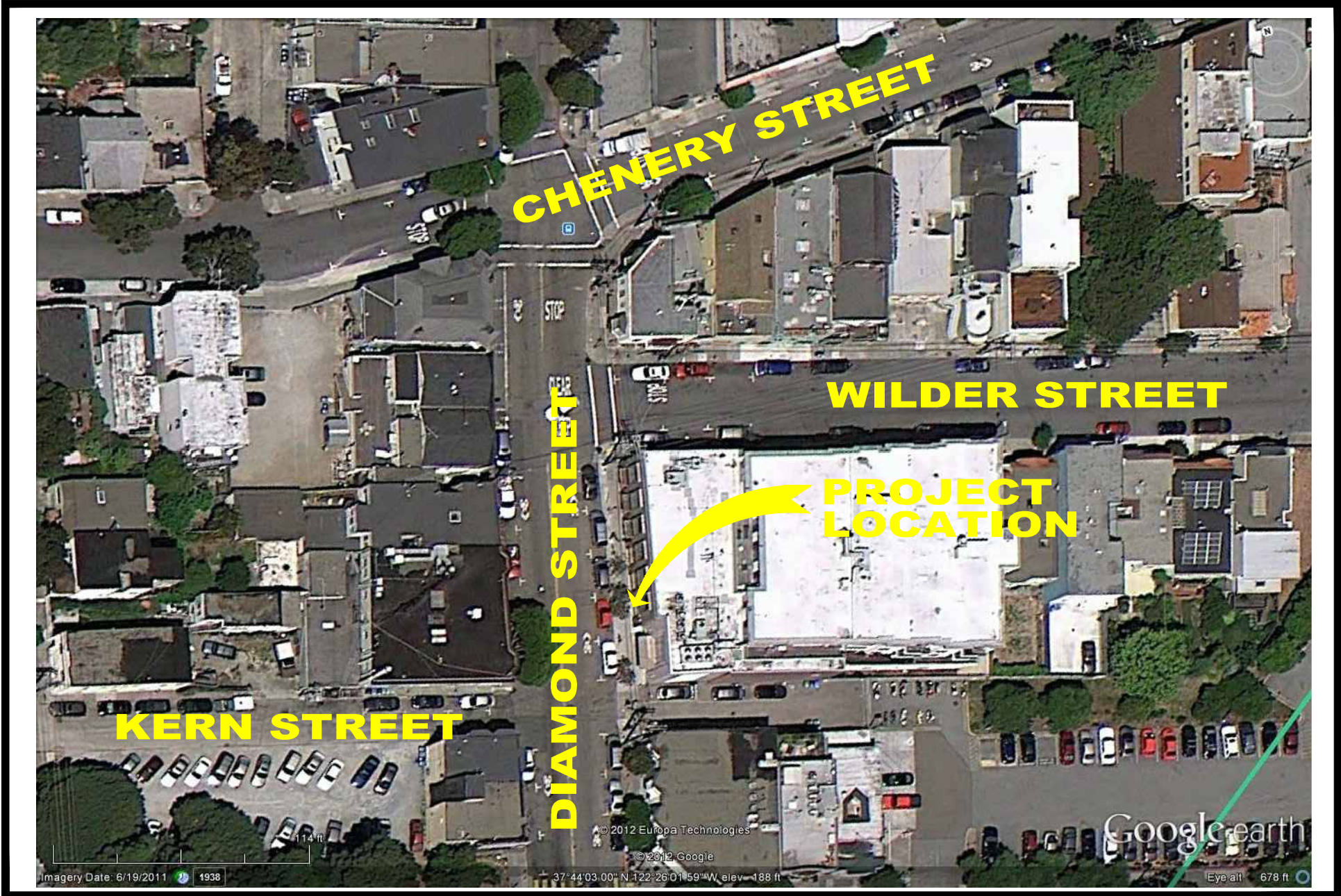

**2815 DIAMOND STREET
SAN FRANCISCO, CA 94131
GLEN PARK 9917L**

All rights reserved. Designs, drawings and specifications as instruments of service are and shall remain the property of Security Vault Works, Incorporated whether the project for which they are made is executed or not. They are not to be used by the owner on other projects or extensions to this project except by agreement in writing and with appropriate compensation to Security Vault Works, Incorporated.

TITLE: Aerial Image		SCALE: NTS
DATE: 3/12/12	DRAWN BY: NRA / M	SURVEYOR: SVW

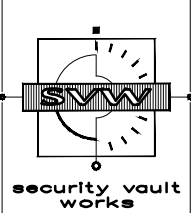
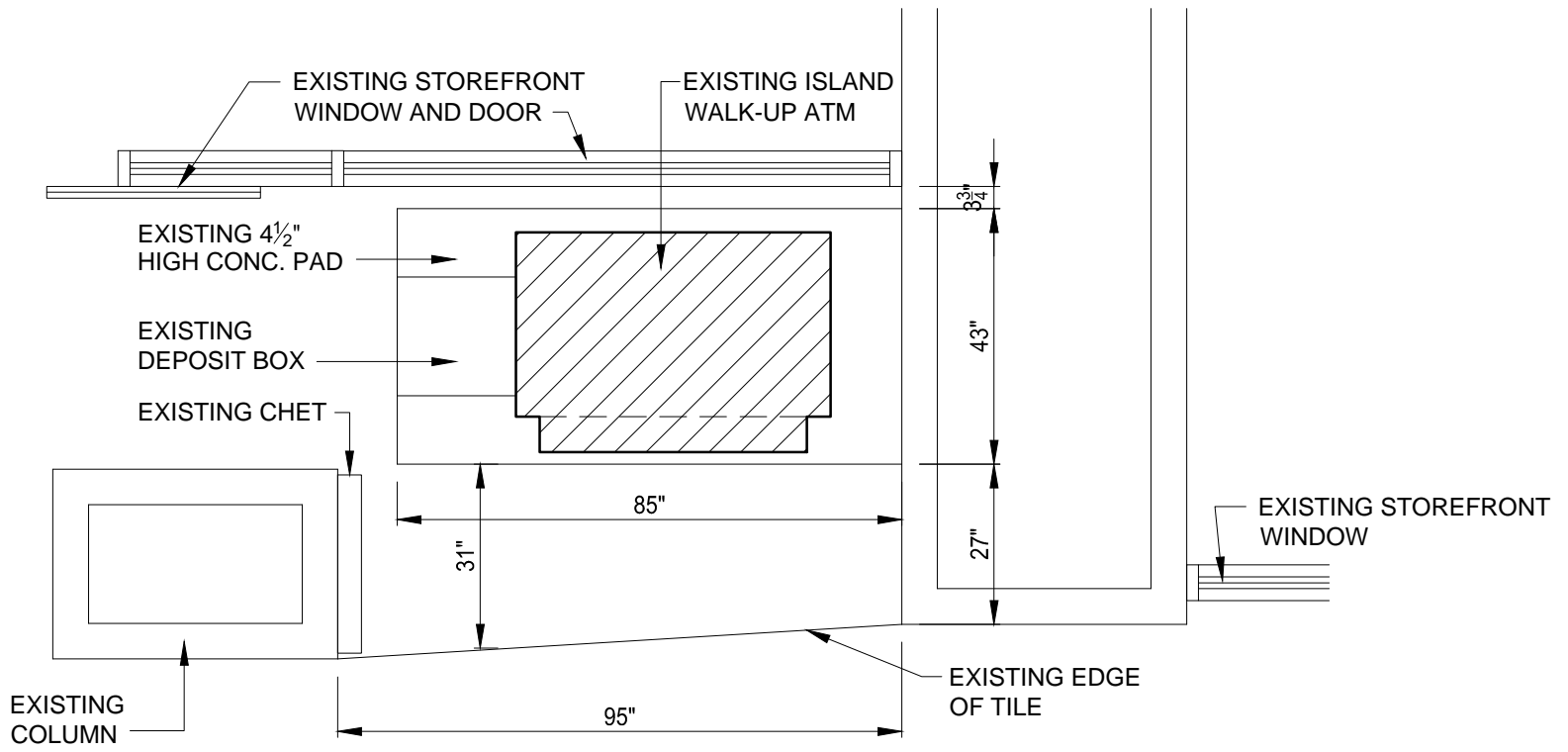

**2815 DIAMOND STREET
SAN FRANCISCO, CA 94131
GLEN PARK 9917L**

All rights reserved. Designs, drawings and specifications as instruments of service are and shall remain the property of Security Vault Works, Incorporated whether the project for which they are made is executed or not. They are not to be used by the owner on other projects or extensions to this project except by agreement in writing and with appropriate compensation to Security Vault Works, Incorporated.

TITLE: Existing Plan View		SCALE: 3/8" = 1'-0"
DATE: 3/12/12	DRAWN BY: NRA / M	SURVEYOR: SVW

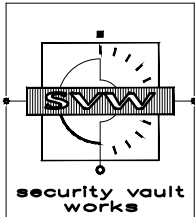
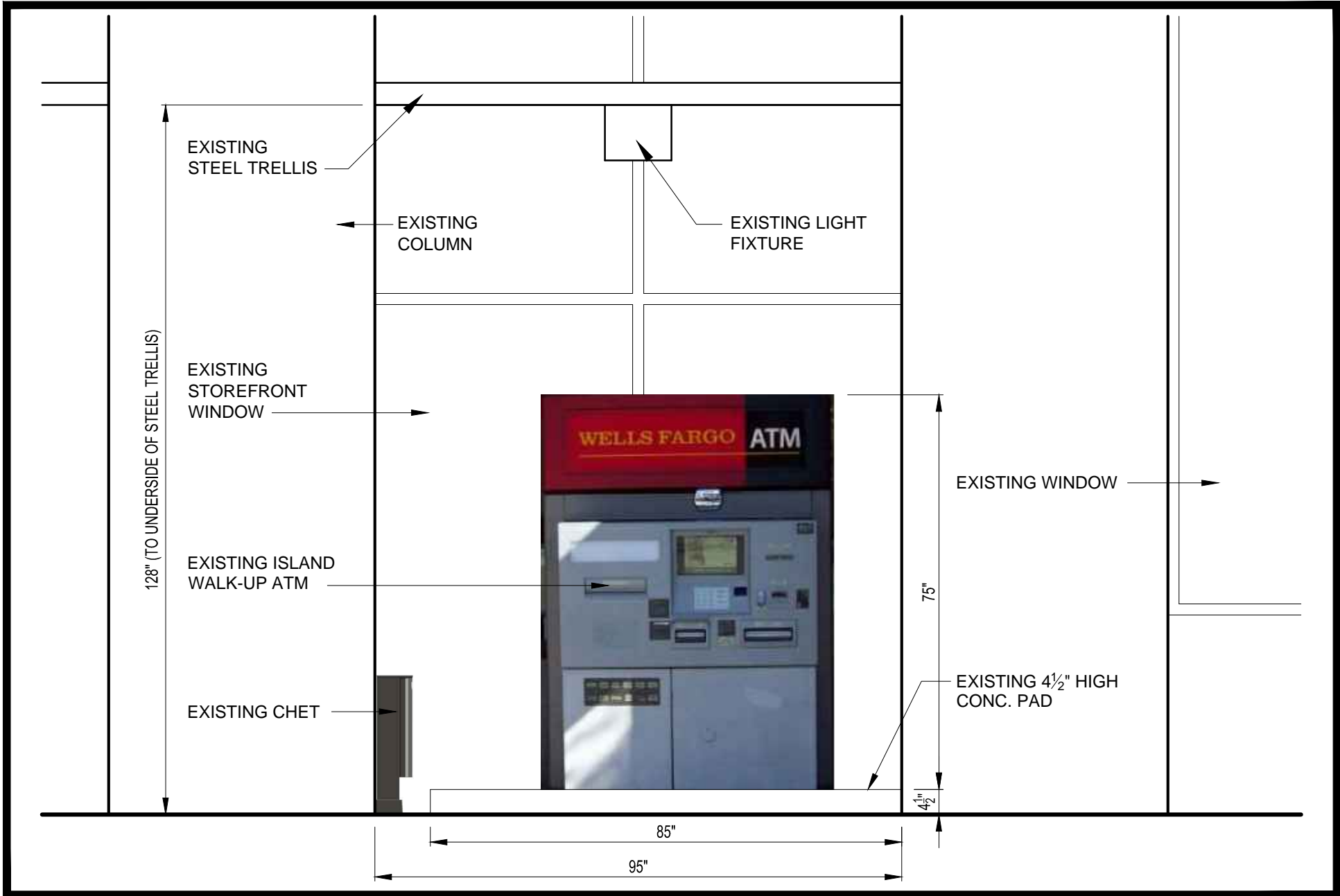

**2815 DIAMOND STREET
SAN FRANCISCO, CA 94131
GLEN PARK 9917L**

All rights reserved. Designs, drawings and specifications as instruments of service are and shall remain the property of Security Vault Works, Incorporated whether the project for which they are made is executed or not. They are not to be used by the owner on other projects or extensions to this project except by agreement in writing and with appropriate compensation to Security Vault Works, Incorporated.

TITLE: Existing Elevation		SCALE: 1/2" = 1'-0"
DATE: 3/12/12	DRAWN BY: NRA / M	SURVEYOR: SVW

NOTE:

1. EXISTING ISLAND WALK-UP ATM TO BE REMOVED TO ACCOMMODATE NEW WALK-UP ATM KIOSK AT EXISTING LOCATION.
2. EXISTING 4½" CONC. PAD TO BE DEMOLISHED AND CONC. POURED TO MATCH SIDEWALK FINISH FLOOR.

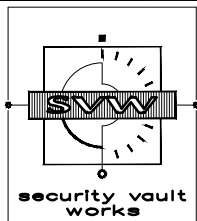
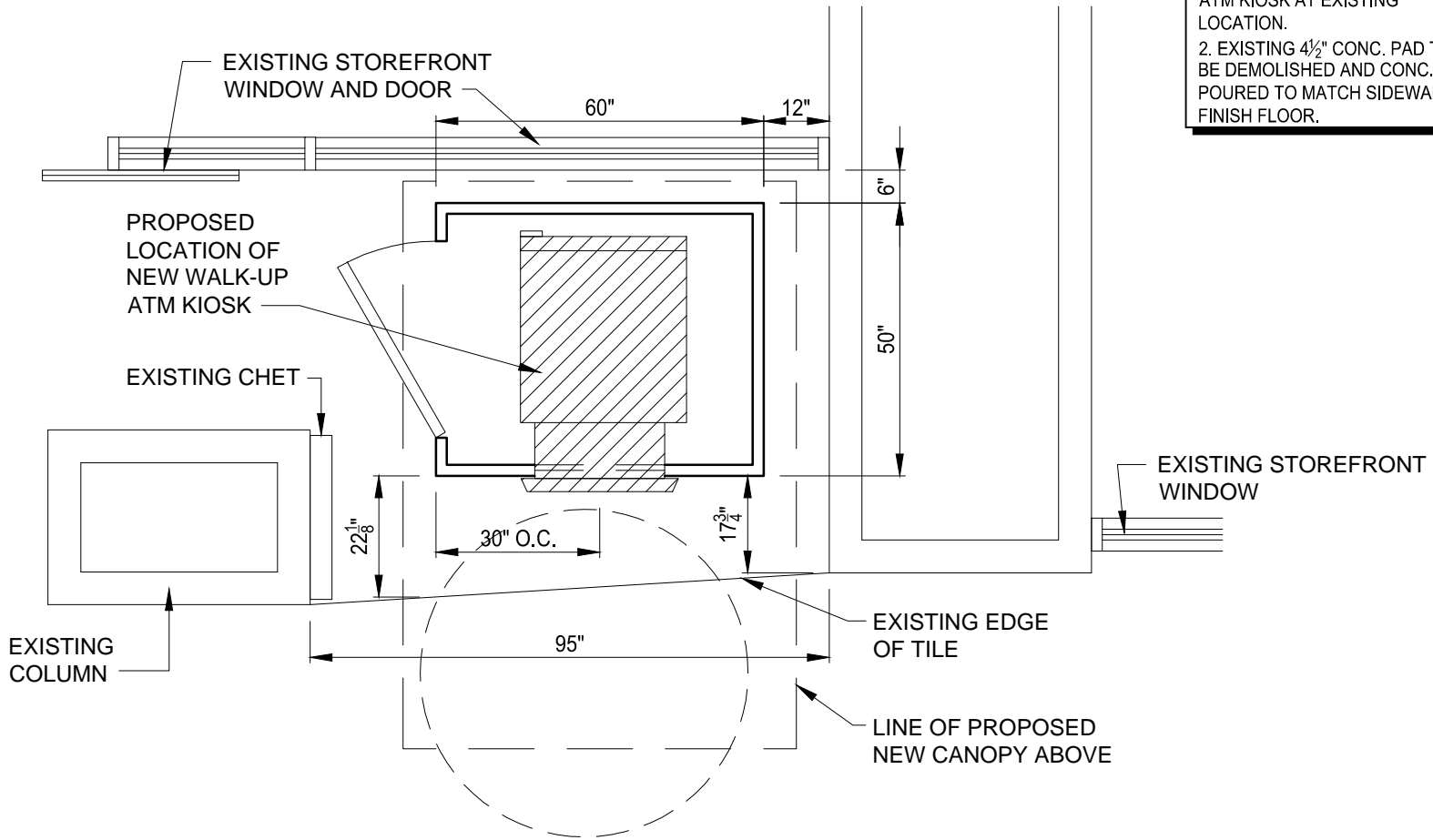

**2815 DIAMOND STREET
SAN FRANCISCO, CA 94131
GLEN PARK 9917L**

All rights reserved. Designs, drawings and specifications as instruments of service are and shall remain the property of Security Vault Works, Incorporated whether the project for which they are made is executed or not. They are not to be used by the owner on other projects or extensions to this project except by agreement in writing and with appropriate compensation to Security Vault Works, Incorporated.

TITLE: Proposed Plan View		SCALE: 3/8" = 1'-0"
DATE: 3/12/12	DRAWN BY: NRA / M	SURVEYOR: SVW

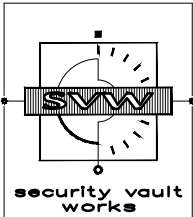
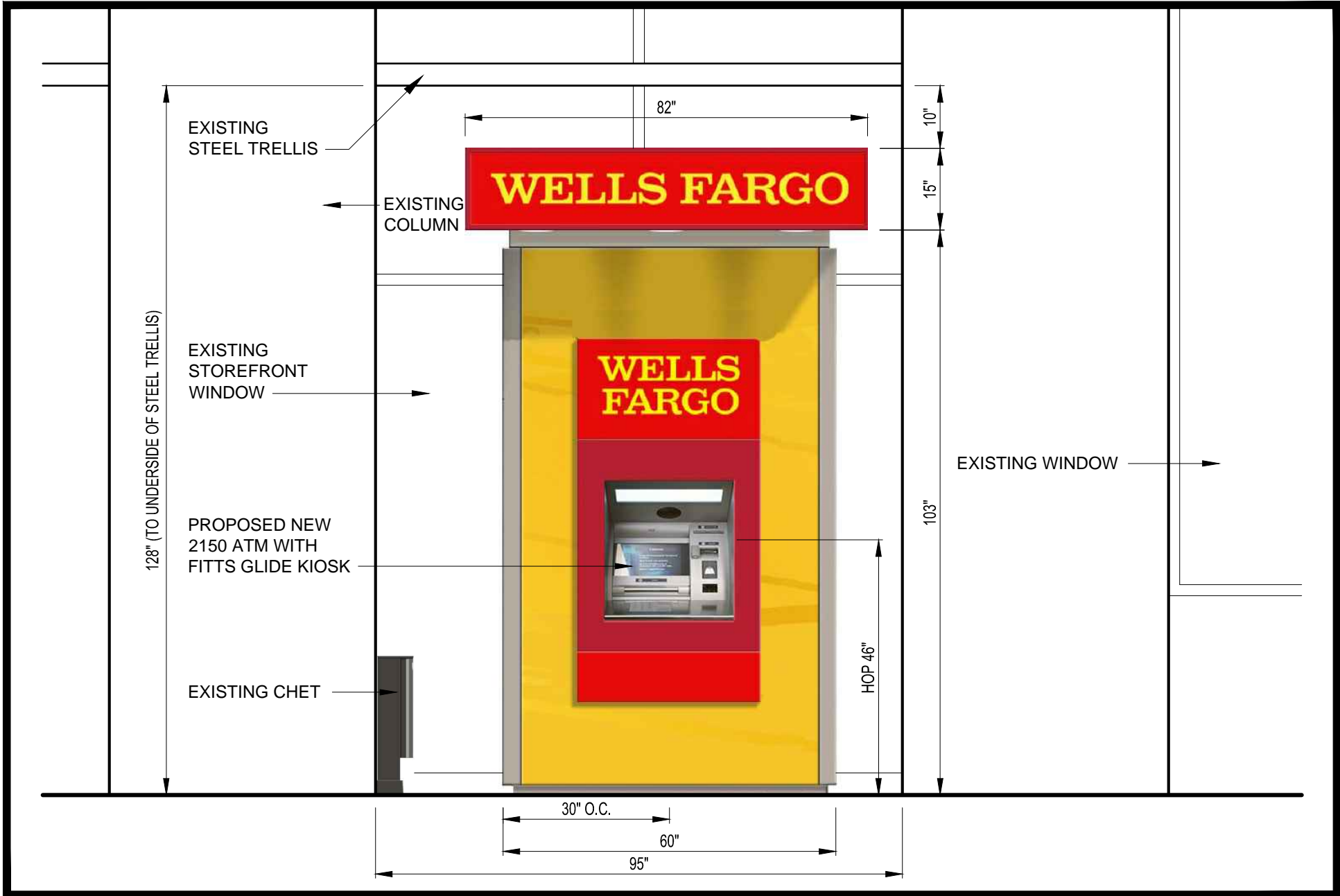

**2815 DIAMOND STREET
SAN FRANCISCO, CA 94131
GLEN PARK 9917L**

All rights reserved. Designs, drawings and specifications as instruments of service are and shall remain the property of Security Vault Works, Incorporated whether the project for which they are made is executed or not. They are not to be used by the owner on other projects or extensions to this project except by agreement in writing and with appropriate compensation to Security Vault Works, Incorporated.

TITLE: Proposed Elevation		SCALE: 1/2" = 1'-0"
DATE: 3/12/12	DRAWN BY: NRA / M	SURVEYOR: SVW

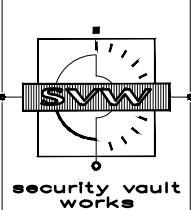

**2815 DIAMOND STREET
SAN FRANCISCO, CA 94131
GLEN PARK 9917L**

All rights reserved. Designs, drawings and specifications as instruments of service are and shall remain the property of Security Vault Works, Incorporated whether the project for which they are made is executed or not. They are not to be used by the owner on other projects or extensions to this project except by agreement in writing and with appropriate compensation to Security Vault Works, Incorporated.

TITLE: Photo Render		SCALE: NTS
DATE: 3/12/12	DRAWN BY: NRA / M	SURVEYOR: SVW