



# SAN FRANCISCO PLANNING DEPARTMENT

---

## Discretionary Review Analysis

### Medical Cannabis Dispensary

HEARING DATE: APRIL 12, 2012

*Date:* April 5, 2012  
*Case No.:* 2011.1058 D  
*Project Address:* 471 JESSIE STREET  
*Zoning:* C-3-G District  
160-F Height and Bulk District  
*Block/Lot:* 3704/028  
*Project Sponsor:* Daniel Bornstein  
Law Offices of Bornstein & Bornstein  
507 Polk Street, Suite 410  
San Francisco, CA 94102-3396  
*Staff Contact:* Elizabeth Watty – (415) 558-6620  
[Elizabeth.Watty@sfgov.org](mailto:Elizabeth.Watty@sfgov.org)  
*Recommendation:* **Take Discretionary Review and Disapprove**

1650 Mission St.  
Suite 400  
San Francisco,  
CA 94103-2479

Reception:  
**415.558.6378**

Fax:  
**415.558.6409**

Planning  
Information:  
**415.558.6377**

### PROJECT DESCRIPTION

The proposal is to establish a new Medical Cannabis Dispensary (dba “JM Collective”) at 471 Jessie Street. No physical expansion is proposed for the structure, although façade and interior alterations are proposed. The proposed Medical Cannabis Dispensary (MCD) would sell cannabis but would not allow the sale of cannabis foodstuffs, or on-site cultivation, smoking or vaporizing.

Planning Code Section 217(k) states that all MCDs are required to be heard by the Planning Commission, which will consider whether or not to exercise their discretionary review powers over the building permit application.

### SITE DESCRIPTION AND PRESENT USE

The project site is improved with a three-story industrial building, built circa 1912, on a lot that measures 1,750 sf. The lot has approximately 25'-0" of frontage and a depth of approximately 70'-0". The three-story building contains approximately 4,650 sf of floor area in total, but the ground floor commercial space that will be dedicated to the MCD measures approximately 1,340 sf, with 782sf accessible to customers. The building is currently vacant, but was most recently used for garment manufacturing, dba Rose Cage Ink, Inc.

### SURROUNDING PROPERTIES AND NEIGHBORHOOD

The project site is located in the South of Market neighborhood, just south of the Union Square/Downtown area, on the south side of Jessie Street in the block bounded by Mint Plaza, Mission Street, 6<sup>th</sup> Street, and Jessie Street. The subject block along Jessie Street, south side, consists of mixed-use buildings that are one- to five-stories tall. Many of the mixed-use buildings fronting the south side of Jessie Street are the rear façades of or garage access to buildings that front Mission Street. On the north

side of Jessie Street, directly across the street from the Subject Property, is a PG&E facility that is fenced-off at the street. Other properties on the north side of Jessie Street, between Mint Plaza and 6<sup>th</sup> Street, include a public surface parking lot, a one story structure that contains Mezzanine night club, and a five story mixed-use building that anchors Jessie Street at Mint Plaza.

The subject property is located in the C-3-G District. This District, in general, covers the western portions of Downtown and is composed of a variety of uses: retail, offices, hotels, entertainment, clubs and institutions, and high-density residential. Many of these uses have a Citywide or regional function, although the intensity of development is lower than in the Downtown core area.

The subject property is also located within the “Business Study Area” of the Central Market Economic Strategy Project, which generally spans from the north side of Market Street to the north side of Mission Street, between 5<sup>th</sup> and 10<sup>th</sup> Streets. The Central Market Economic Strategy Project was a 10 month community planning process designed to revitalize the Central Market Neighborhood, by increasing economic opportunities for residents, improving the selection and quality of retail in the neighborhood, and by restoring Central Market as San Francisco’s downtown arts district. The result of this 10 month planning effort was the Central Market Action Plan, which provides a framework for achieving these objectives.

## **ISSUES AND OTHER CONSIDERATIONS**

The Central Market Action Plan identifies MCDs, along with liquor stores, adult uses, and pawn shops, as “nuisance uses” that should be more heavily regulated in order to ensure a balance of uses in the district.

Concerns have been expressed in the press regarding an over-concentration of Medical Cannabis Dispensaries in the Mid-Market area. Since the Planning Code prohibits MCDs from being located within 1,000 feet of any parcel containing the grounds of an elementary or secondary school, public or private, or recreation buildings, neighborhoods such as Central Market and South of Market, which have historically been developed for industrial and commercial uses, have a greater number of MCD establishments.

The neighborhood surrounding the project site contains several MCDs within close walking proximity:

- Grassroots, 952 Mission St.(3704/017), between Mint Plaza and 6th Street (0.1 miles)<sup>1</sup>
- The Green Door, 843 Howard Street(3733/082), between 4th and 5th Streets (0.4 miles)
- SPARC, 1252 Mission Street (3701/008), between 8th and 9th Streets (0.5 miles)
- Herbal Re-Leaf, 1288 Mission Street (3701/022), near Ninth Street (0.5 miles)
- Hopenet Co-Op, 225 – 9th Street (3729/079), between Howard and Tehama Streets (0.7 miles)
- SF Medical Cannabis Clinic #1, 122 – 10th St. (3510/059), between Mission and Minna Sts. (0.7 miles)
- 70 – 2<sup>nd</sup> Street (3707/009), between 2nd and New Montgomery Streets (0.7 miles )<sup>2</sup>
- Igzactly Health Center, 529 Howard St. (3736/083), between 1st and 2nd Streets (0.9 miles)

The proposed dispensary complies with all other relevant Planning Code requirements, in that it is not within 1000’ of a school or recreation building primarily geared toward children 18 years-of-age or under.

---

<sup>1</sup> Permitted, but has not yet opened.

<sup>2</sup> Permitted, but has not yet opened.

**HEARING NOTIFICATION**

TYPE	REQUIRED PERIOD	REQUIRED NOTICE DATE	ACTUAL NOTICE DATE	ACTUAL PERIOD
Posted Notice	30 days	March 13, 2012	March 13, 2012	30 days
Mailed Notice	30 days	March 13, 2012	March 13, 2012	30 days

**PUBLIC COMMENT**

	SUPPORT	OPPOSED	NO POSITION
Adjacent neighbor(s)	0	0	0
Other neighbors on the block or directly across the street		1	
Neighborhood groups or others	0	2	0

The Department has received five letters and one phone call in opposition to the Project, including letters in opposition to the Project from the Central Market Community Benefit District and the Howard Street Clean and Green Neighborhood Association. The Department has also received opposition to the project from City’s Office of Economic and Workforce Development. To date, the Department has not received any support for the project.

**PROJECT ANALYSIS**

**MEDICAL CANNABIS DISPENSARY CRITERIA**

Below are the six criteria to be considered by the Planning Commission in evaluating Medical Cannabis Dispensaries, per Planning Code Section 217(k):

1. That the proposed site is located not less than 1,000 feet from the parcel containing the grounds of an elementary or secondary school, public or private, or recreation buildings as defined by Section 221(e) of the Planning Code.

***Project Meets Criteria***

*The subject property is not located within 1000’ of an elementary or secondary school, public or private, or an active recreation or community center building which primarily serves persons 18 years or less.*

2. The parcel containing the MCD cannot be located on the same parcel as a facility providing substance abuse services that is licensed or certified by the State of California or funded by the Department of Public Health.

***Project Meets Criteria***

*The subject parcel does not contain a facility providing substance abuse services that is licensed or certified by the State of California or funded by the Department of Public Health.*

3. No alcohol is sold or distributed on the premises for on or off site consumption.

***Project Meets Criteria***

*No alcohol is sold or distributed on the premises for on or off-site consumption.*

4. If Medical Cannabis is smoked on the premises the dispensary shall provide adequate ventilation within the structure such that doors and/or windows are not left open for such purposes resulting in odor emission from the premises.

***Criteria not Applicable***

*The establishment of a new MCD at the subject site would not include an on-site smoking area.*

5. The Medical Cannabis Dispensary has applied for a permit from the Department of Public Health pursuant to Section 3304 of the San Francisco Health Code.

***Project Meets Criteria***

*The applicant has applied for a permit from the Department of Public Health.*

6. A notice shall be sent out to all properties within 300-feet of the subject lot and individuals or groups that have made a written request for notice or regarding specific properties, areas or Medical Cannabis Dispensaries. Such notice shall be held for 30 days.

***Project Meets Criteria***

*A 30-day notice was sent to owners and occupants within 300-feet of the subject property identifying that a MCD is proposed at the subject property and that the building permit was subject to a Mandatory Discretionary Review Hearing.*

**GENERAL PLAN COMPLIANCE:**

The Project is, on balance, inconsistent with the following Objectives and Policies of the General Plan:

**COMMERCE AND INDUSTRY**

**Objectives and Policies**

**OBJECTIVE 1:**

MANAGE ECONOMIC GROWTH AND CHANGE TO ENSURE ENHANCEMENT OF THE TOTAL CITY LIVING AND WORKING ENVIRONMENT.

**Policy 1.1:**

Encourage development which provides substantial net benefits and minimizes undesirable consequences. Discourage development which has substantial undesirable consequences that cannot be mitigated.

*The proposed MCD would not provide substantial net benefits to the surrounding neighborhood, and as a "nuisance use", as defined in the Central Market Action Plan, it would exacerbate undesirable consequences. One of the key concerns of stakeholders during the community planning process of the Central Market Economic Strategy was public safety: stakeholders reported feeling unsafe in the*



*neighborhood, and expressed concern about the high level of criminal activity. The proposed MCD is not consistent with the revitalization strategy outlined in the Central Market Economic Strategy.*

**OBJECTIVE 2**

MAINTAIN AND ENHANCE A SOUND AND DIVERSE ECONOMIC BASE AND FISCAL STRUCTURE FOR THE CITY.

**Policy 2.1:**

Seek to retain existing commercial and industrial activity and to attract new such activity to the city.

**Policy 2.3**

Maintain a favorable social and cultural climate in the city in order to enhance its attractiveness as a firm location.

*The proposed MCD would occupy a space that although currently vacant, was most recently an industrial garment manufacturing business. The subject property is part of the Business Study Area of the Central Market Economic Strategy, which focused on improving the business climate within the Central Market area. MCDs were identified in the Central Market Economic Strategy as one of the uses that do not favorably contribute to the social and cultural climate in the neighborhood, which in turn make the neighborhood a less attractive location for new businesses to locate.*

**OBJECTIVE 4**

IMPROVE THE VIABILITY OF EXISTING INDUSTRY IN THE CITY AND THE ATTRACTIVENESS OF THE CITY AS A LOCATION FOR NEW INDUSTRY.

**Policy 4.2**

Promote and attract those economic activities with potential benefit to the City.

**Policy 4.10**

Enhance the working environment within industrial areas.

*The proposed MCD would detract from the attractiveness of the Central Market neighborhood as a location for new industry. The use would not enhance the working environment, and would occupy a storefront that could otherwise be occupied by a neighborhood-serving use.*

**SECTION 101.1 PRIORITY POLICIES**

Planning Code Section 101.1 establishes eight priority policies and requires review of permits for consistency, on balance, with these policies. The Project does not comply with all of these policies, as follows:

1. Existing neighborhood-serving retail uses be preserved and enhanced and future opportunities for resident employment in and ownership of such businesses enhanced.

*The proposed use is not seen as a neighborhood-serving retail use, as it has been identified through the Central Market Economic Strategy as a "nuisance use." By locating such a "nuisance use" within a vacant commercial storefront, it prohibits neighborhood-serving retail uses from occupying the space.*

2. That existing housing and neighborhood character be conserved and protected in order to preserve the cultural and economic diversity of our neighborhoods.

*Although this Project would not directly affect any housing, it would adversely affect the neighborhood character, and therefore affect the cultural and economic diversity of the surrounding neighborhood. The Central Market Economic Strategy report was the result of a more than 10 month community planning process, which involved a cross-section of key stakeholders from throughout the community, including residents, property owners, business owners, and participants from the City family. Through this lengthy, inclusive process, several objectives were identified, including Objective 6 of the Central Market Action Plan, which seeks to improve safety, in order to enhance the quality of life and desirability of Central Market for residents, workers, shoppers and visitors, and to reduce crime rates in the neighborhood to be in line with citywide averages. MCDs were identified as nuisance uses that do not contribute positively to the safety, quality of life, or desirability of the Central Market area.*

3. That the City's supply of affordable housing be preserved and enhanced.

*Increasing the quantity of "nuisance uses" within the neighborhood would not enhance the City's supply of affordable housing.*

4. That commuter traffic not impede MUNI transit service or overburden our streets or neighborhood parking.

*The Project would not adversely affect commuter traffic, nor would it be expected to overburden the streets or neighborhood parking. The project site is close to multiple public transit lines.*

5. A diverse economic base be maintained by protecting our industrial and service sectors from displacement due to commercial office development, and that future opportunities for resident employment and ownership in these sectors be enhanced.

*Although the Project is not a commercial office development, the previous tenant was an industrial garment manufacturing business, and the proposed MCD would prevent future opportunities for resident employment and ownership in the service sector business sector by preventing a retail use from occupying this storefront.*

6. The City achieves the greatest possible preparedness to protect against injury and loss of life in an earthquake.

*Any construction associated with this Project would comply with contemporary building and seismic codes.*

7. Landmarks and historic buildings be preserved.

*The proposed façade alterations to the existing building have been reviewed by the Department's historic preservation staff and determined to be compatible with the Secretary of the Interior's Standards for the Treatment of Historic Properties.*

8. Parks and open space and their access to sunlight and vistas be protected from development.

*The Project will not include any exterior expansion, and will thus not adversely affect any open space or parks, or their access to sunlight or vistas.*

## ENVIRONMENTAL REVIEW

The Project is exempt from the California Environmental Quality Act ("CEQA") as a Class 1 categorical exemption.

## BASIS FOR RECOMMENDATION

- According to Mayor Lee, "Central Market is key to San Francisco's future as a vibrant, diverse, and economically thriving City. The neighborhood is at a crossroads: we now have a historic opportunity to restore Central Market to its position as a vital commercial center. By leveraging our recent successes in the neighborhood and building on existing community assets, we can create jobs and increase the quality of life for all residents."
- The subject property is unique in that this property is located within an area that recently underwent a 10-month community planning process, where MCDs were identified as "nuisance uses".
- Achieving the Objectives outlined in the Central Market Action Plan will require the City's decision makers to make small, incremental steps that will cumulatively improve the business environment and quality of life for all residents of the neighborhood. The Department finds the disapproval of the proposed MCD to be one of those positive incremental steps necessary to fully implement the Objectives of the Central Market Economic Strategy and to ensure a balance of neighborhood-serving uses.
- Although individuals are permitted to apply for new MCDs when there are no constraints associated with the establishment's proximity to schools or recreation centers, it does not mean that a proposed MCD will always be appropriate, given the unique context of every neighborhood. Just as the Commission may use its discretionary powers to disapprove principally permitted residential projects, the Commission too may use its discretionary powers to disapprove an MCD, if "exceptional or extraordinary" circumstances exist. The Department finds that there are exceptional and extraordinary circumstances associated with the proposed project, due to the Objectives defined through the Central Market community planning effort and the abundance of other MCDs in the surrounding area.
- The proposed MCD is located in a neighborhood that already contains ample access to medical cannabis, thus disapproval of this project will not prevent patients from accessing medical cannabis.

## RECOMMENDATION

**RECOMMENDATION: Take Discretionary Review and Disapprove the MCD**

**Attachments:**

Letters in Opposition  
Applicant's MCD Application  
Block Book Map  
Sanborn Map  
Zoning Map  
Aerial Photographs  
1000 Foot Radius/MCD Proximity Map  
Context Photographs  
Site Photographs  
Reduced Architectural Plans

Elizabeth Watty  
San Francisco Planning Department  
1650 Mission Street, Suite 400  
San Francisco, CA 94103

April 3, 2012

Dear Ms. Watty:

I am writing to express the Office of Economic & Workforce Development's (OEWD) opposition to the permit for a medical cannabis dispensary at 471 Jessie Street. Our opposition is based on a number of reasons, summarized below.

Since 2010, OEWD has been coordinating the Central Market Partnership, a multi-agency, public-private initiative to stabilize and revitalize the Central Market district. Among its many objectives, this initiative aims to attract a variety of neighborhood-serving retail to fill vacancies in the district. Given that there are multiple existing medical cannabis dispensaries (MCDs) within the immediate area of the proposed project, the creation of an additional MCD would be counter to the economic development goals of the neighborhood.

In 2011, OEWD coordinated a 10-month community process, engaging a broad set of stakeholders with the goal of identifying and prioritizing the economic and community development strategies for Central Market. The resulting document, the Central Market Economic Strategy, recommends limiting the expansion of medical cannabis dispensaries in the neighborhood. Given the public process that contributed to the creation of this document, which included multiple rounds of iteration, we believe that a significant majority of community stakeholders (residents, merchants, property owners, employers, nonprofit organizations, arts and cultural institutions, etc) feel that the creation of an additional MCD would be detrimental to the neighborhood.

I urge the members of the Planning Commission to reject the permit application for this project. If you have further questions, please contact me at (415) 554-6645.

Regards,



Jordan Klein  
Project Manager, Neighborhood Economic Development



**From:** [DANIEL HURTADO](#)  
**To:** [elizabeth.watty@sfgov.org](mailto:elizabeth.watty@sfgov.org)  
**Subject:** 471 Jessie Street  
**Date:** 03/19/2012 05:35 PM

---

Dear Elizabeth Watty:

The Central Market Community Benefit District (CMCBD) is a non-profit, 501 (c)(3) community-based organization that provides services and programs designed to improve the quality of life in the public realm of San Francisco's Central Market district and to create a cleaner, safer and more welcoming environment for the residents, merchants, visitors, patrons and property owners of the neighborhood.

As the Executive Director of the CMCBD, I am writing to express my concern regarding a medical marijuana dispensary's application for a building permit at 471 Jessie Street in the Central Market district. As you may be aware, plans have already been approved for a medical marijuana dispensary – Grass Roots – to locate on the opposite side of the same block at 952 Mission Street, just around the corner from this proposed location. Furthermore, there are other medical marijuana dispensaries near this proposed location that already serve this area, including The Green Door at 843 Howard Street, HopeNet at 223 Ninth Street, and ReLeaf Herbal Center at 1284 Mission Street.

One of the objectives of the Central Market Economic Strategy issued by Mayor Edward M. Lee is to improve safety and enhance the quality of life and desirability of Central Market for residents, workers, shoppers and visitors. In doing so, the Central Market Economic Strategy also seeks to implement land use controls such as conditional use permits to ensure adequate review of new 'nuisance' retail and entertainment, including liquor stores, adult uses, pawn shops and medical cannabis dispensaries to ensure balance of uses in the district. The Central Market Economic Strategy and its objectives were created by and for the Central Market community, with input from the district's residents, merchants, property owners, neighborhood leaders and community-based organizations that serve this neighborhood.

Under the guiding principles of the Central Market Economic Strategy, the Central Market community seeks to promote the development of a healthy, economically functional neighborhood that is clean, safe and provides access to quality and affordable goods and services. By limiting the quantity of medical marijuana dispensaries in and around Central Market, opportunities will be more available for other storefront uses that are positive, community-serving businesses that meet the needs of the neighborhood and provide products and services for the majority of the residents, workers and patrons of Central Market.

As a member of the Central Market district, a neighborhood stakeholder and representative, and the Executive Director of the CMCBD, I urge you and the San Francisco Planning Department to reconsider the permit application submitted by the medical marijuana dispensary for 471 Jessie Street and to consider the negative impact this will have in the improvement and revitalization of Central Market.

Thank you.

-----  
Daniel Hurtado  
Executive Director  
Central Market Community Benefit District  
Office: 415.957.5985 - Cell: 415.533.5531  
[www.Central-Market.org](http://www.Central-Market.org)

**Join us on Facebook:** [www.facebook.com/CentralMarketSF](http://www.facebook.com/CentralMarketSF)

**Follow us on Twitter:** [www.twitter.com/CentralMarketSF](http://www.twitter.com/CentralMarketSF)

**From:** [snelson1640@aol.com](mailto:snelson1640@aol.com)  
**To:** [elizabeth.watty@sfgov.org](mailto:elizabeth.watty@sfgov.org)  
**Subject:** Central Market Permit Application  
**Date:** 03/21/2012 04:53 PM

---

Hello Ms Watty,  
I reside on Howard Street (between 8th & 9th Streets) and am actively involved with two volunteer community groups. I am deeply concerned about the application for building permit for a medical marijuana dispensary at 471 Jessie Street. Considering there is already a medical marijuana dispensary approved for 952 Mission Street, there is no need for a second dispensary literally around the corner. This hardly supports the vision put forth by City Hall and local community groups for the future rejuvenation of the Central Market Corridor. I am opposed to this permit because I think it will deter the positive growth proposed by the city and residents.  
Sincerely,  
SuSan Nelson

**From:** [Goldsmith, Ronnyjane](mailto:Goldsmith.Ronnyjane)  
**To:** [elizabeth.watty@sfgov.org](mailto:elizabeth.watty@sfgov.org)  
**Subject:** central market permit application  
**Date:** 03/20/2012 09:44 AM

---

Dear Elizabeth Watty:

I am writing to express my concern regarding a medical marijuana dispensary's application for a building permit at 471 Jessie Street in the Central Market district.

As you are aware, plans have been approved for a medical marijuana dispensary - Grass Roots - to locate on the opposite side of the same block at 952 Mission Street, just around the corner from this proposed location. In addition, there are other medical marijuana dispensaries near the proposed location that already serve this area, including The Green Door at 843 Howard Street, HopeNet at 223 Ninth Street, and ReLeaf Herbal Center at 1284 Mission Street.

One of the objectives of the Central Market Economic Strategy issued by Mayor Edward M. Lee is to improve safety and enhance the quality of life and desirability of Central Market for residents, workers, shoppers and visitors. The Central Market Economic Strategy seeks to implement land use controls such as conditional use permits to ensure adequate review of new 'nuisance' retail and entertainment, including medical cannabis dispensaries to ensure balance of uses in the district. By limiting the number of medical marijuana dispensaries in and around Central Market, opportunities will be more available for other storefront uses that are positive, community-serving businesses that meet the needs of the neighborhood and provide products and services for the majority of the residents, workers and patrons of Central Market.

As a neighborhood stakeholder and one of the founders of Howard Street Clean and Green NA, I urge you and the San Francisco Planning Department to reconsider and deny the permit application submitted by the medical marijuana dispensary for 471 Jessie Street in consideration of the negative impact this will have in the improvement and revitalization of Central Market.

-----  
Important Notice to Recipients:

Please do not use e-mail to request, authorize or effect the purchase or sale of any security or commodity. Unfortunately, we cannot execute such instructions provided in e-mail. Thank you.

The sender of this e-mail is an employee of Morgan Stanley Smith Barney LLC. If you have received this communication in error, please destroy all electronic and paper copies and notify the sender immediately. Erroneous transmission is not intended to waive confidentiality or privilege. Morgan Stanley Smith Barney reserves the right, to the extent permitted under applicable law, to monitor electronic communications. This message is subject to terms available at the following link: <http://www.morganstanley.com/disclaimers/mssbemail.html>. If you cannot access this link, please notify us by reply message and we will send the contents to you. By messaging with Morgan Stanley Smith Barney you consent to the foregoing.



**From:** [Jane Weil](#)  
**To:** [elizabeth.watty@sfgov.org](mailto:elizabeth.watty@sfgov.org)  
**Subject:** opposition to medical marijuana dispensary filing for building permit at 471 Jessie Street  
**Date:** 03/20/2012 12:33 AM

---

Dear Ms. Watty,

I am writing to express my disapproval of the permit for a medical marijuana dispensary proposed for 471 Jessie Street. Our immediate neighborhood already has at least four other pot clubs, plus at least one methadone clinic, so there is no need for another to service those with legitimate needs.

Many of us have been working very hard to improve the quality of life in our neighborhood, and we are having lots of successes. Our part of Mid Market is becoming a healthier, cleaner place to live, safer and with more quality goods and services. There is still a lot more to do. By limiting the number of marijuana dispensaries there will be more room for the other small businesses that we need.

As a resident of Mission Street, between 7<sup>th</sup> & 8<sup>th</sup>, I plead with you and the Planning Commission to reject the permit application for a Pot Club for 471 Jessie St, considering that there are already four so many others within a small area. Such a concentration does not serve the residents here, but rather, brings in outsiders that do nothing to enhance our quality of life.

Thank you for your consideration,

Jane Weil

1160 Mission St #2108

San Francisco CA 94103

415-409-6396

CASE NUMBER:  
 For Staff Use only

2011.1058D

# APPLICATION TO OPERATE A Medical Cannabis Dispensary

## 1. Owner/Applicant Information

PROPERTY OWNER'S NAME: Jessie Street LLC, Grant Leong Owner Manager	
PROPERTY OWNER'S ADDRESS:	TELEPHONE: ( 415 ) 272-7876
	EMAIL:

APPLICANT'S NAME: Daniel Bornstein <span style="float: right;">Same as Above <input type="checkbox"/></span>	
APPLICANT'S ADDRESS: 507 Polk Street, Suite 320 San Francisco CA 94102	TELEPHONE: (415 ) 409.7611
	EMAIL: daniel@bornsteinandbornstein.com

CONTACT FOR PROJECT INFORMATION: additional contact: Troy Kshanipour <span style="float: right;">Same as Above <input checked="" type="checkbox"/></span>	
ADDRESS: 2325 3rd Street Suite 401 San Francisco, CA 94107	TELEPHONE: (415 ) 431.0869
	EMAIL: tk@tkworkshop.com

## 2. Location and Dispensary Information

STREET ADDRESS OF PROJECT: 471 Jessie Street	ZIP CODE: 94103
CROSS STREETS: Mint Street / 6th Street	

ASSESSORS BLOCK/LOT: 3704 / 028	ZONING DISTRICT: C-G-3
------------------------------------	---------------------------

DISPENSARY SQ FT: 1340	SQ FT. ACCESSIBLE TO PATRONS: 782	FLOOR ON WHICH DISPENSARY IS LOCATED:. 1ST
---------------------------	--------------------------------------	---

PROPOSED BUSINESS NAME (IF KNOWN): J.M. Collective
PRESENT OR PREVIOUS USE: Garment Manufacturer, Warehouse currently unoccupied

### 3. Dispensary Proximity

<b>PROXIMITY TO SCHOOLS</b>	( Initial Below )
I have used all reasonable resources available to me, including maps and zoning information made available by the Planning Department and a personal and thorough inspection of the broader vicinity of the subject property and have found that, to the best of my knowledge, the property is not within 1,000 feet of an elementary or secondary school, public or private.	TK
<b>PROXIMITY TO RECREATION BUILDINGS</b>	( Initial Below )
I have used all reasonable resources available to me, including maps and zoning information made available by the Planning Department and a personal and thorough inspection of the broader vicinity of the subject property and have found that, to the best of my knowledge, the property is not within 1,000 feet of a recreation building, as defined in the Planning Code.	TK
<b>PROXIMITY TO SUBSTANCE ABUSE TREATMENT FACILITIES</b>	( Initial Below )
I have used all reasonable resources available to me, including a personal inspection of the subject property and have found that, to the best of my knowledge, the property does not contain a substance abuse treatment facility.	TK

### 4. Dispensary Services

<b>ON SITE SMOKING</b>	
Will you allow patrons or employees to smoke or vaporize medical cannabis on the premises?	<input type="checkbox"/> YES <input checked="" type="checkbox"/> NO
<b>CANNABIS FOODSTUFFS</b>	
Will you offer medical cannabis in the form of food or drink? ( Note that if foodstuffs are provided additional permits will be required from the Department of Public Health )	<input type="checkbox"/> YES <input checked="" type="checkbox"/> NO
<b>CANNABIS GROWING</b>	
Will any live marijuana plants be kept on the premises for purposes of harvesting medical product? If so, please declare the proposed square footage to be dedicated to growing activities. ( Note that additional mechanical systems may be required and that Planning Code standards for accessory uses may preclude the dedication of more than 1/4 of the total floor area of the dispensary for such use )	<input type="checkbox"/> YES <input checked="" type="checkbox"/> NO  SQFT:

5. Applicant's Statement

Please discuss:

1. The business plan for the proposed Medical Cannabis Dispensary;

Please see attached document

---

---

---

---

---

---

---

---

---

---

---

---

---

---

---

---

---

---

---

---

---

---

---

---

2. Specific factors which contribute to the compatibility and appropriateness of the Medical Cannabis Dispensary with the immediate neighborhood and broader City environment;

JM Collective is particularly well-suited for this location within the immediate neighborhood as it offers easy pedestrian access to attract member/patients in a setting that will be both beautiful and user friendly in a quiet setting. By allowing for easy access to the facility, JM Collective will promote pedestrian traffic in a manner that will help contribute to the overall betterment of the street and the local environment. JM Collective will be enlarging the amount of pedestrian traffic in this vicinity. More business surrounding this area will be able to enjoy the potential benefit of customers.

In addition:

1. Our focus on quality of product, pleasant atmosphere, and friendly customer service pairs well with the attitudes and practices of the neighborhood's other businesses.
2. Our commitment to organic growth makes us compatible with local businesses that help makes the neighborhood distinct from areas that are oversaturated with large, corporate chain stores.
3. Making our vibrant membership culture a key part of our brand is one of our goals. This is congruent to values of celebrating local community, which has long been a hallmark of the Mission Street neighborhood.

3. Neighborhood outreach efforts made and the results/input from those efforts;

We have engaged in walking outreach efforts where we attempt to meet members of the community and alert them to our proposals. We have sent out invitations to community members to a pre-application meeting, where we introduced ourselves, our values, and answered any questions and concerns the community had. We continue to work with the landlord to ensure that those individual community members in close proximity to our collective are kept abreast of all of our plans and intended goals for the space.

We plan to continue the engagement of the community to another meeting during the application process.

We have received input as a result of our pre-application meeting. We will apply the comments made at the meeting to better address any/all concerns raised by the community. We have taken many ideas on how to maintain the vibrancy, safety, and cleanliness of the neighborhood.

4. Any other circumstances applying to the property involved which you feel support your application.

The physical structure of the proposed dispensary building is an ideal structure to house a collective. It provides ample space and a wonderful palette to develop a collective which contributes to the vitality of the community. We intend to provide our members with a location to both secure medicine and also be a respite for the admitted urban nature of Jessie Street. With quiet music and a gentle interior design, we will be elevating the shell of this building to a beautiful physical locale.

Focusing our strategy on quiet, organic growth of our collective will ensure that the neighborhood is not unduly tasked with having to integrate our dispensary into its day-to-day activities. Evolving in this way will help ensure balance within the neighborhood, ultimately leading to a cohesive and well respected presence on Jessie Street.

## Priority General Plan Policies Findings

Proposition M was adopted by the voters on November 4, 1986. It requires that the City shall find that proposed projects and demolitions are consistent with eight priority policies set forth in Section 101.1 of the City Planning Code. These eight policies are listed below. Please state how the project is consistent or inconsistent with each policy. Each statement should refer to specific circumstances or conditions applicable to the property. Each policy must have a response. IF A GIVEN POLICY DOES NOT APPLY TO YOUR PROJECT, EXPLAIN WHY IT DOES NOT.

1. That existing neighborhood-serving retail uses be preserved and enhanced and future opportunities for resident employment in and ownership of such businesses enhanced;

The proposed MCD takes a vacant commercial space and activates it with a new pedestrian oriented use. This enhances other neighborhood serving retail uses in the immediate area. Employee staffing will draw from all San Francisco neighborhoods providing opportunities for resident employment.

2. That existing housing and neighborhood character be conserved and protected in order to preserve the cultural and economic diversity of our neighborhoods;

The proposed MCD will be at the ground floor of a commercial space. There will be no displacement of housing. The MCD will be a quite, yet welcoming business that will help contribute to the overall betterment of the street and the local environment.

3. That the City's supply of affordable housing be preserved and enhanced;

The MCD will not displace affordable housing but will serve the medicinal needs of those in the immediate neighborhood.

4. That commuter traffic not impede Muni transit service or overburden our streets or neighborhood parking;

The MCD is a pedestrian oriented facility consistent with other businesses in the immediate area. Parking will not be provided, nor will travel by private vehicle to the MCD be encouraged.

5. That a diverse economic base be maintained by protecting our industrial and service sectors from displacement due to commercial office development, and that future opportunities for resident employment and ownership in these sectors be enhanced;

The MCD does not displace industrial or service sector uses through commercial office development. There is no commercial office component of the proposed MCD.

6. That the City achieve the greatest possible preparedness to protect against injury and loss of life in an earthquake;

The building will be provided with structural upgrades as appropriate for the new use. System upgrades will be undertaken which include provision of code appropriate exit passageways and signage to ensure appropriate lifesafety in the event of an earthquake or fire.

7. That landmarks and historic buildings be preserved; and

The MCD will not be constructed in a historically landmarked building. The use of the building will conserve the existing fabric of the original brick building. The MCD and Architect will work with the historic preservation planner to define appropriate improvements to conserve the character of the building.

8. That our parks and open space and their access to sunlight and vistas be protected from development.

The MCD will not diminish the sunlight or vistas of parks or open space.

## Applicant's Affidavit

Under penalty of perjury the following declarations are made:

- a: The undersigned is the owner or authorized agent of the owner of this property.
- b: The information presented is true and correct to the best of my knowledge.
- c: The other information or applications may be required.

Signature: Troy Kashanipour

Date: 10.03.11

Print name, and indicate whether owner, or authorized agent:

Troy Kashanipour

Owner  Authorized Agent  (circle one)

For Department Use Only

Application received by Planning Department:

By: Wally

Date: 10/6/11



**Business Plan:**

JM Collective's business execution plan focuses on organic growth of our membership with an accommodating landlord and collaboration with member cultivators to evolve a successful organization.

We will commence a small operation employing no more than five individual members and manage growth, revenues and expenses in a fiscally prudent manner. Our landlord is willing to defer rent obligations while we emerge as a strong organization. We will attract new members through social media strategies, traditional marketing in industry trade magazines and offering attractive donations for medicinal cannabis. Our goal is to evolve into a contributing member of the medicinal cannabis community by maintain an outstanding reputation for delivery of services to our collective members. We will ask our members to contribute volunteer time to assist in creating an organization that is cohesive, maintains its core values of service to its membership and a continued commitment to foster outstanding relations to the neighborhood.

The initial capital investment shall come from the organizers of the collective and will come with no expectation of immediate reimbursement. This will ensure that capitalization is proper, robust and without fear of stringent lending terms.

Execution of the above-referenced plan shall occur in the following chronology:

**Objective 1: Develop and Maintain Core Values and Best Patient Practices – Emphasis on cultivating outstanding medicine and establishing a cohesive membership community --**

**Action step 1: Draft mission statement and establish policies documented through the collective's bylaws;**

**Action step 2: Train/reinforce staff members to create a culture consistent with core values – training shall occur prior to the commencement of the facility's opening;**

**Objective 2: Secure stable and consistent operational finances**

**Action step 1: Manage startup capital and lease with landlord. Develop budget plan and manage expenses commensurate with expected financial commitments;**

**Action step 2: Develop strong collective recognition and prominence by continuing to reinvest capital earned into services offered the membership;**

**Objective 3: Promote organic growth through member loyalty, affinity and community outreach**

**Action step 1: Grow membership through customer satisfaction and word of mouth promotions.**

**Action step 2: Expand marketing by offering special rewards for member loyalty.**

**Action step 3: Market our core values through trade magazines, community outreach events, and other forums.**

**Action step 4: Market membership culture as part of our branding.**



# Sanborn Map

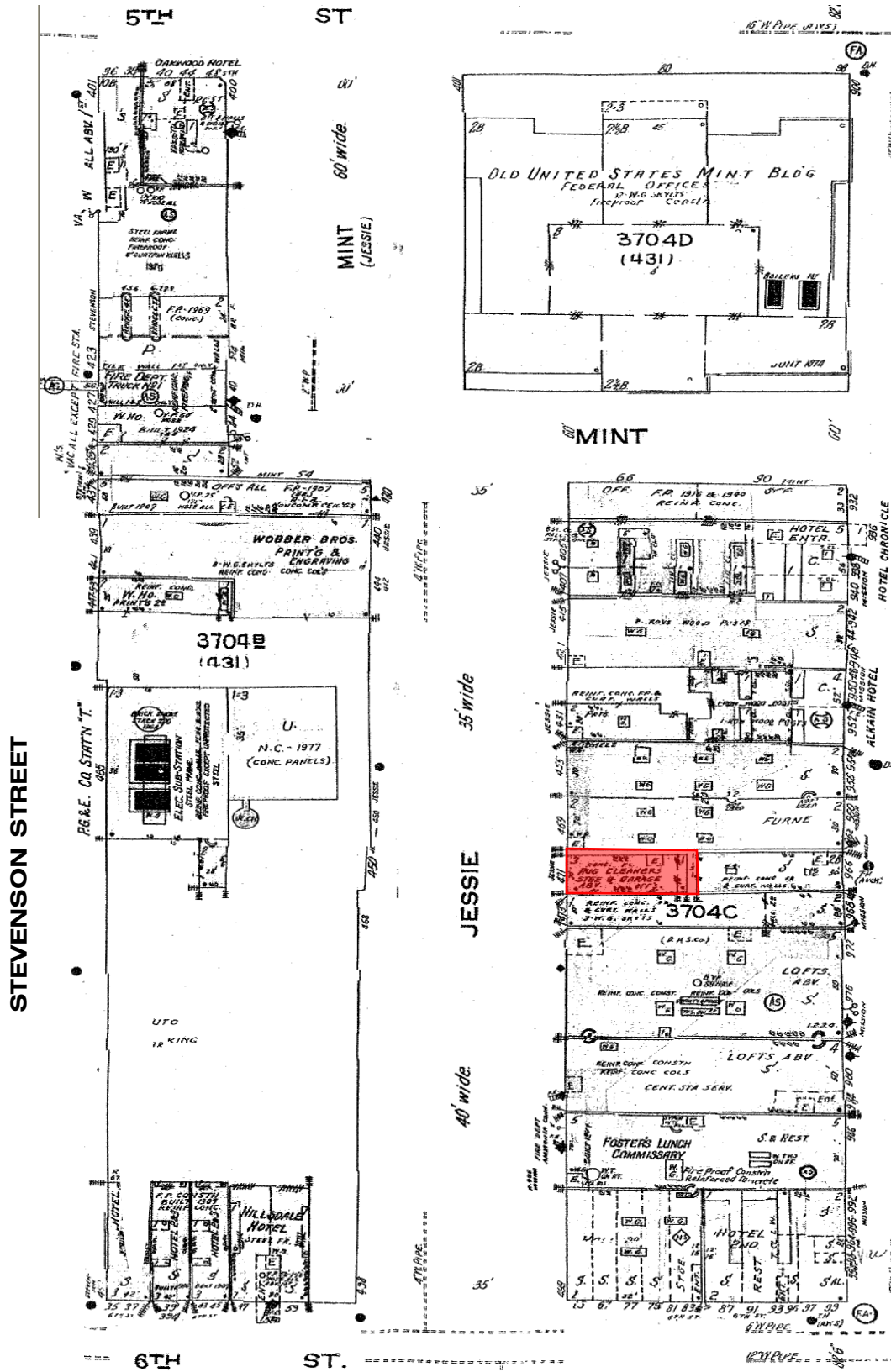

\*The Sanborn Maps in San Francisco have not been updated since 1998, and this map may not accurately reflect existing conditions.

SAN FRANCISCO  
PLANNING DEPARTMENT



MANDATORY DISCRETIONARY REVIEW  
MCD dba "JM Collective"  
Building Permit No. 2011.11.08.8514  
Case Number 2011.1058D  
471 Jessie Street

# Zoning Map

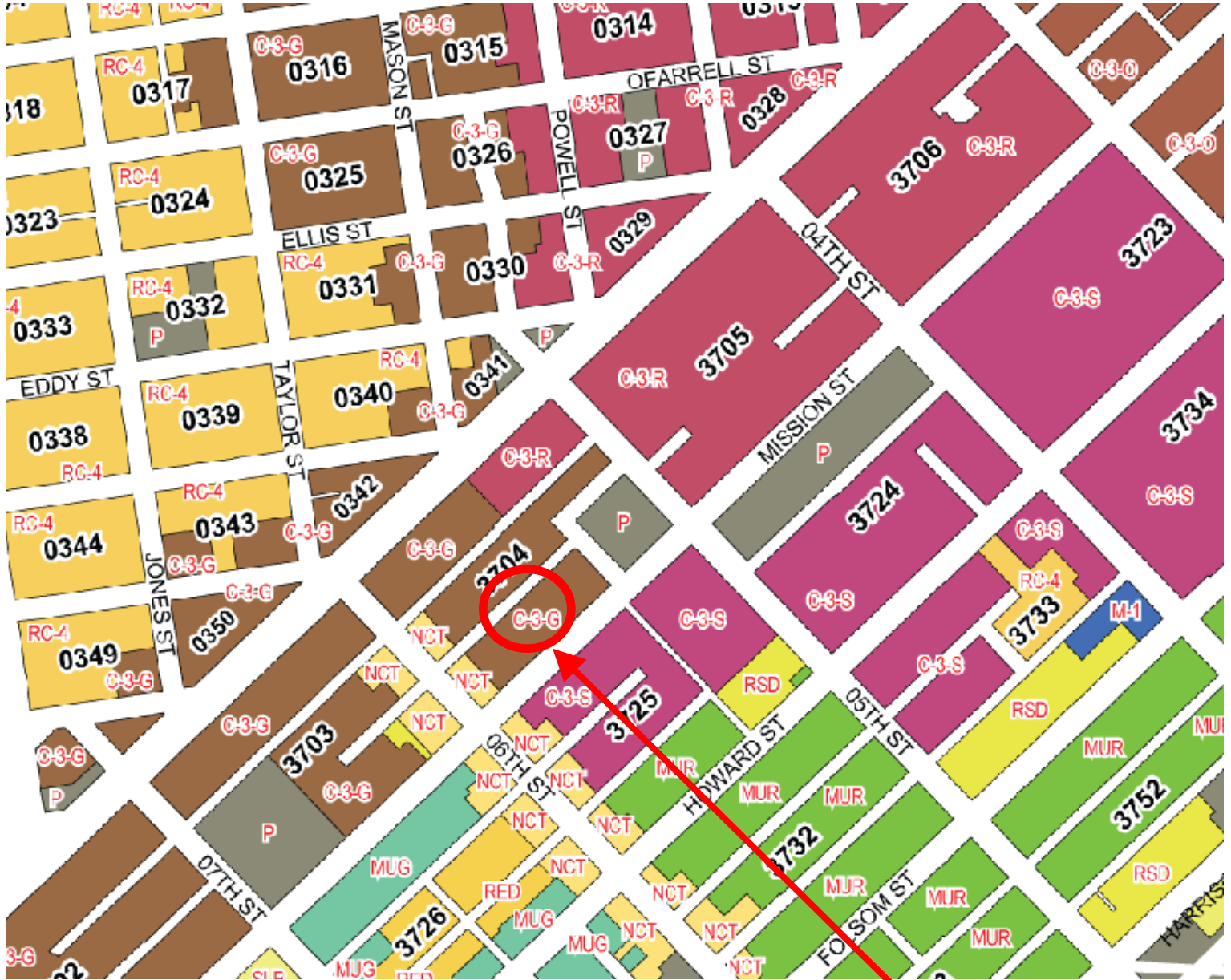

**SUBJECT PROPERTY**





# Aerial Photos



**SUBJECT PROPERTY**



MANDATORY DISCRETIONARY REVIEW  
MCD dba "JM Collective"  
**Building Permit No. 2011.11.08.8514**  
**Case Number 2011.1058D**  
471 Jessie Street



# Aerial Photos



**SUBJECT PROPERTY**



MANDATORY DISCRETIONARY REVIEW  
MCD dba "JM Collective"  
**Building Permit No. 2011.11.08.8514**  
**Case Number 2011.1058D**  
471 Jessie Street



# Aerial Photos



**SUBJECT PROPERTY**



MANDATORY DISCRETIONARY REVIEW  
MCD dba "JM Collective"  
**Building Permit No. 2011.11.08.8514**  
**Case Number 2011.1058D**  
471 Jessie Street



# Aerial Photos



**SUBJECT PROPERTY**

MANDATORY DISCRETIONARY REVIEW  
MCD dba "JM Collective"  
**Building Permit No. 2011.11.08.8514**  
**Case Number 2011.1058D**  
471 Jessie Street





# Aerial Photos



**SUBJECT PROPERTY**



MANDATORY DISCRETIONARY REVIEW  
MCD dba "JM Collective"  
**Building Permit No. 2011.11.08.8514**  
**Case Number 2011.1058D**  
471 Jessie Street



# MCD Map - 471 Jessie Street - 1000' boundary

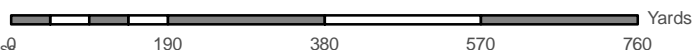
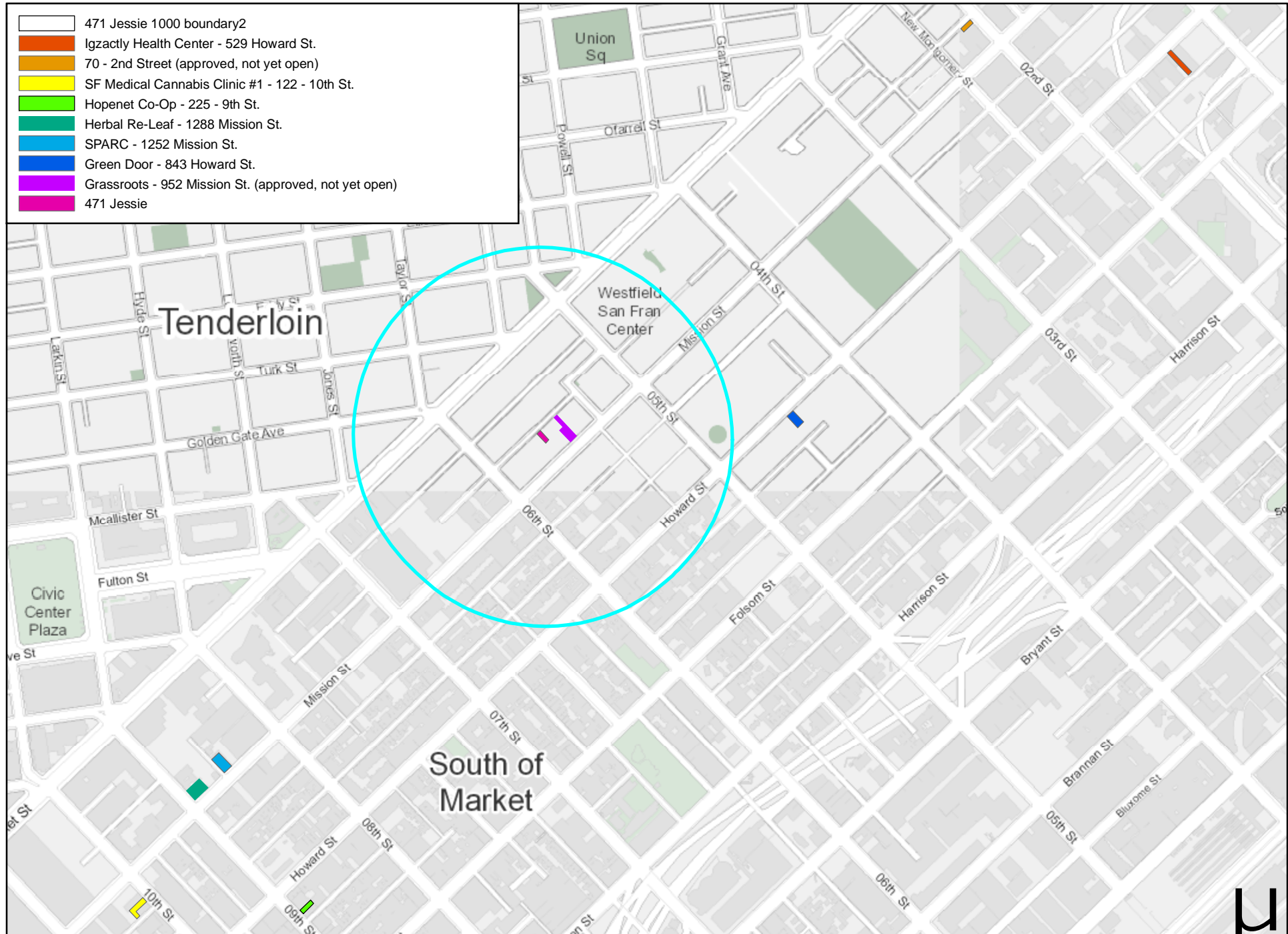

Printed: 30 March, 2012

The City and County of San Francisco (CCSF) does not guarantee the accuracy, adequacy, completeness or usefulness of any information. CCSF provides this information on an "as is" basis without warranty of any kind, including but not limited to warranties of merchantability or fitness for a particular purpose, and assumes no responsibility for anyone's use of the information.





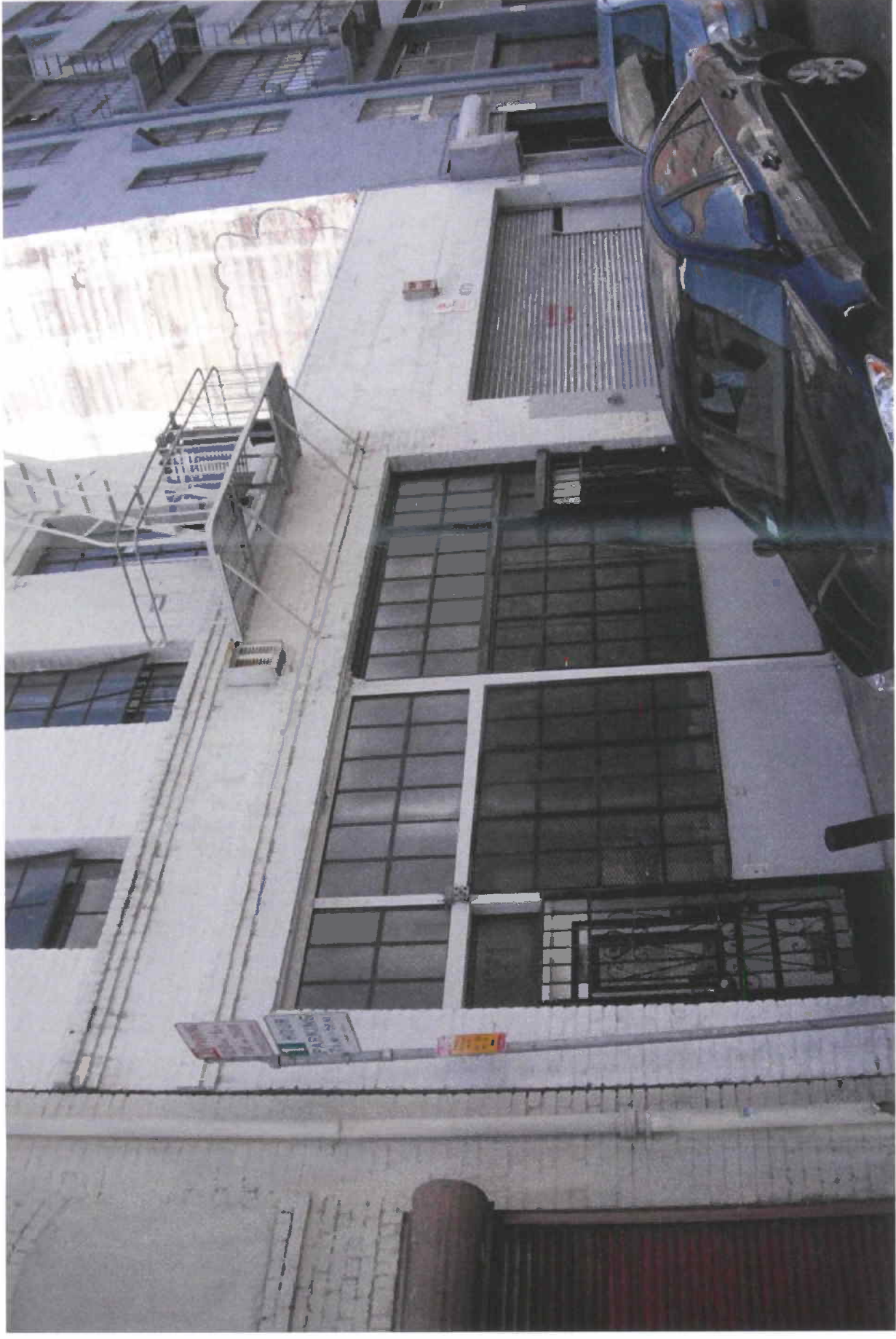

471 JESSIE EXISTING STOREFRONT

471 JESSIE







VIEW ACROSS STREET TO PG&E FACILITY





471 JESSIE

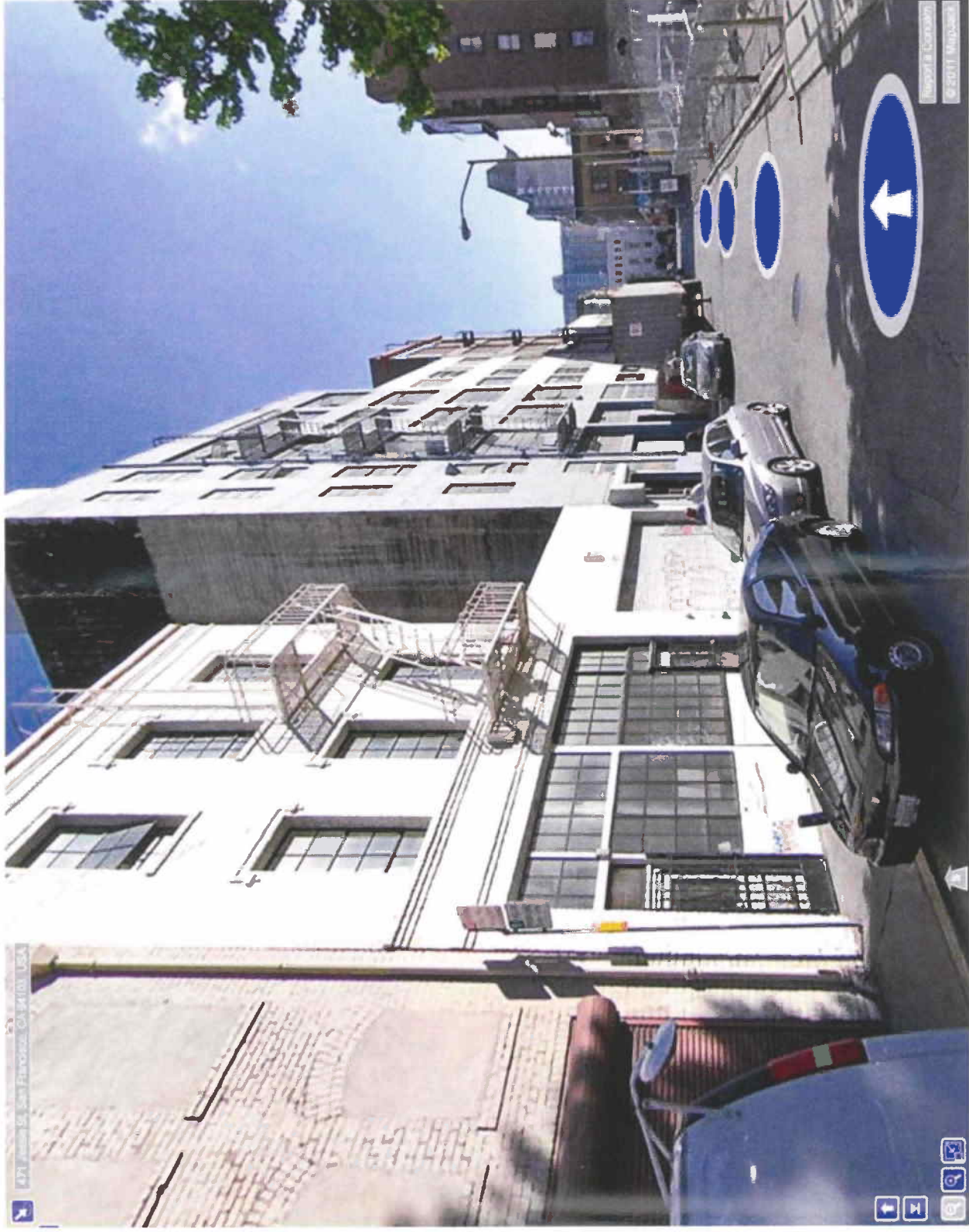

JESSIE STREET LOOKING WEST



JESSIE STREET LOOKING EAST



SHEET INDEX

- A00 PROJECT INFORMATION/ACCESS COMPLIANCE CHECKLISTS
A01 TITLE 24 ENERGY COMPLIANCE REPORT
A02 TITLE 24 ENERGY COMPLIANCE REPORT
A03 TITLE 24 ENERGY COMPLIANCE REPORT
A04 TITLE 24 ENERGY COMPLIANCE REPORT
A05 EXISTING FLOOR PLANS, ELEVATIONS, BUILDING SECTION
A06 PROPOSED REFLECTED CEILING PLAN

SCOPE OF WORK THIS PROJECT:

TENANT IMPROVEMENT FOR NEW MEDICAL CANABIS DISPENSARY
-INTERIOR PARTITION WALLS IN WAITING AREA, PATIENT AREA,
-RESTROOMS AT JESSIE STREET.

REGULATIONS & STANDARDS:

- ADAGC AMENDMENTS WITH DISABILITIES ACT ACCESSIBILITY GUIDELINES
-2010 CALIFORNIA PLUMBING CODE WITH SAN FRANCISCO AMENDMENTS.
-2010 CALIFORNIA ELECTRICAL CODE WITH SAN FRANCISCO AMENDMENTS.
-2010 CALIFORNIA FIRE CODE WITH SAN FRANCISCO AMENDMENTS.
-ENERGY CODE - TITLE 24 - CALIFORNIA CODE OF REGULATIONS
-LIFE SAFETY CODE - 2007 EDITION NFPA 72
-2010 CALIFORNIA FIRE CODE WITH SAN FRANCISCO AMENDMENTS.
-2010 CALIFORNIA PLUMBING CODE WITH SAN FRANCISCO AMENDMENTS.
-2010 CALIFORNIA ELECTRICAL CODE WITH SAN FRANCISCO AMENDMENTS.
-2010 CALIFORNIA FIRE CODE WITH SAN FRANCISCO AMENDMENTS.
-ENERGY CODE - TITLE 24 - CALIFORNIA CODE OF REGULATIONS
-LIFE SAFETY CODE - 2007 EDITION NFPA 72
-2010 CALIFORNIA FIRE CODE WITH SAN FRANCISCO AMENDMENTS.

BUILDING & PLANNING DEPT. NOTES:

FIRST FLOOR TENANT: JM COLLECTIVE COO DANIEL DORNSHEIN 100 SAN FRANCISCO, CA 94102 PHONE: (415) 437-9113 DANIEL@DORNSHEINARCHITECTURE.COM
ARCHITECT: TROY KASHANPOUR ARCHITECTURE 100 SAN FRANCISCO, CA 94102 PHONE: (415) 437-9113 TROY@TKASHANPOUR.COM
BLOCKLOT: BLOCK 3704 LOT 028
ZONING: C-40 DOWNTOWN GENERAL
USE: MEDICAL CANABIS DISPENSARY, 2ND-FLOOR FLOOR RESIDENTIAL
OCCUPANCY: 6 154-10 (RESIDENTIAL UNITS)
NUMBER OF STORIES: 3
AREA OF IMPROVEMENT: 1,340 SQUARE FEET
EXISTING CONSTRUCTION TYPE: ?
PROPOSED FOR TL1, V47
TYPE OF CONSTRUCTION: SEE ADA/FOR SUMMARY
ENTING: SEE ADA CHECKLIST AND SHEET A20
ACCESSIBILITY: BUILDING IS NOT EQUIPPED WITH AUTOMATIC FIRE SPRINKLER SYSTEM, NONE WILL BE PROVIDED UNDER THIS PERMIT APPLICATION

LOCATION PLAN

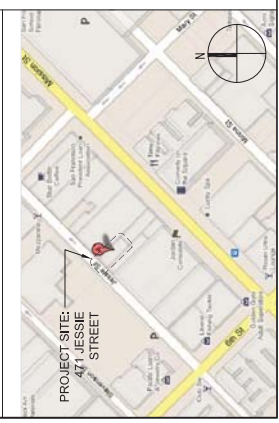

ACCESSIBILITY CHECKLISTS

DA CHECKLIST (p. 1 of 2): The address of the project is 471 JESSIE STREET. The proposed use of the project is MEDICAL CANABIS DISPENSARY (MCD). The address of the project is 471 JESSIE STREET. The proposed use of the project is MEDICAL CANABIS DISPENSARY (MCD). The address of the project is 471 JESSIE STREET. The proposed use of the project is MEDICAL CANABIS DISPENSARY (MCD).

DA CHECKLIST (p. 2 of 2)

Table with columns for ADA Checklist items (1-18) and checkboxes for compliance. Includes a 'TOTAL' row at the bottom.

Mayor's Office on Disability DISABILITY ACCESS COMPLIANCE APPROVAL

Form for Disability Access Compliance Approval. Includes fields for project name, address, and project number. Includes a section for 'Project Information' and 'Project Schedule'.

Mayor's Office on Disability Project Intake

Project Name: JM Collective. MCD Project Number: 2011. Contact Information: Project Manager Name: Troy Kashanpour, Phone: (415) 437-9113, Email: tkashanpour@jmcoll.com.

Project Description: Tenant improvement for Medical Cannabis Dispensary. Project Funding: \$0.000. Project City: San Francisco. Project State: CA. Project City: San Francisco. Project State: CA.

UNREASONABLE HARDSHIP REQUEST

Form for Unreasonable Hardship Request. Includes fields for project name, address, and project number. Includes a section for 'Project Information' and 'Project Schedule'.

PROJECT INFORMATION ACCESS COMPLIANCE

Form for Project Information Access Compliance. Includes fields for project name, address, and project number. Includes a section for 'Project Information' and 'Project Schedule'.

UNREASONABLE HARDSHIP REQUEST (continued). Includes fields for project name, address, and project number. Includes a section for 'Project Information' and 'Project Schedule'.

UNREASONABLE HARDSHIP REQUEST (continued). Includes fields for project name, address, and project number. Includes a section for 'Project Information' and 'Project Schedule'.

PROJECT INFORMATION ACCESS COMPLIANCE (continued). Includes fields for project name, address, and project number. Includes a section for 'Project Information' and 'Project Schedule'.

471 JESSIE STREET TROY KASHANPOUR ARCHITECTURE 3205 STREET SUITE 413 SF CA 94107 PHONE: (415) 437-9113

CLIENT: JM COLLECTIVE C/O DANIEL DORNSHEIN 100 SAN FRANCISCO, CA 94102 PHONE: (415) 437-9113 DANIEL@DORNSHEINARCHITECTURE.COM

DATE: 07/27/11 ISSUED FOR PERMIT APPROVAL

A0.0

TROY KASHANIPOUR ARCHITECTURE 2325 3RD STREET SUITE 413, SF CA 94107, PH:415.431.0899

CLIENT: J.M. COLLECTIVE C/O 507 Park Street, Suite 320 San Francisco, CA 94102 Phone: 415.431.0899

DATE: 07/20/11 ISSUED FOR PERMIT

CONSULTANT:

APPROVAL: J.M. COLLECTIVE (Seal) DATE: 07/20/11

TITLE 24 ENERGY CALCULATIONS

A0.1

PERFORMANCE CERTIFICATE OF COMPLIANCE (Part 1 of 3) - PERFORMING PRODUCT (COOL ROOFS) - Includes table for roof area, materials, and compliance status.

PERFORMANCE CERTIFICATE OF COMPLIANCE (Part 2 of 3) - GENERAL INFORMATION - Includes project name, address, and contact details.

PERFORMANCE CERTIFICATE OF COMPLIANCE (Part 3 of 3) - FIELD INSPECTION ENERGY CHECKLIST - Includes checklist for various energy systems and components.

PERFORMANCE CERTIFICATE OF COMPLIANCE (Part 1 of 3) - FIELD INSPECTION ENERGY CHECKLIST - Includes checklist for various energy systems and components.

PERFORMANCE CERTIFICATE OF COMPLIANCE (Part 2 of 3) - FIELD INSPECTION ENERGY CHECKLIST - Includes checklist for various energy systems and components.

PERFORMANCE CERTIFICATE OF COMPLIANCE (Part 2 of 3) - BUILDING COMPLEXES - Includes energy use summary table and building complex details.



**CERTIFICATE OF COMPLIANCE (Part 1 of 3) LTG-1C** Date: 03/20/11

**CLIENT:** J.M. COLLECTIVE C/O  
 507 Park Street, Suite 300  
 San Francisco, CA 94102  
 Phone: 415.451.0899

**ISSUE:** ISSUED FOR PERMIT DATE: 03/20/11

**PROJECT:** 471 JESSIE STREET

**DESCRIPTION:** [Blank]

**DESIGNER:** J.M. COLLECTIVE

**REVISIONS:** [Blank]

**FIELD INSPECTOR'S NOTES:** [Blank]

**FIELD INSPECTOR'S SIGNATURE:** [Blank]

**DATE:** [Blank]

**CERTIFICATE OF COMPLIANCE (Part 2 of 3) LTG-1C** Date: 03/20/11

**CLIENT:** J.M. COLLECTIVE C/O  
 507 Park Street, Suite 300  
 San Francisco, CA 94102  
 Phone: 415.451.0899

**ISSUE:** ISSUED FOR PERMIT DATE: 03/20/11

**PROJECT:** 471 JESSIE STREET

**DESCRIPTION:** [Blank]

**DESIGNER:** J.M. COLLECTIVE

**REVISIONS:** [Blank]

**FIELD INSPECTOR'S NOTES:** [Blank]

**FIELD INSPECTOR'S SIGNATURE:** [Blank]

**DATE:** [Blank]

**CERTIFICATE OF COMPLIANCE and FIELD INSPECTION ENERGY CHECKLIST (Part 3 of 4) MECH-1C** Date: 03/20/11

**CLIENT:** J.M. COLLECTIVE C/O  
 507 Park Street, Suite 300  
 San Francisco, CA 94102  
 Phone: 415.451.0899

**ISSUE:** ISSUED FOR PERMIT DATE: 03/20/11

**PROJECT:** 471 JESSIE STREET

**DESCRIPTION:** [Blank]

**DESIGNER:** J.M. COLLECTIVE

**REVISIONS:** [Blank]

**FIELD INSPECTOR'S NOTES:** [Blank]

**FIELD INSPECTOR'S SIGNATURE:** [Blank]

**DATE:** [Blank]

**CERTIFICATE OF COMPLIANCE (Part 2 of 3) LTG-1C** Date: 03/20/11

**CLIENT:** J.M. COLLECTIVE C/O  
 507 Park Street, Suite 300  
 San Francisco, CA 94102  
 Phone: 415.451.0899

**ISSUE:** ISSUED FOR PERMIT DATE: 03/20/11

**PROJECT:** 471 JESSIE STREET

**DESCRIPTION:** [Blank]

**DESIGNER:** J.M. COLLECTIVE

**REVISIONS:** [Blank]

**FIELD INSPECTOR'S NOTES:** [Blank]

**FIELD INSPECTOR'S SIGNATURE:** [Blank]

**DATE:** [Blank]

**CERTIFICATE OF COMPLIANCE and FIELD INSPECTION ENERGY CHECKLIST (Part 3 of 4) MECH-1C** Date: 03/20/11

**CLIENT:** J.M. COLLECTIVE C/O  
 507 Park Street, Suite 300  
 San Francisco, CA 94102  
 Phone: 415.451.0899

**ISSUE:** ISSUED FOR PERMIT DATE: 03/20/11

**PROJECT:** 471 JESSIE STREET

**DESCRIPTION:** [Blank]

**DESIGNER:** J.M. COLLECTIVE

**REVISIONS:** [Blank]

**FIELD INSPECTOR'S NOTES:** [Blank]

**FIELD INSPECTOR'S SIGNATURE:** [Blank]

**DATE:** [Blank]

**CERTIFICATE OF COMPLIANCE and FIELD INSPECTION ENERGY CHECKLIST (Part 3 of 4) MECH-1C** Date: 03/20/11

**CLIENT:** J.M. COLLECTIVE C/O  
 507 Park Street, Suite 300  
 San Francisco, CA 94102  
 Phone: 415.451.0899

**ISSUE:** ISSUED FOR PERMIT DATE: 03/20/11

**PROJECT:** 471 JESSIE STREET

**DESCRIPTION:** [Blank]

**DESIGNER:** J.M. COLLECTIVE

**REVISIONS:** [Blank]

**FIELD INSPECTOR'S NOTES:** [Blank]

**FIELD INSPECTOR'S SIGNATURE:** [Blank]

**DATE:** [Blank]

TITLE 24 ENERGY CALCULATIONS

A0.2

TITLE 24 ENERGY CALCULATIONS

A0.2

TITLE 24 ENERGY CALCULATIONS

A0.2

TROY KASHANI POUR ARCHITECTURE 2325 360 STREET SUITE 413, CA 94107, PHONK/415.431.0899

CLIENT: J.M. COLLECTIVE C/O ...

ISSUE: ISSUED FOR PERMIT DATE: 07/20/11

CONSULTANT: APPROVAL:

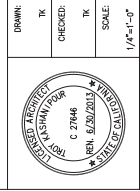

TITLE 24 ENERGY CALCULATIONS

A0.3

Mech-2C AIR SYSTEM REQUIREMENTS (Part 1 of 2) Table with columns for equipment name, type, quantity, and notes.

Mech-2C WATER SIDE SYSTEM REQUIREMENTS (Part 2 of 2) Table with columns for equipment name, type, quantity, and notes.

Mech-1C CERTIFICATE OF COMPLIANCE and FIELD INSPECTION ENERGY CHECKLIST (Part 4 of 4) Table for tracking energy conservation measures.

LTG-2C LIGHTING CONTROLS CREDIT WORKSHEET (Part 1 of 2) Table for tracking lighting controls credits.

Mech-3C MECHANICAL VENTILATION AND REHEAT Table with columns for equipment name, type, quantity, and notes.

Mech-3C MECHANICAL EQUIPMENT DETAILS Table with columns for equipment name, type, quantity, and notes.

CLIENT: J.M. COLLECTIVE C/O  
2070 Park Street, Suite 300  
San Francisco, CA 94102  
Phone: (415) 775-0200  
Email: jmc@jmccollective.com

DATE: 07/01/11  
ISSUE: ISSUED FOR PERMIT

ISSUE: ISSUED FOR PERMIT

CONSTRUCTION:

APPROVAL:

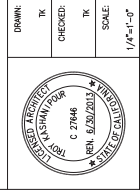

TITLE 24  
ENERGY CALCULATIONS  
  
A0.4

MECHANICAL MANDATORY MEASURES: NON-RESIDENTIAL	MECH-MM
Project Name: J.M. COLLECTIVE	07/01/2011
Site: 471 Jessie Street, SF, CA	07/01/2011
Client: J.M. Colletive	07/01/2011
Permit Number: 2011-07-00000-001	07/01/2011
Issue Date: 07/01/2011	07/01/2011
Issue: ISSUED FOR PERMIT	07/01/2011
Scale: 1/4"=1'-0"	1/4"=1'-0"
Sheet: MECH-MM-01	Page 27 of 27
<p><b>Building Envelope Measures:</b></p> <ul style="list-style-type: none"> <li>1116(1): Insulation for exterior walls shall be installed in accordance with the manufacturer's specifications to comply with the California Energy Code, Section 1116(2).</li> <li>1116(2): Insulation for exterior walls shall be installed in accordance with the California Energy Code, Section 1116(3).</li> <li>1116(3): Insulation for exterior walls shall be installed in accordance with the California Energy Code, Section 1116(4).</li> <li>1116(4): Insulation for exterior walls shall be installed in accordance with the California Energy Code, Section 1116(5).</li> </ul> <p><b>Controls</b></p> <ul style="list-style-type: none"> <li>1119(1): All programmable thermostats shall be installed in accordance with the California Energy Code, Section 1119(2).</li> <li>1119(2): All programmable thermostats shall be installed in accordance with the California Energy Code, Section 1119(3).</li> <li>1119(3): All programmable thermostats shall be installed in accordance with the California Energy Code, Section 1119(4).</li> <li>1119(4): All programmable thermostats shall be installed in accordance with the California Energy Code, Section 1119(5).</li> </ul>	

ENVELOPE MANDATORY MEASURES: NON-RESIDENTIAL	ENV-MM
Project Name: J.M. COLLECTIVE	07/01/2011
Site: 471 Jessie Street, SF, CA	07/01/2011
Client: J.M. Colletive	07/01/2011
Permit Number: 2011-07-00000-001	07/01/2011
Issue Date: 07/01/2011	07/01/2011
Issue: ISSUED FOR PERMIT	07/01/2011
Scale: 1/4"=1'-0"	1/4"=1'-0"
Sheet: ENV-MM-01	Page 27 of 27
<p><b>Building Envelope Measures:</b></p> <ul style="list-style-type: none"> <li>1116(1): Insulation for exterior walls shall be installed in accordance with the manufacturer's specifications to comply with the California Energy Code, Section 1116(2).</li> <li>1116(2): Insulation for exterior walls shall be installed in accordance with the California Energy Code, Section 1116(3).</li> <li>1116(3): Insulation for exterior walls shall be installed in accordance with the California Energy Code, Section 1116(4).</li> <li>1116(4): Insulation for exterior walls shall be installed in accordance with the California Energy Code, Section 1116(5).</li> <li>1116(5): Insulation for exterior walls shall be installed in accordance with the California Energy Code, Section 1116(6).</li> </ul>	

LIGHTING MANDATORY MEASURES: NON-RESIDENTIAL	LTO-MM
Project Name: J.M. COLLECTIVE	07/01/2011
Site: 471 Jessie Street, SF, CA	07/01/2011
Client: J.M. Colletive	07/01/2011
Permit Number: 2011-07-00000-001	07/01/2011
Issue Date: 07/01/2011	07/01/2011
Issue: ISSUED FOR PERMIT	07/01/2011
Scale: 1/4"=1'-0"	1/4"=1'-0"
Sheet: LTO-MM-01	Page 27 of 27
<p><b>Lighting Measures:</b></p> <ul style="list-style-type: none"> <li>1116(1): All lighting fixtures shall be installed in accordance with the manufacturer's specifications to comply with the California Energy Code, Section 1116(2).</li> <li>1116(2): All lighting fixtures shall be installed in accordance with the California Energy Code, Section 1116(3).</li> <li>1116(3): All lighting fixtures shall be installed in accordance with the California Energy Code, Section 1116(4).</li> <li>1116(4): All lighting fixtures shall be installed in accordance with the California Energy Code, Section 1116(5).</li> <li>1116(5): All lighting fixtures shall be installed in accordance with the California Energy Code, Section 1116(6).</li> </ul>	

MECHANICAL MANDATORY MEASURES: NON-RESIDENTIAL	MECH-MM
Project Name: J.M. COLLECTIVE	07/01/2011
Site: 471 Jessie Street, SF, CA	07/01/2011
Client: J.M. Colletive	07/01/2011
Permit Number: 2011-07-00000-001	07/01/2011
Issue Date: 07/01/2011	07/01/2011
Issue: ISSUED FOR PERMIT	07/01/2011
Scale: 1/4"=1'-0"	1/4"=1'-0"
Sheet: MECH-MM-01	Page 27 of 27
<p><b>Building Envelope Measures:</b></p> <ul style="list-style-type: none"> <li>1116(1): Insulation for exterior walls shall be installed in accordance with the manufacturer's specifications to comply with the California Energy Code, Section 1116(2).</li> <li>1116(2): Insulation for exterior walls shall be installed in accordance with the California Energy Code, Section 1116(3).</li> <li>1116(3): Insulation for exterior walls shall be installed in accordance with the California Energy Code, Section 1116(4).</li> <li>1116(4): Insulation for exterior walls shall be installed in accordance with the California Energy Code, Section 1116(5).</li> <li>1116(5): Insulation for exterior walls shall be installed in accordance with the California Energy Code, Section 1116(6).</li> </ul>	

TROY KASHANIPOUR ARCHITECTURE 2305 3RD STREET SUITE 413, CA 94107, PH: 415.451.0899  
 CLIENT: J.M. COLLECTIVE C/O  
 507 Park Street, Suite 300  
 San Francisco, CA 94102  
 DATE: 07/07/11  
 ISSUED FOR PERMIT  
 CONSULTANT:  
 APPROVAL:  
 DRAWING: TK, SCALE: 1/4"=1'-0"

ACCESSIBILITY STANDARDS TOILET ACCESSORIES AND PARTITION HEIGHTS

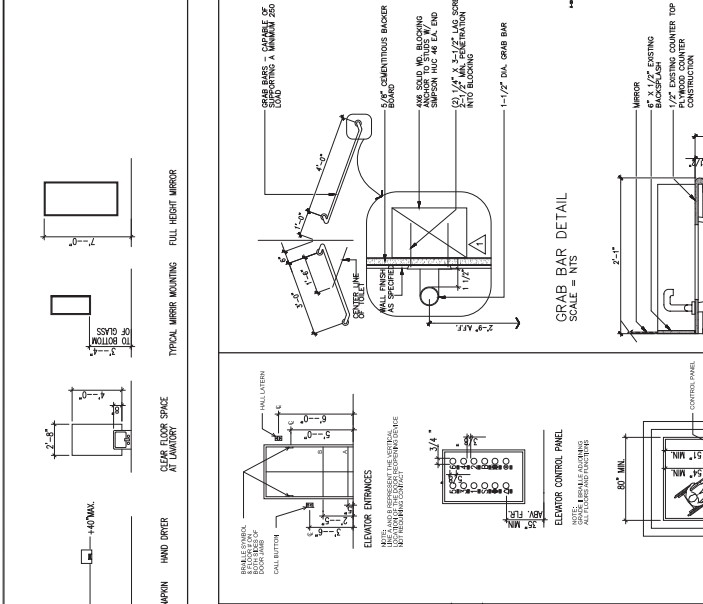

ACCESSIBILITY STANDARDS MISCELLANEOUS ACCESSORIES

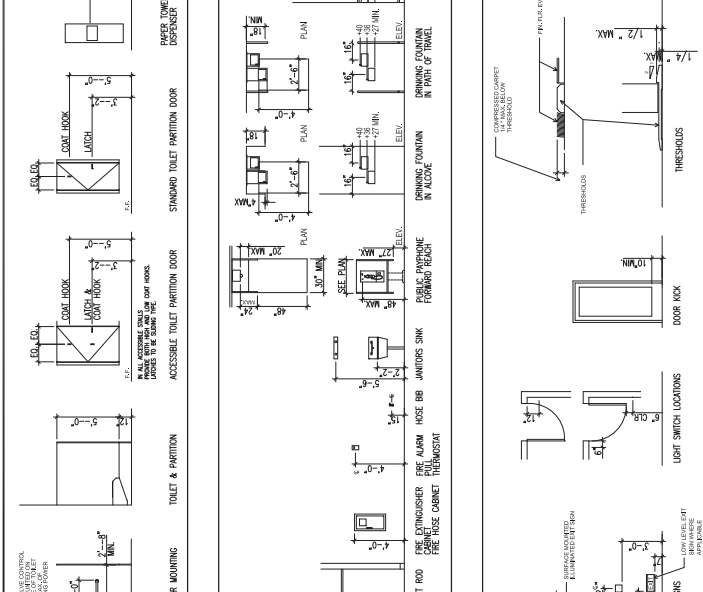

ACCESSIBILITY STANDARDS CLEARANCE AT DOOR, RAILS & WALKS

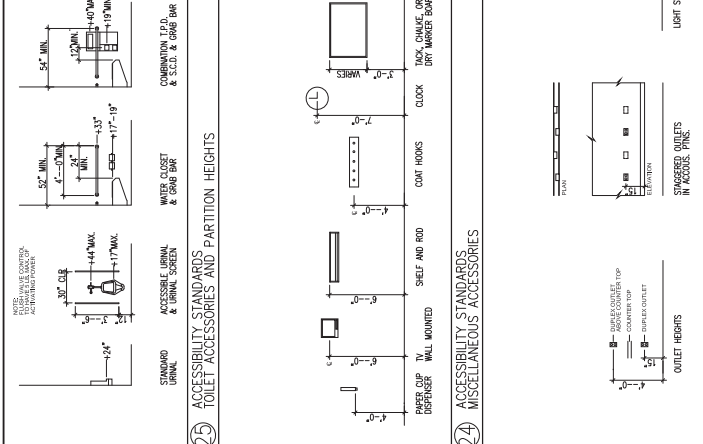

ACCESSIBILITY STANDARDS TOILET ACCESSORIES ENLARGED

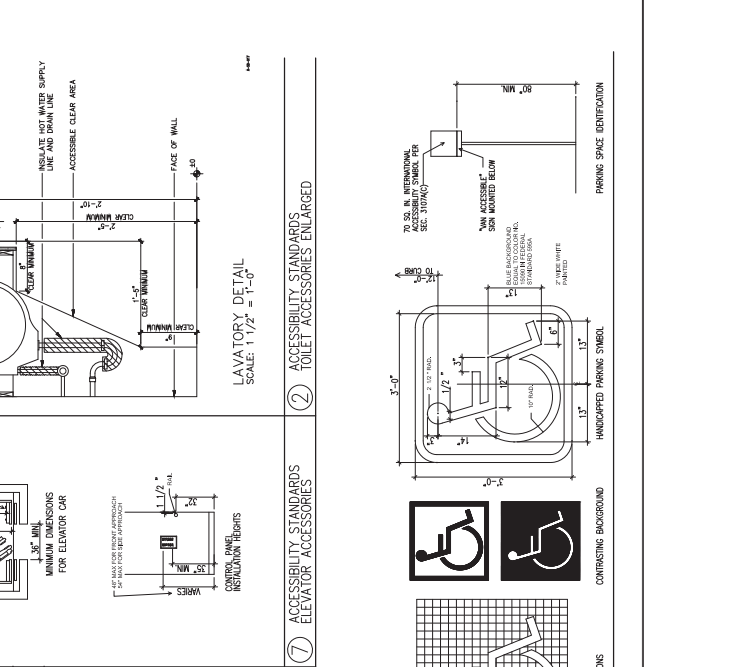

ACCESSIBILITY STANDARDS SIGNAGE, IDENTIFICATION & INTERNATIONAL SYMBOL OF ACCESSIBILITY

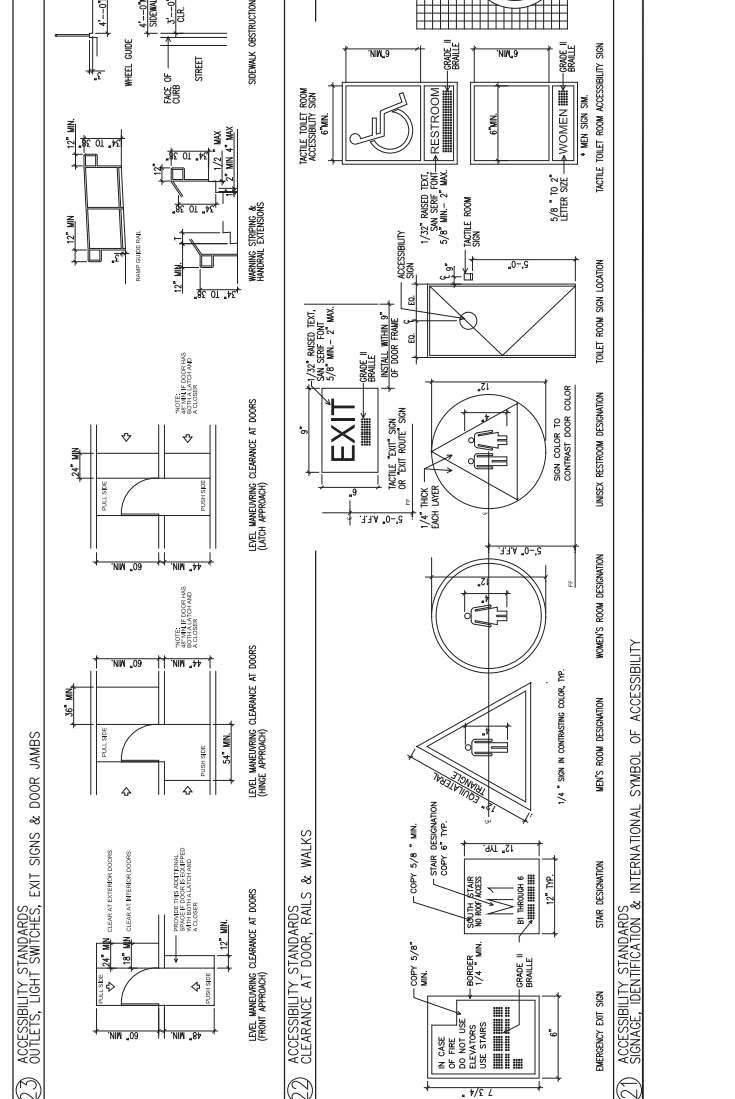



CLIENT: J.M. COLLECTIVE C/O  
 507 Folsom Street, Suite 320  
 San Francisco, CA 94102  
 415.451.0889  
 troykashanipour.com

DATE: 07/07/11  
 ISSUED FOR PERMIT

CONSULTANT:

APPROVAL:

DRAWN:	TK
CHECKED:	TK
SCALE:	1/4"=1'-0"

SEAL: TROY KASHANIPOUR ARCHITECT C. 37446 EXPIRES: 6/30/2011

EXISTING FLOOR PLAN  
 SECTION & ELEVATION

A1.0

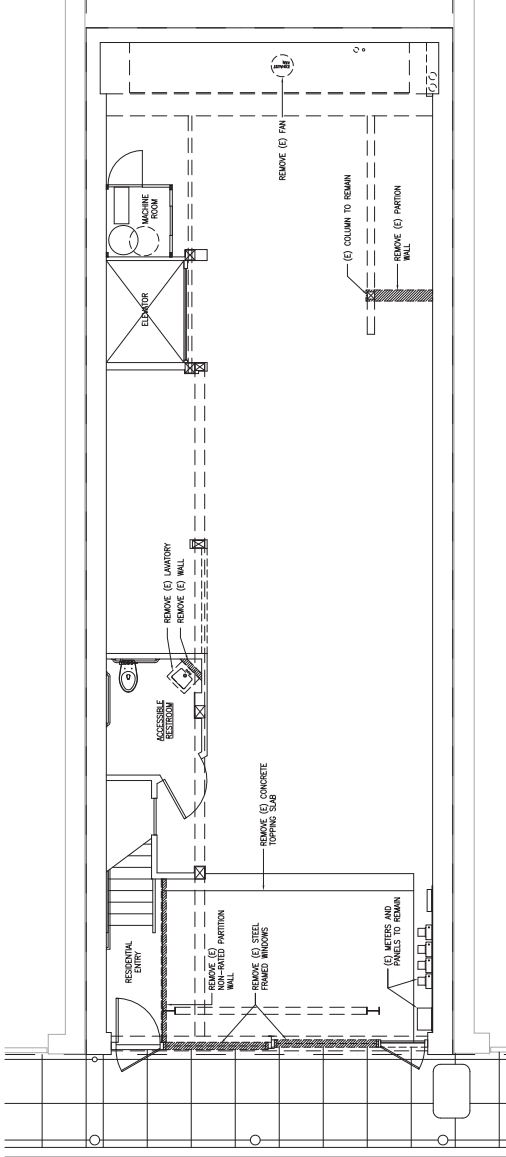

3 EXISTING FLOOR PLAN  
 SCALE: 1/4"=1'-0"

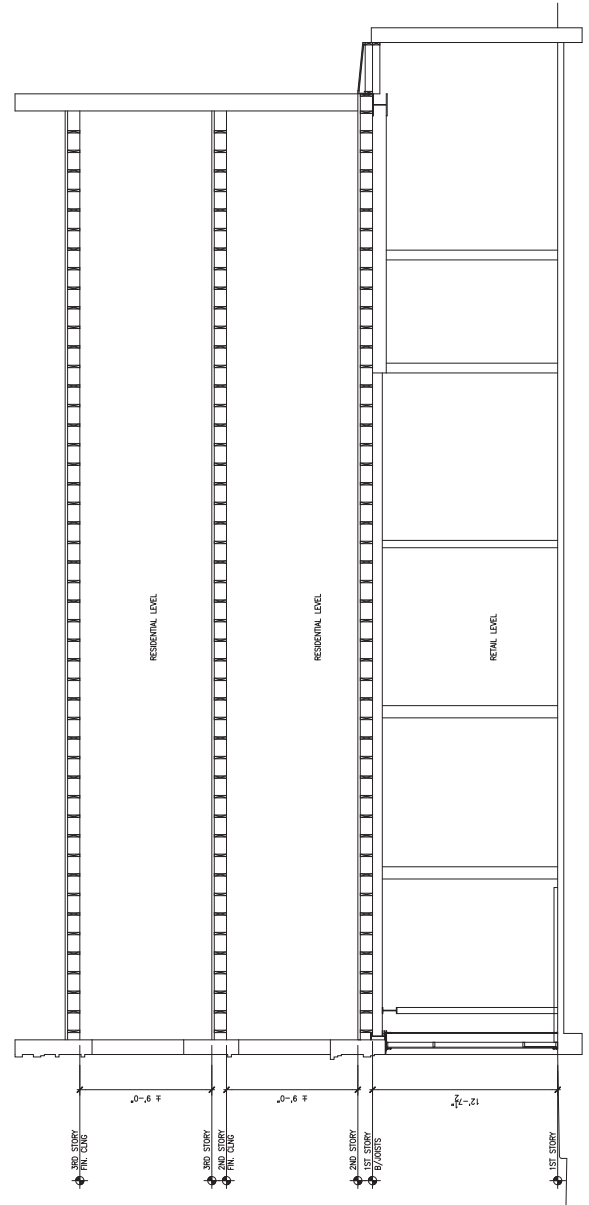

1 EXISTING BUILDING SECTION  
 SCALE: 1/4"=1'-0"

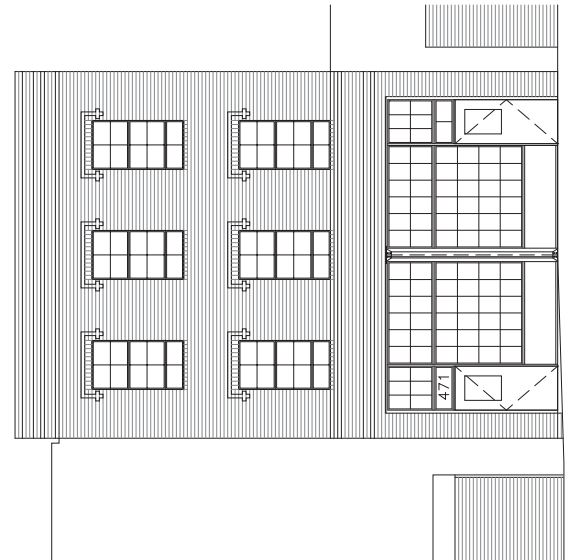

13 EXISTING BUILDING ELEVATION  
 SCALE: 1/4"=1'-0"





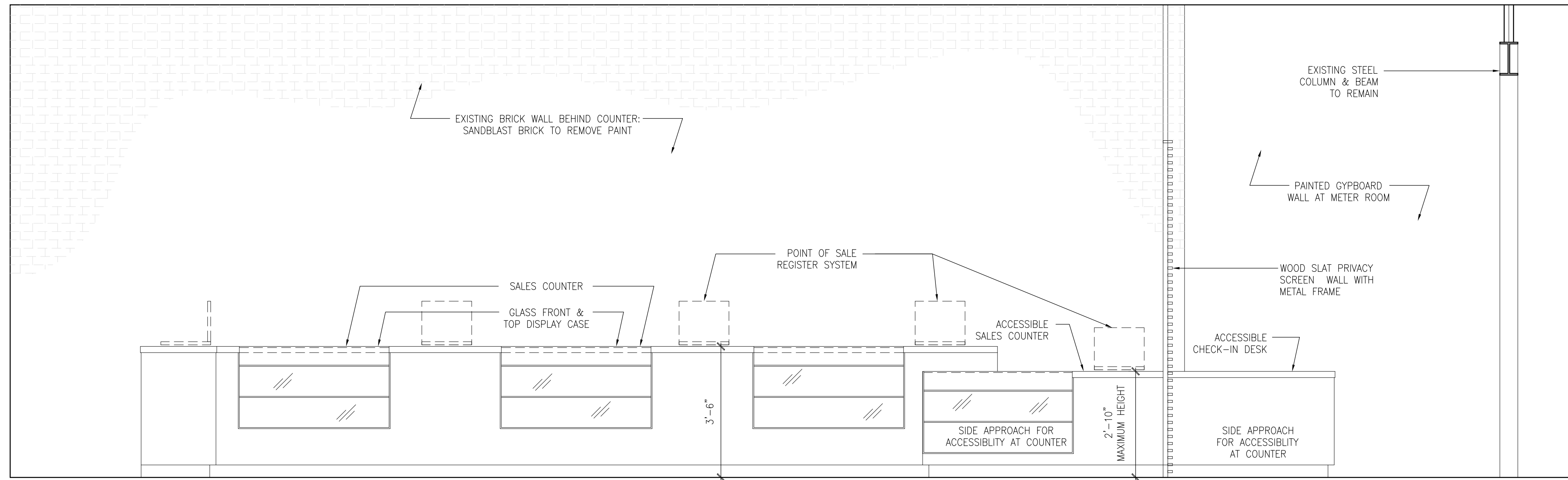

15 ELEVATION AT TRANSACTION COUNTER  
SCALE: 1/2" = 1'-0"

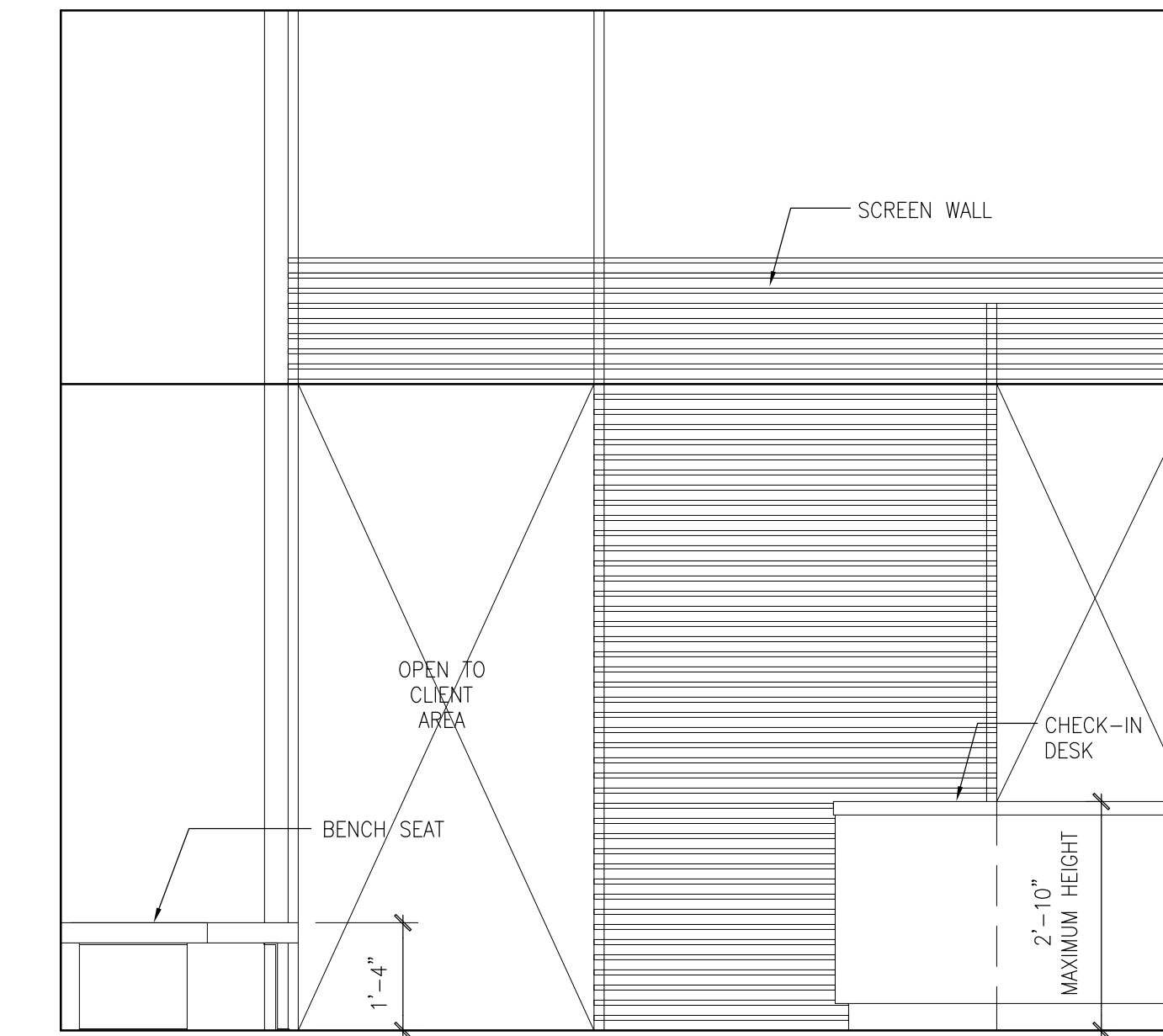

3 ELEVATION AT CHECK-IN AREA  
SCALE: 1/2" = 1'-0"



13 PROPOSED BUILDING ELEVATION  
SCALE: 1/4" = 1'-0"

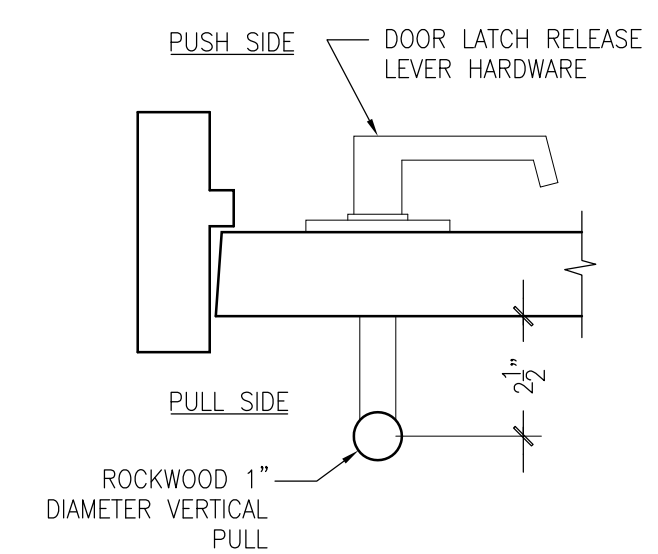

5 SECTION AT DOOR PULL  
SCALE: 3" = 1'-0"

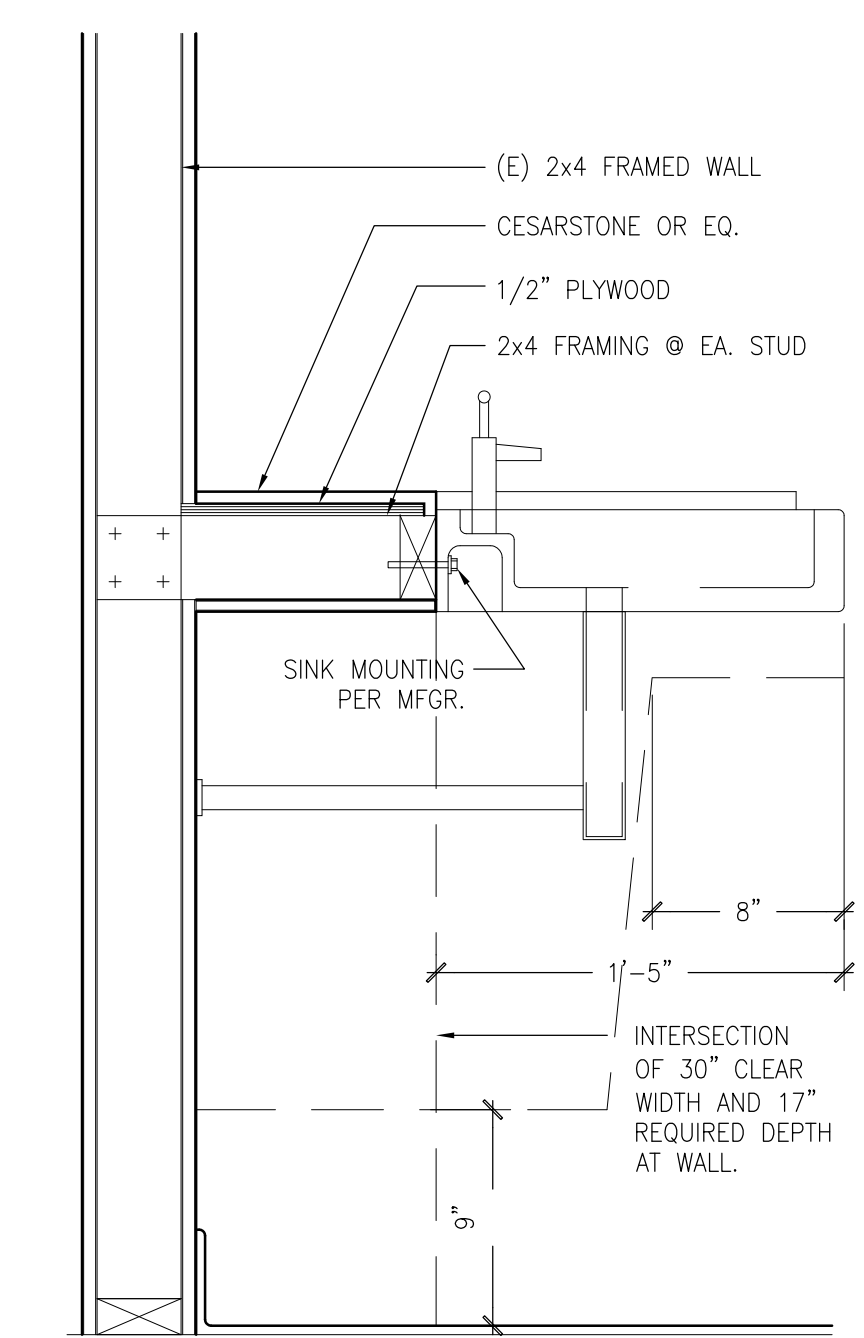
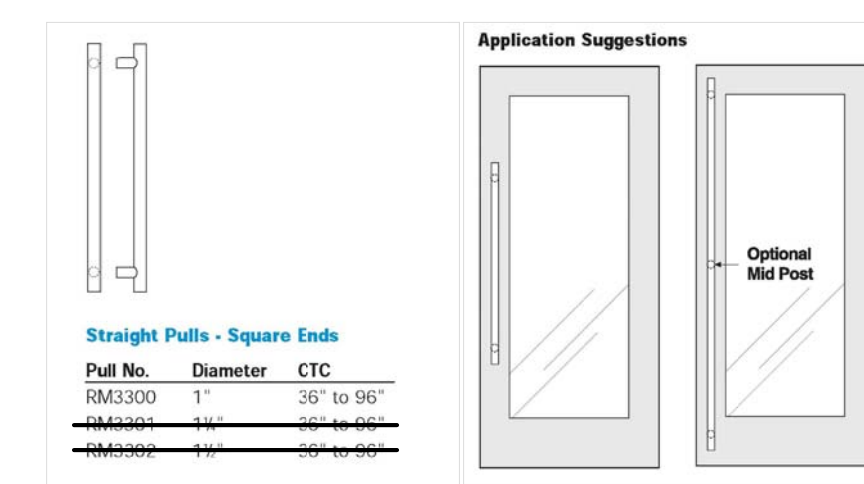

1 SECTION AT WALL MOUNTED LAVATORY  
SCALE: 1 1/2" = 1'-0"

CLIENT: JM COLLECTIVE C/O DANIEL BORNSTEIN  
507 Polk Street, Suite 320  
San Francisco, CA 94102  
PHONE: (415) 409-7611 x13  
Daniel@bornsteinandbornstein.com

ISSUE:	DATE:
ISSUED FOR PERMIT	07.07.11
1 MOD REVISIONS	10.16.11
2 MOD REVISIONS	11.06.11
2 PLANNING REVISION	02.28.12

CONSULTANT:

APPROVAL

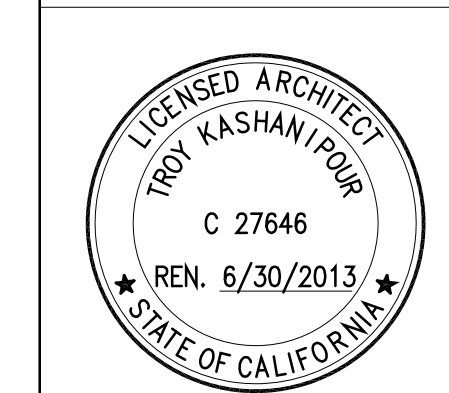

DRAWN: TK  
CHECKED: TK  
SCALE: 1/4" = 1'-0"

PROPOSED ELEVATIONS

A3.0

CLIENT: J.M. COLLECTIVE C/O  
507 Park Street, Suite 320  
San Francisco, CA 94102  
Phone: 415.431.0899  
Email: info@jmkashanipour.com

DATE: 07/20/11  
ISSUED FOR PERMIT  
ISSUE:

CONSULTANT:  
APPROVAL:

DRINK: TK  
CHECKED: TK  
SCALE: 1/4"=1'-0"

LIGHTING PLANS  
A6.0

CLIENT: J.M. COLLECTIVE C/O  
507 Park Street, Suite 320  
San Francisco, CA 94102  
Phone: 415.431.0899  
Email: info@jmkashanipour.com

DATE: 07/20/11  
ISSUED FOR PERMIT  
ISSUE:

CONSULTANT:  
APPROVAL:

DRINK: TK  
CHECKED: TK  
SCALE: 1/4"=1'-0"

LIGHTING PLANS  
A6.0

CLIENT: J.M. COLLECTIVE C/O  
507 Park Street, Suite 320  
San Francisco, CA 94102  
Phone: 415.431.0899  
Email: info@jmkashanipour.com

DATE: 07/20/11  
ISSUED FOR PERMIT  
ISSUE:

CONSULTANT:  
APPROVAL:

DRINK: TK  
CHECKED: TK  
SCALE: 1/4"=1'-0"

LIGHTING PLANS  
A6.0

CLIENT: J.M. COLLECTIVE C/O  
507 Park Street, Suite 320  
San Francisco, CA 94102  
Phone: 415.431.0899  
Email: info@jmkashanipour.com

DATE: 07/20/11  
ISSUED FOR PERMIT  
ISSUE:

CONSULTANT:  
APPROVAL:

DRINK: TK  
CHECKED: TK  
SCALE: 1/4"=1'-0"

LIGHTING PLANS  
A6.0

CLIENT: J.M. COLLECTIVE C/O  
507 Park Street, Suite 320  
San Francisco, CA 94102  
Phone: 415.431.0899  
Email: info@jmkashanipour.com

DATE: 07/20/11  
ISSUED FOR PERMIT  
ISSUE:

CONSULTANT:  
APPROVAL:

DRINK: TK  
CHECKED: TK  
SCALE: 1/4"=1'-0"

LIGHTING PLANS  
A6.0

CLIENT: J.M. COLLECTIVE C/O  
507 Park Street, Suite 320  
San Francisco, CA 94102  
Phone: 415.431.0899  
Email: info@jmkashanipour.com

DATE: 07/20/11  
ISSUED FOR PERMIT  
ISSUE:

CONSULTANT:  
APPROVAL:

DRINK: TK  
CHECKED: TK  
SCALE: 1/4"=1'-0"

LIGHTING PLANS  
A6.0

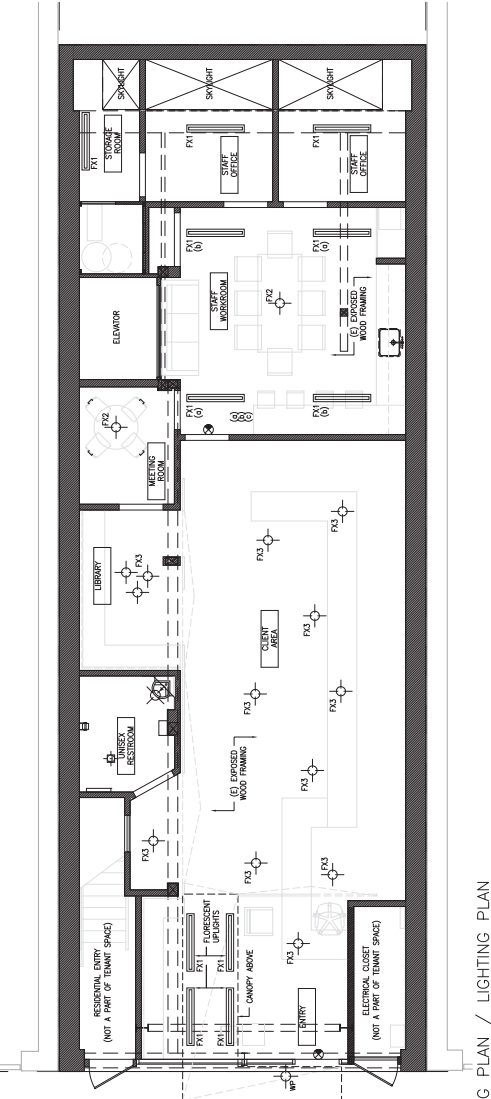

3 PROPOSED CEILING PLAN / LIGHTING PLAN  
SCALE: 1/4"=1'-0"

**LIGHT FIXTURES:**

NOTE: 1. SEE SHEET A6.2 TO MM FOR LIGHTING MANDATORY MEASURES.  
NOTE: 2. ELECTRICAL CONTRACTOR TO DETERMINE AND SPECIFY VOLTAGE FOR THE SCHEDULED FIXTURES.

TYPE	DESCRIPTION	MANUFACTURER	LAMP	QUANTITY	VOLTS	REMARKS
FX1	4' FLUORESCENT 2 LAMP -TS	LIGHTFOUR OR EQUAL	(2) 28W 120V	-	-	-
FX2	RECESSED MOUNTED INCANDESCENT LIGHT FIXTURE	TBD	(1) 75W	-	-	-
FX3	RECESSED MOUNTED INCANDESCENT LIGHT FIXTURE	TBD	(1) 75W	-	-	-
FX4	SURFACE MOUNTED FLUORESCENT LIGHT FIXTURE	TBD	(1) T8 28W 120V	-	-	-

**SYMBOLS**

	CEILING MOUNTED FIXTURE		DOOR TAG
	WALL MOUNTED FIXTURE		CEILING HEIGHT TAG
	EXTERIOR OR WATERPROOF LIGHT FIXTURE		ELEVATION
	WALL WASH LIGHT FIXTURE		FIXTURE TAG
	RECESSED CEILING MOUNTED FIXTURE		P-EQUIPMENT
	FLUORESCENT LIGHT FIXTURE		DRAWING REVISION TAG
	SMOKE DETECTOR		DETAIL KEY
	TELEPHONE		INTERIOR ELEVATION KEY
	INTERIOR		SECTION/ELEVATION KEY
	DUPLEX OUTLET: 1/2 A.F.F.		
	DUPLEX OR OUTLET		
	DUPLEX SWITCHED OUTLET		
	DATA/TELEPHONE OUTLET		
	DOUBLE DUPLEX, COUNTER HT		
	DOUBLE DUPLEX OUTLET: 1/2 A.F.F.		
	COUNTER HEIGHT DUPLEX OUTLET		
	HALF SWITCHED DUPLEX OUTLET		
	DIRECTIONAL EXIT SIGN		
	FAN		
	THERMOSTAT		
	SWITCH		
	DIMMER SWITCH		
	3-WAY SWITCH		